

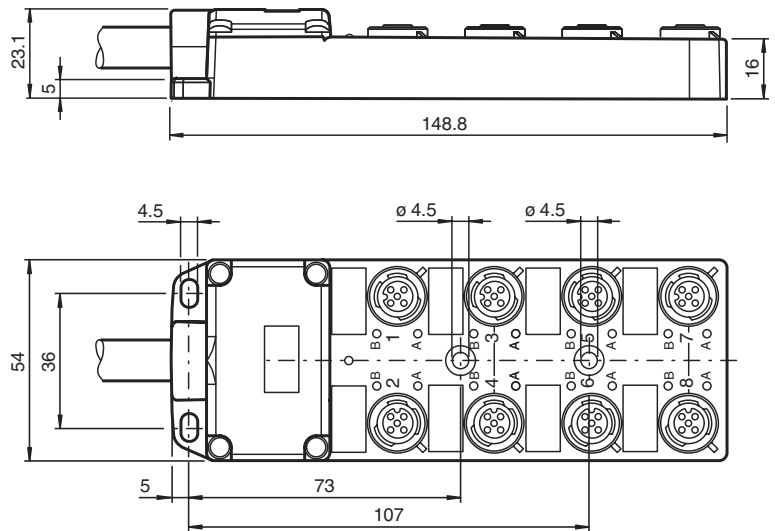

**Dimensions**



**Model Number**

**V1-8/16A-E2-8M-PUR-V23-G**

8-way passive distributor, with M23 plug

**Features**

- LED indicator for module supply and I/O status
- Degree of protection IP67

**Accessories**

**VAZ-V1-B3**

Blind plug for M12 sockets

**MH 05-SACB-8**

Mounting aid for DIN rail

**V15S-T-V15**

Y distributor, M12 connector on M12 socket/socket

**MH V1-SCREWDRIVER**

torque screwdriver (0.4 Nm)

**MH V1-BIT M12**

plug-in cap M12

**Technical data**

**General specifications**

Number of pins	5
----------------	---

**Indicators/operating means**

LED green	supply voltage each module
LED yellow	I/O status indication

**Electrical specifications**

Operating voltage	$U_B$	24 V DC, max. 30 V DC
Operating current	$I_B$	≤ 5 mA per channel indication element
Current loading capacity		≤ 2 A per channel, ≤ 4 A per plug-in station, ≤ 12 A total current per separator

**Ambient conditions**

Ambient temperature	housing: -25 ... 80 °C (-13 ... 176 °F) cable, flexing: -5 ... 80 °C (23 ... 176 °F) cable, fixed: -40 ... 90 °C (-40 ... 194 °F)
---------------------	---

**Mechanical specifications**

Connection type	8 x socket M12 x 1 5-pin 1 x Male connector M23
Degree of protection	IP65/IP67
Connection	Signal and energy: M23 male connector, 12-pin Sensor/actuator: 5-pin, M12 x 1 socket

**Material**

Contacts	Cu alloy
Contact surface	Au
Housing	PBT
Threaded bushings	PBT
Cable	PUR
Seal	O-ring: NBR
Cable	flexible
Sheath diameter	Ø 10.5 mm
Color	black
Cores	12 x 0.75 mm <sup>2</sup>
Length	L 8 m
Flammability	94 V-0

**Compliance with standards and directives**

Standard conformity	
Degree of protection	EN 60529
Flammability	UL 94

Release date: 2014-10-30 11:53 Date of issue: 2015-02-05 226538\_eng.xml

Electrical connection

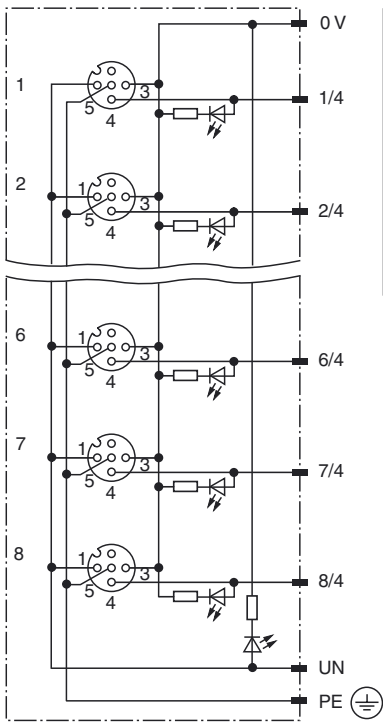

Slot/Pin (signal)	Pin M23
1 / 4	1
2 / 4	2
3 / 4	3
4 / 4	4
5 / 4	5
6 / 4	6
7 / 4	7
8 / 4	8
1-8 / 1	11
1-8 / 3	9
1-8 / 5	12

