



Model Number

M4.2/MV4.2-8000-RT-4922

Thru-beam sensor
with 4-pin, M8 x 1 connector

Features

- High-precision sensors for complex applications
- Miniature design with very robust and versatile mounting options
- Optical surface made of scratch-resistant glass for areas that are prone to high levels of dirt
- Maximum immunity thanks to unique encrypted emission frequency
- Very short response time
- Rear mounting option for easy mounting without mounting bracket
- Aperture for reducing stray light

Dimensions

Transmitter

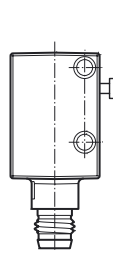

Receiver

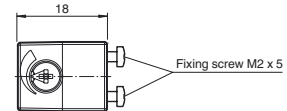
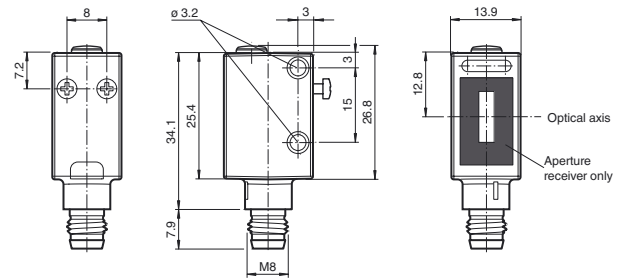

Electrical connection

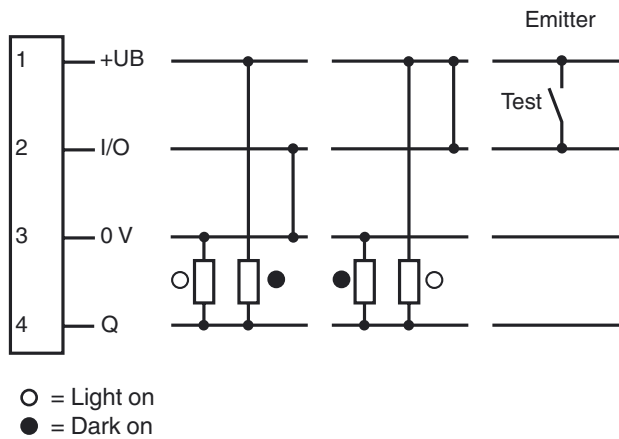

Pinout



Indicators/operating means

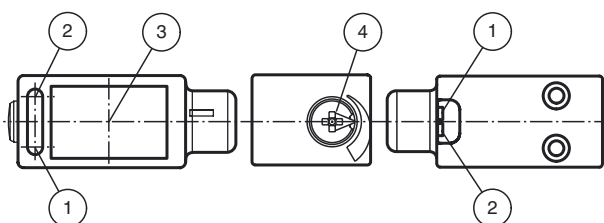

1	Operating display	green
2	Signal display (only Receiver)	yellow
3	Optical axis	
4	Sensitivity adjustment (only Receiver)	

Release date: 2013-05-16 09:48 Date of issue: 2013-05-16 228053_eng.xml

Refer to "General Notes Relating to Pepperl+Fuchs Product Information".

Pepperl+Fuchs Group
www.pepperl-fuchs.com

USA: +1 330 486 0001
fa-info@us.pepperl-fuchs.com

Germany: +49 621 776 4411
fa-info@de.pepperl-fuchs.com

Singapore: +65 6779 9091
fa-info@sg.pepperl-fuchs.com

Technical data**System components**

Emitter	M4.2-8000-RT-4922
Receiver	MV4.2-8000-RT-4922

General specifications

Effective detection range	0 ... 8000 mm
Threshold detection range	10000 mm
Light source	LED
Light type	modulated visible red light
Target size	min. 7 mm
Diameter of the light spot	300 mm at 8000 mm detection range
Angle of divergence	approx. 2 °
Ambient light limit	
Continuous light	40000 Lux
Modulated light	5000 Lux

Functional safety related parameters

MTTF _d	550 a
Mission Time (T _M)	20 a
Diagnostic Coverage (DC)	60 %

Indicators/operating means

Operating display	LED green, statically lit Power on , Undervoltage indicator: Green LED, pulsing (approx. 0.8 Hz) , short-circuit : LED green flashing (approx. 4 Hz)
Function display	LED yellow, lights up with receiver lit flashes when falling short of the stability control
Controls	sensitivity adjustment

Electrical specifications

Operating voltage	U _B	10 ... 30 V DC
Ripple		< 10 %
No-load supply current	I ₀	< 15 mA at 24 V DC

Input

Test input	emitter deactivation at +U _B
------------	---

Output

Switching type	light/dark on electrically switchable	
Signal output	Push-pull output, short-circuit protected, reverse polarity protected	
Switching voltage	max. 30 V DC	
Switching current	max. 100 mA	
Voltage drop	U _d	≤ 2.5 V DC
Switching frequency	f	2000 Hz
Response time		250 μs

Ambient conditions

Ambient temperature	-20 ... 60 °C (-4 ... 140 °F)
Storage temperature	-20 ... 75 °C (-4 ... 167 °F)

Mechanical specifications

Protection degree	IP67 / IP69K
Connection	M8 x 1 connector, 4-pin
Material	
Housing	ABS
Optical face	glass pane
Mass	15 g (device)
Note	For indoor use only The sensor must be protected against UV radiation.

Compliance with standards and directives

Standard conformity	
Product standard	EN 60947-5-2:2007 IEC 60947-5-2:2007
Shock and impact resistance	IEC / EN 60068. half-sine, 40 g in each X, Y and Z directions
Vibration resistance	IEC / EN 60068-2-6. Sinus. 10 -2000 Hz, 10 g in each X, Y and Z directions

Approvals and certificates

CE conformity	yes
UL approval	cULus Listed
CCC approval	CCC approval / marking not required for products rated ≤36 V

Accessories**OMH-4.1**

Mounting Clamp

OMH-ML6

Mounting bracket

OMH-ML6-U

Mounting bracket

OMH-ML6-Z

Mounting bracket

OMH-11-02 Aperture-V-H 0.5 mm

Slit diaphragm can be affixed for detecting very small parts

OMH-11-04 Aperture-V-H 1.0 mm

Slit diaphragm can be affixed for detecting very small parts

OMH-11-06 Aperture-V-H 1.5 mm

Slit diaphragm can be affixed for detecting very small parts

OMH-11-08 Aperture-V-H 2.0 mm

Slit diaphragm can be affixed for detecting very small parts

V31-GM-2M-PVC

M8, 4-pin socket, PVC cable

V31-WM-2M-PVC

M8, 4-pin socket, PVC cable

V31-GM-5M-PUR

4-pin, M8 socket, PUR cable

V31-WM-5M-PUR

4-pin, M8 socket, PUR cable

Other suitable accessories can be found at www.pepperl-fuchs.com

Curves/Diagrams

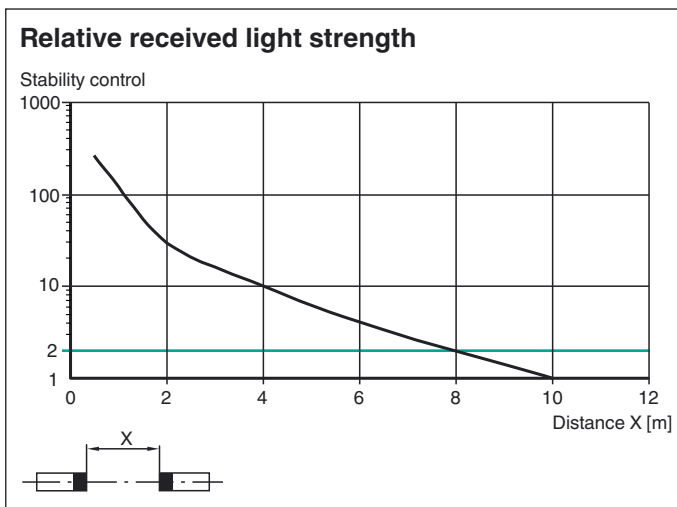
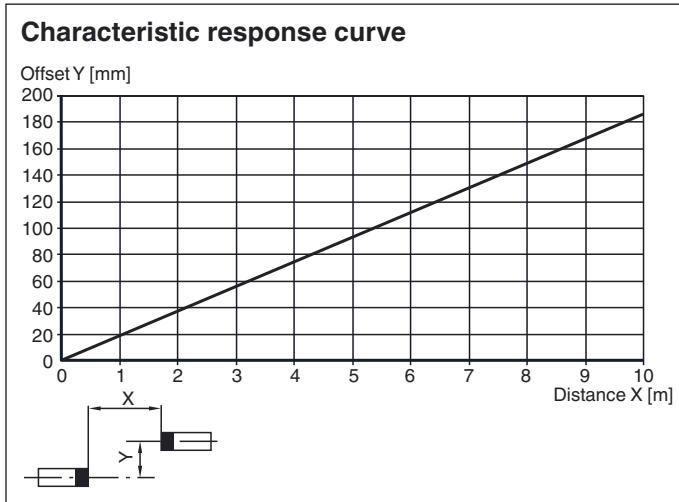

Curves/Diagrams

To aid in the detection of small objects, various apertures OMH-11-... can be placed on the sensors. This results in different detection ranges:

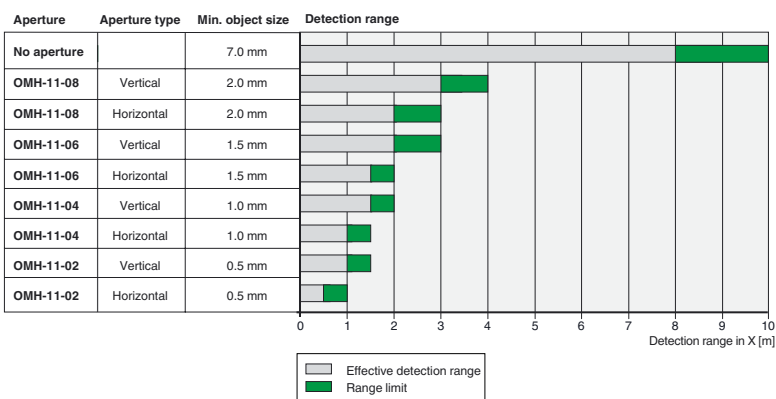

Release date: 2013-05-16 09:48 Date of issue: 2013-05-16 228053_eng.xml

Refer to "General Notes Relating to Pepperl+Fuchs Product Information".

