



### Model Number

#### V1-W-E8W-OR3M-POC

Female cordset, M12, 4-pin, TPE cable, welding-bead resistant

### Features

- Resistant to welding bead formation
- Suitable for robotic applications / torsion resistant
- Does not give off silicone
- Ozone resistant
- Built-in LED, as operating and function indicator
- Knurled nut suitable for tool assembly
- Immunity to vibration, with mechanical latching
- Gold-plated and machined contacts
- Protection degree IP67 / IP68 / IP69K

### Dimensions

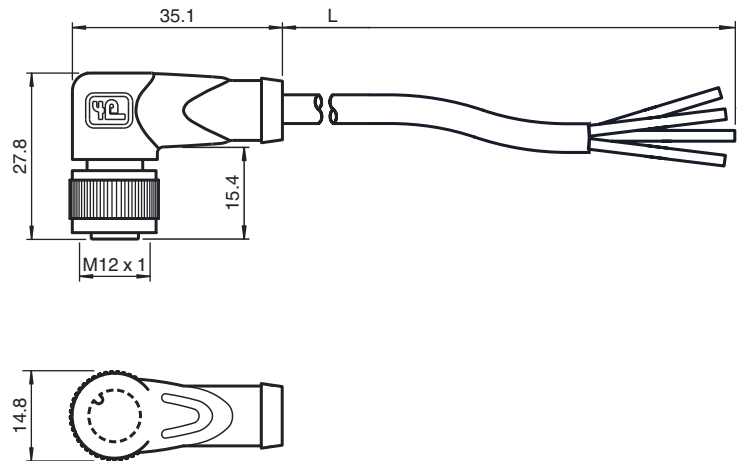

### Technical data

#### General specifications

Number of pins	4
Connection 1	socket
Construction type 1	right angle
Threading 1	M12
Connection 2	cable end

#### Indicators/operating means

LED green	Operating display
LED yellow	Functional display NO contact 4
LED white	Functional display NO contact 2

#### Electrical specifications

Operating voltage	$U_B$	max. 24 V DC $\pm$ 15%
Operating current		max. 4 A
Volume resistance		< 5 m $\Omega$

#### Ambient conditions

Ambient temperature	Body: -40 ... 90 °C (-40 ... 194 °F) Cable, flexing: -15 ... 120 °C (5 ... 248 °F) for 20000 h -15 ... 150 °C (5 ... 302 °F) for 3000 h cable, fixed: -40 ... 120 °C (-40 ... 248 °F) for 20000 h -40 ... 150 °C (-40 ... 302 °F) for 3000 h
---------------------	--

Pollution Degree	3
------------------	---

#### Mechanical specifications

Contact elements	spring-loaded contact socket	
Pin diameter	1 mm	
Protection degree	IP67 / IP68 / IP69K	
Material		
Contacts	CuSn / Au	
Contact surface	Au	
Body	TPU, transparent	
Cable	TPE resistant to welding bead formation	
Slotted nut	Diecast zinc	
Core insulation	ETFE	
Cable	fine-strand, flexible	
Sheath diameter	$\varnothing$ 4.8 mm	
Bending radius	> 10 x cable diameter, moving	
Color	orange	
Cores	4 x 0.34 mm <sup>2</sup>	
Conductor construction	19 x 0.16 mm $\varnothing$	
Length	L	3 m
Flammability		
Contact material	HB	
Housing	V-2	

### Electrical connection

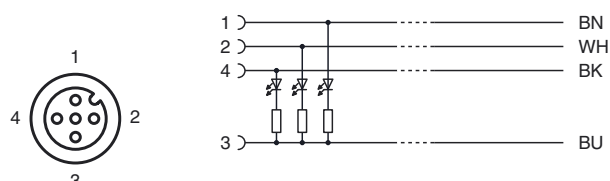



Cable flame-resistant

**Compliance with standards and directives**

Standard conformity	
Protection degree	EN 60529:2000
Standards	IEC 61076-2-101:2008
Flammability	Body: UL 94 Line: UL 1581 Section 1061; IEC 60332-1-2:2004

Release date: 2013-08-14 13:18 Date of issue: 2013-08-14 233461\_eng.xml