



Model Number

V1-W-40M-PVC

Female cordset, M12, 4-pin, PVC cable

Features

- Knurled nut suitable for tool assembly
- Immunity to vibration, with mechanical latching
- Gold plated contacts
- Degree of protection IP67 / IP68 / IP69K

Dimensions

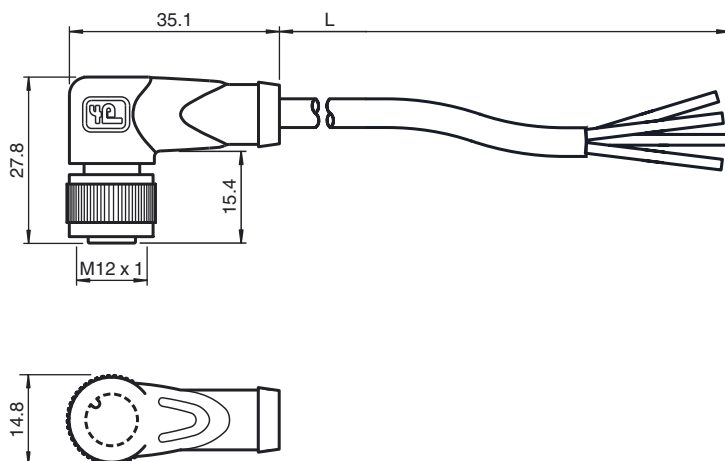

Technical data

General specifications

Number of pins 4

Electrical specifications

Operating voltage U_B max. 250 V AC/DC
 Operating current I_B max. 4 A
 Contact resistance < 10 m Ω

Ambient conditions

Ambient temperature Body: -40 ... 90 °C (-40 ... 194 °F)
 cable, fixed: -25 ... 70 °C (-13 ... 158 °F)
 cable, flexing: -5 ... 70 °C (23 ... 158 °F)

Pollution Degree 3

Mechanical specifications

Contact elements spring-loaded contact socket

Pin diameter 1 mm

Degree of protection IP67 / IP68 / IP69k

Material

Contacts CuSn / Au

Contact surface Au

Body TPU, black

Cable PVC

Slotted nut Diecast zinc

Core insulation PVC

Cable fine-strand, flexible

Sheath diameter \varnothing 4.8 mm

Bending radius > 10 x cable diameter, moving

Color grey

Cores 4 x 0.34 mm²

Conductor construction 19 x 0.15 mm \varnothing

Length L 40 m

Flammability

Contact material 94 HB

Housing 94 V-2

Cable flame-resistant

Compliance with standards and directives

Standard conformity

Degree of protection EN 60529:2000

Standards IEC 61076-2-101:2008

Electrical connection

