

Model Number

V1-W-E8W-3M-PUR

Female cordset, M12, 4-pin, PUR cable

Features

- Built-in LED, as operating and function indicator
- Knurled nut suitable for tool assembly
- Immunity to vibration, with mechanical latching
- Gold-plated and machined contacts
- Protection degree IP67 / IP68 / IP69K
- Halogen-free

Dimensions

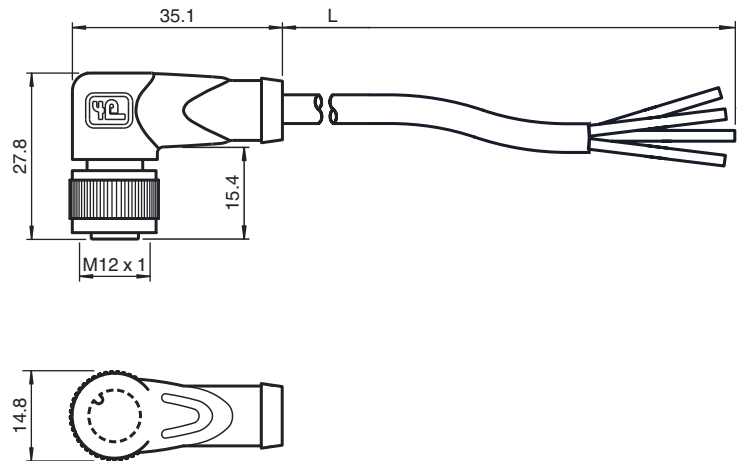

Technical data

General specifications

Number of pins	4
Connection 1	socket
Construction type 1	right angle
Threading 1	M12
Connection 2	cable end

Indicators/operating means

LED green	Operating display
LED yellow	Functional display NO contact 4
LED white	Functional display NO contact 2

Electrical specifications

Operating voltage	U_B	max. 24 V DC \pm 15%
Operating current		max. 4 A
Volume resistance		< 5 m Ω

Ambient conditions

Ambient temperature	Body: -40 ... 90 °C (-40 ... 194 °F) cable, fixed: -40 ... 80 °C (-40 ... 176 °F) cable, flexing: -30 ... 80 °C (-22 ... 176 °F)
Pollution Degree	3

Mechanical specifications

Contact elements	spring-loaded contact socket
Pin diameter	1 mm
Protection degree	IP67 / IP68 / IP69K
Material	
Contacts	CuSn / Au
Contact surface	Au
Body	TPU, transparent
Cable	PUR
Slotted nut	Diecast zinc
Core insulation	PP
Cable	fine-strand, flexible
Sheath diameter	\varnothing 4.8 mm
Bending radius	> 10 x cable diameter, moving
Color	grey
Cores	4 x 0.34 mm ²
Conductor construction	19 x 0.15 mm \varnothing
Length	L 3 m
Flammability	
Contact material	94 HB
Housing	94 V-2

Electrical connection

