



Model Number

V11-W-BK2M-PUR-U

Female cordset, M12, 3-pin, PUR cable

Features

- Knurled nut suitable for tool assembly
- Immunity to vibration, with mechanical latching
- Gold plated contacts
- Degree of protection IP67 / IP68 / IP69K

Dimensions

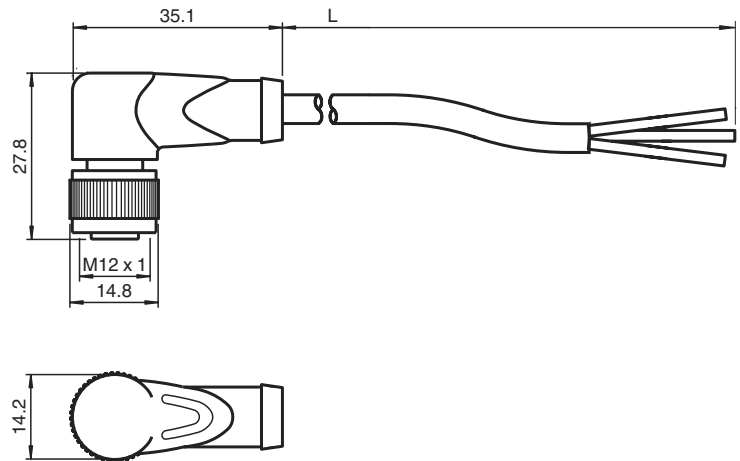

Technical data

General specifications

Number of pins	3
----------------	---

Electrical specifications

Volume resistance	< 5 mΩ
-------------------	--------

Ambient conditions

Ambient temperature	Body: -40 ... 90 °C (-40 ... 194 °F)
Pollution Degree	3

Mechanical specifications

Contact elements	spring-loaded contact socket
Pin diameter	1 mm
Degree of protection	IP67 / IP68 / IP69k
Material	
Contacts	CuSn / Au
Contact surface	Au
Body	TPU, black
Cable	PUR
Slotted nut	Diecast zinc

Cable	
Length	L 2 m

Flammability	
Contact material	HB
Housing	V-2

Compliance with standards and directives

Standard conformity	
Degree of protection	EN 60529:2000
Standards	IEC 61076-2-101:2008
Flammability	Grip: UL 94

Electrical connection

