



Model Number

V11-W-BK5M-PVC-U

Female cordset, M12, 3-pin, PVC cable

Features

- UL Recognized Component
- Knurled nut suitable for tool assembly
- Immunity to vibration, with mechanical latching
- Gold plated contacts
- Degree of protection IP67 / IP68 / IP69K

Dimensions

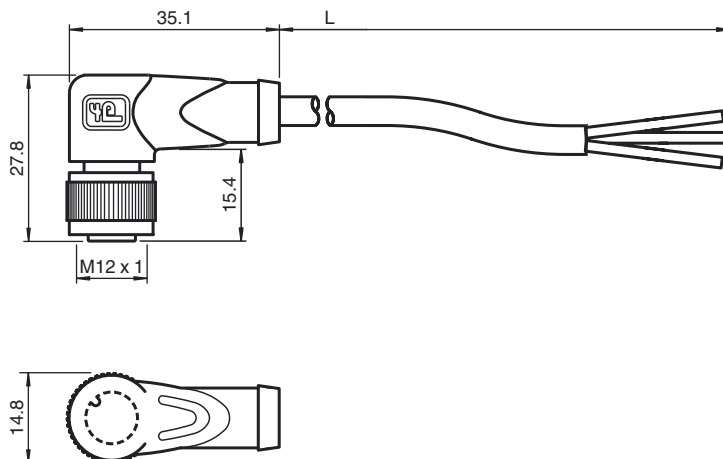

Technical data

General specifications

Number of pins	3
UL File Number	E231213

Electrical specifications

Operating voltage	U_B	max. 250 V AC/DC
Operating current	I_B	max. 4 A
Contact resistance		< 10 m Ω

Ambient conditions

Ambient temperature	Body: -40 ... 90 °C (-40 ... 194 °F) cable, flexing: -25 ... 80 °C (-13 ... 176 °F) cable, fixed: -5 ... 80 °C (23 ... 176 °F)
Pollution Degree	3

Mechanical specifications

Contact elements	spring-loaded contact socket
Pin diameter	1 mm
Degree of protection	IP67 / IP68 / IP69k

Material

Contacts	CuSn / Au
Contact surface	Au
Body	TPU, black
Cable	PVC
Slotted nut	Diecast zinc
Core insulation	PVC
Cable	fine-strand, flexible
Sheath diameter	\varnothing 4.3 mm
Bending radius	> 15 x cable diameter, induced > 5 x cable diameter, fixed

Color	black
Cores	3 x 0.34 mm ²
Conductor construction	19 x 0.15 mm \varnothing
Length	L 5 m

Flammability

Contact material	94 HB
Housing	94 V-2
Cable	FT1

Compliance with standards and directives

Standard conformity	
Degree of protection	EN 60529:2000
Standards	IEC 61076-2-101:2008
Flammability	Body: UL 94 Line: UL 1581 Section 1061; IEC 60332-1-2:2004

Electrical connection

