

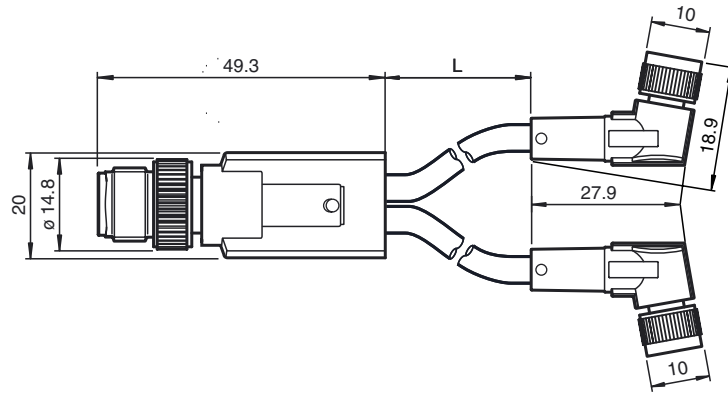

Dimensions



Model Number

V3-WM-2M-PUR-TV1-G

Y connecting cable, M12 to 2 x M8, 3-pin, PUR cable

Features

- Simple assembling of 2 signals to one M12 plug-in station
- Immunity to vibration
- Halogen-free

Technical data

General specifications

Number of pins 3

Electrical specifications

Operating voltage U_B max. 60 V DC

Operating current max. 4 A

Volume resistance < 5 m Ω

Ambient conditions

Ambient temperature -5 ... 80 °C (23 ... 176 °F) active
-25 ... 80 °C (-13 ... 176 °F) static

Pollution Degree 3

Mechanical specifications

Degree of protection IP65 / IP68 / IP69K

Connection 1 x M12 connector, straight
2 x M8 socket, straight

Material

Contacts CuSn

Contact surface Ni/Au

Connector TPU

Body TPU, black

Cable PUR

Slotted nut Zinc die-casting, nickel-plated

Sleeve connector Zinc die-casting, nickel-plated

Cable

Sheath diameter \varnothing 4.4 mm

Color dark grey (RAL 7021)

Cores 3 x 0.25 mm²

Length L 2 m

Electrical connection

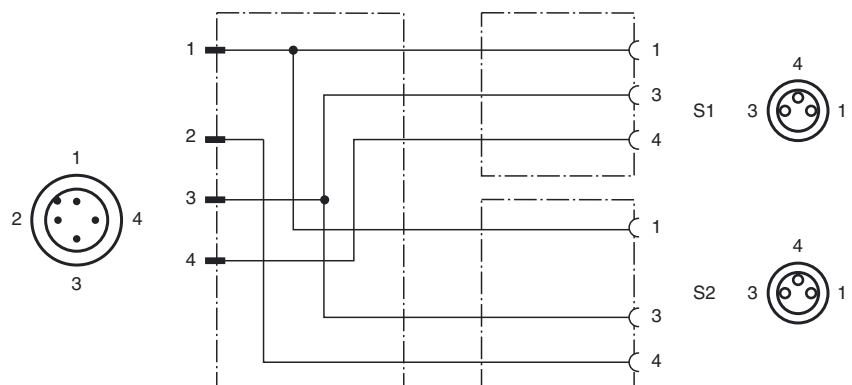

Release date: 2014-11-04 09:20 Date of issue: 2014-11-04 245544_eng.xml