

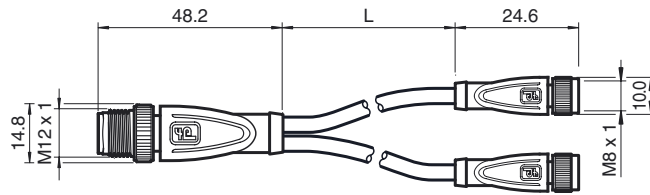

**Dimensions**



**Model Number**

**V3-GM-2M-PUR-TV1-G**

Y connecting cable, M12 to 2 x M8, 3-pin, PUR cable

**Features**

- Simple assembling of 2 signals to one M12 plug-in station
- Immunity to vibration
- Halogen-free

**Technical data**

**General specifications**

Number of pins 3

**Electrical specifications**

Operating voltage  $U_B$  max. 60 V DC  
 Operating current max. 4 A  
 Volume resistance < 5 m $\Omega$

**Ambient conditions**

Ambient temperature -5 ... 80 °C (23 ... 176 °F) active  
 -25 ... 80 °C (-13 ... 176 °F) static  
 Pollution Degree 3

**Mechanical specifications**

Degree of protection IP65 / IP68 / IP69K  
 Connection 1 x M12 connector, straight  
 2 x M8 socket, straight

**Material**

Contacts CuSn  
 Contact surface Ni/Au  
 Connector TPU  
 Body TPU, black  
 Cable PUR  
 Slotted nut Zinc die-casting, nickel-plated  
 Sleeve connector Zinc die-casting, nickel-plated

**Cable**

Sheath diameter  $\varnothing$  4.4 mm  
 Color dark grey (RAL 7021)  
 Cores 3 x 0.25 mm<sup>2</sup>  
 Length L 2 m

**Electrical connection**

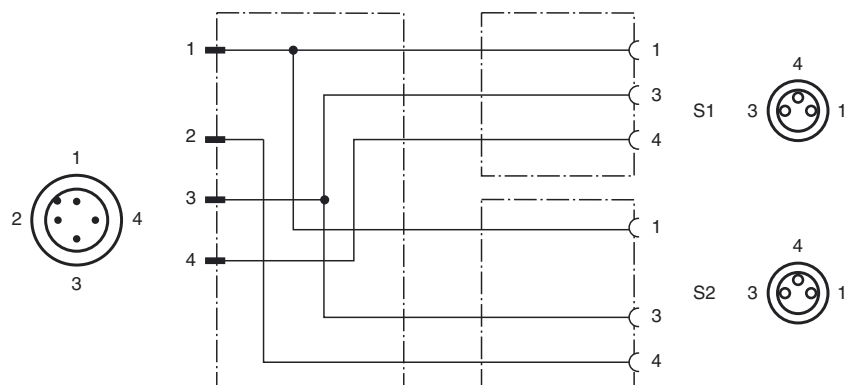

Release date: 2014-11-04 09:20 Date of issue: 2014-11-04 245550\_eng.xml