

Dimensions

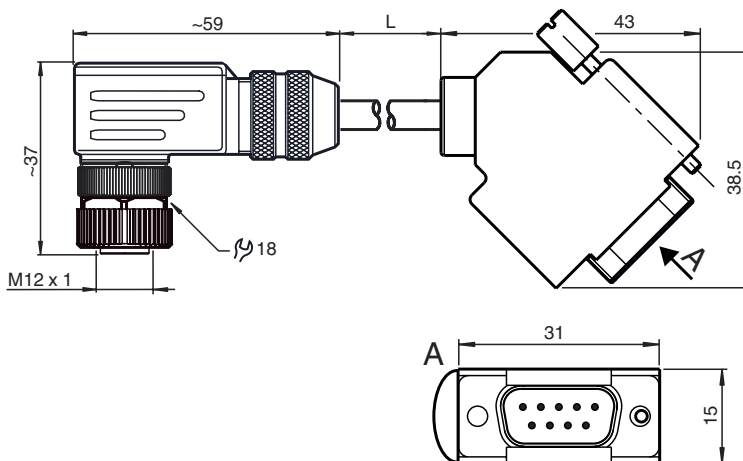

Model Number

V19-W-3M-PUR-ABG-SUBD9-W-Y

Connection cable, M12 to SUB-D, PUR cable 8-pin, shielded

Features

- Iris spring screening
- Metal housing
- Halogen-free
- Shield attached to coupling nut
- Bus termination resistor

Technical data

General specifications

Number of pins	8 + shield
Connection 1	female connector
Construction type 1	right angle
Threading 1	M12
Connection 2	Male connector
Construction type 2	right angle
Threading 2	Sub-D

Electrical specifications

Operating voltage	U_B	max. 30 V AC/DC
Test voltage		> 1500 V _{eff} AC
Operating current		max. 1.5 A
Volume resistance		< 5 mΩ

Ambient conditions

Ambient temperature	-20 ... 80 °C (-4 ... 176 °F)
Pollution Degree	3

Mechanical specifications

Contact elements	spring-loaded contact socket, pins
Pin diameter	1 mm
Protection degree	IP20 (Sub-D connector) IP67 (M12 socket)

Material	
Contacts	CuZn Ni/Au
Contact surface	Au
Body	Zinc die-casting, nickel-plated metallized plastic
Cable	PUR
Slotted nut	Zinc die-casting, nickel-plated
Core insulation	PP
Cable	
Cable	fine-strand, flexible
Sheath diameter	Ø 6 mm
Bending radius	Cable, moving: 60 mm, Cable, fixed: 30 mm
Color	grey
Cores	8 x 0.25 mm ²
Conductor construction	19 x 0.127 mm Ø
Shield	grid covering 85 %
Length	L 3 m
Flammability	
Contact material	94 HB
Housing	94 V-2 / 94 V-0

Electrical connection

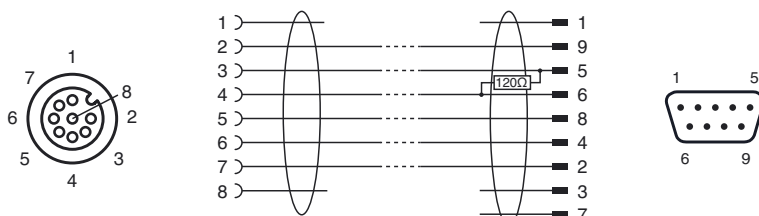

Release date: 2012-06-18 14:02 Date of issue: 2012-06-19 247910_eng.xml

Subject to modifications without notice

Pepperl+Fuchs Group
www.pepperl-fuchs.com

USA: +1 330 486 0001
fa-info@us.pepperl-fuchs.com

Germany: +49 621 776-4411
fa-info@pepperl-fuchs.com

Copyright Pepperl+Fuchs
Singapore: +65 6779 9091
fa-info@sg.pepperl-fuchs.com

pepperl+fuchs
SENSING YOUR NEEDS