



**Model Number**

**PHA250-F200A-R2-T**

Precision positioning on hole in the 70 mm x 70 mm housing

**Features**

- Large capture range
- High operating range
- Integrated contrast compensation
- Compact design
- Integrated illumination
- Detects the position of an index hole

**Function**

The sensor has been developed for the precision positioning of high-bay racking operating equipment. It detects circular holes in the racking structure and their positional deviation from the nominal position. The sensor operates in two dimensions.

**Indicating / Operating means**

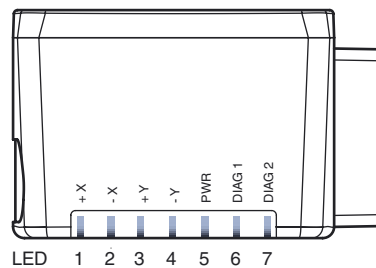
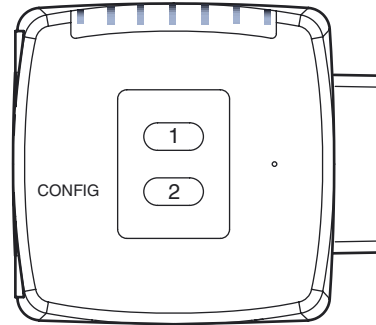

**Electrical connection**

**RS 232**



Pin	Signal
1	+UB
2	TX RS232
3	GND
4	RX RS232
5	NC

**LAN**

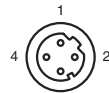

Pin	Signal
1	TX+ Ethernet
2	RX+ Ethernet
3	TX- Ethernet
4	RX- Ethernet

**24 V DC+IO**



Pin	Signal
1	OUT +X
2	+UB
3	OUT -Y
4	OUT +Y
5	OUT -X
6	IN 1
7	GND
8	IN 2

Release date: 2013-09-06 13:06 Date of issue: 2013-09-06 248687\_eng.xml

Refer to "General Notes Relating to Pepperl+Fuchs Product Information".

**Technical data****General specifications**

Light source	LED
Light type	Integrated LED lightning (infrared)
Object size	Hole diameter 13 mm
Response delay	100 ms
Read distance	250 mm
Depth of focus	± 50 mm
Capture range	max. 120 mm x 100 mm

**Nominal ratings**

Camera	
Type	CMOS , Global shutter
Number of pixels	752 x 480 pixels
Gray scale	256

**Functional safety related parameters**

MTTF <sub>d</sub>	70 a
Mission Time (T <sub>M</sub> )	10 a
Diagnostic Coverage (DC)	0 %

**Indicators/operating means**

Operating display	LED green: Ready for operation
Function display	4 x LED yellow: +X, -X, +Y, -Y
Controls	none

**Electrical specifications**

Operating voltage	U <sub>B</sub>	24 V DC ± 15% , PELV
No-load supply current	I <sub>0</sub>	max. 250 mA
Power consumption	P <sub>0</sub>	6 W

**Interface**

Interface type	serial , RS 232
Transfer rate	max. 115.2 kBit/s
Cable length	max. 30 m

**Interface 1**

Interface type	Ethernet
Protocol	TCP/IP
Transfer rate	100 MBit/s
Cable length	max. 30 m

**Input**

Input voltage	to be applied externally 24 V ± 15% PELV
Number/Type	Cycle stop, relative stroke
Input current	1.6 mA at 24 V
Switching threshold	low: < 10 V, high: > 15 V
Cable length	max. 30 m

**Output**

Switching type	PNP , short-circuit/overload protected
Signal output	+X, -X, +Y, -Y
Switching voltage	24 V
Switching current	max. 100 mA each output
Cable length	max. 30 m

**Ambient conditions**

Operating temperature	0 ... 60 °C (32 ... 140 °F) , -30 ... 60 °C (-22 ... 140 °F) (noncondensing; prevent icing on the lens!)
Storage temperature	-30 ... 85 °C (-22 ... 185 °F)
Relative humidity	90 % , noncondensing
Shock resistance	< 50 g
Vibration resistance	< 3 G , 11 ... 200 Hz

**Mechanical specifications**

Protection degree	IP67
Connection	8-pin, M12x1 connector, standard (supply+IO) , 5-pin, M12x1 socket, standard (RS 232) , 4-pin, M12x1 socket, standard (LAN)
Material	
Housing	PC/ABS
Optical face	Plastic pane
Installation	4 x M6 threading
Mass	approx. 160 g

**Compliance with standards and directives**

Directive conformity	
EMC Directive 2004/108/EC	EN 61326-1 , EN 61000-6-4
Standard conformity	
Noise immunity	EN 61326-1:2006
Emitted interference	EN 61000-6-4:2007/A1:2011

**Accessories****V19-G-BK5M-PUR-U/ABG**

Female cordset, M12, 8-pin, PUR-cable

**CBL-PUR-ABG-GY-04x034-100M**

Cable, PUR/PP, 4-pin, shielded

**V45-G**

Field-attachable male connector

**V1-G-2M-PUR-ABG-V1-W-UL**

Connecting cable, M12 to M12, PUR cable 4-pin, shielded

**PCV-MB1**

Mounting bracket for PCV\* read head

Other suitable accessories can be found at [www.pepperl-fuchs.com](http://www.pepperl-fuchs.com)

Curves / Diagrams

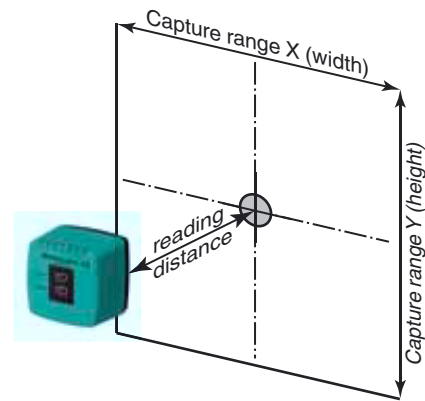

Dimensions

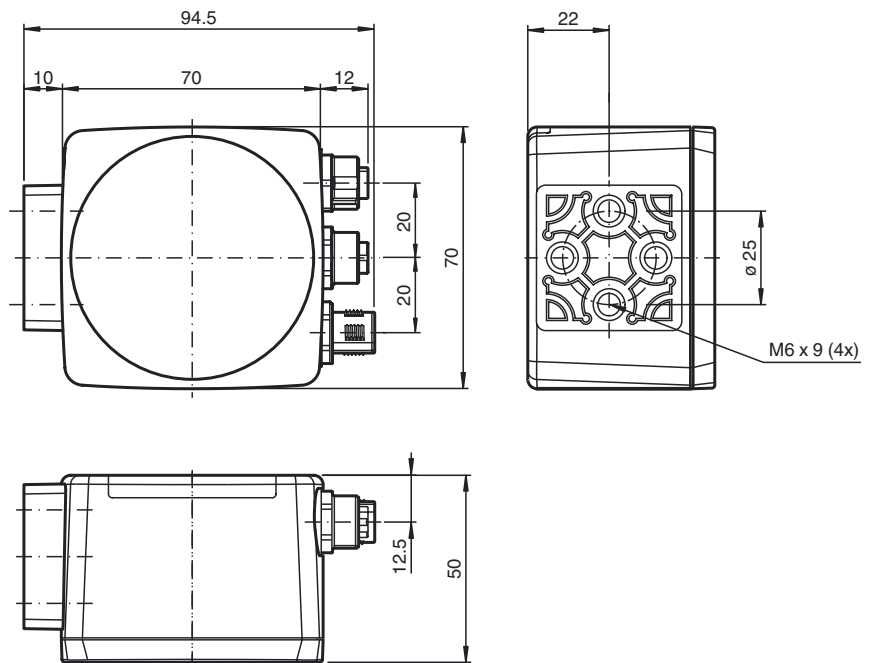

Release date: 2013-09-06 13:06 Date of issue: 2013-09-06 248687\_eng.xml

Refer to "General Notes Relating to Pepperl+Fuchs Product Information".

Pepperl+Fuchs Group  
www.pepperl-fuchs.com

USA: +1 330 486 0001  
fa-info@us.pepperl-fuchs.com

Germany: +49 621 776 4411  
fa-info@de.pepperl-fuchs.com

Singapore: +65 6779 9091  
fa-info@sg.pepperl-fuchs.com