



Model Number

VMA-2+P/Z2-15M-PUR-V1-G

Valve connector, Form A, 2+PE, Z diode, PUR cable to M12 round connector

Features

- Valve connector according EN 175301-803 A/ISO 4400 (previously DIN 43650)
- Z diode as a protective circuit
- Built-in LED, as operating and function indicator
- Moulded seal
- freely selectable cable models due to bridged protective earth
- Flame resistant cable
- Halogen-free

Dimensions

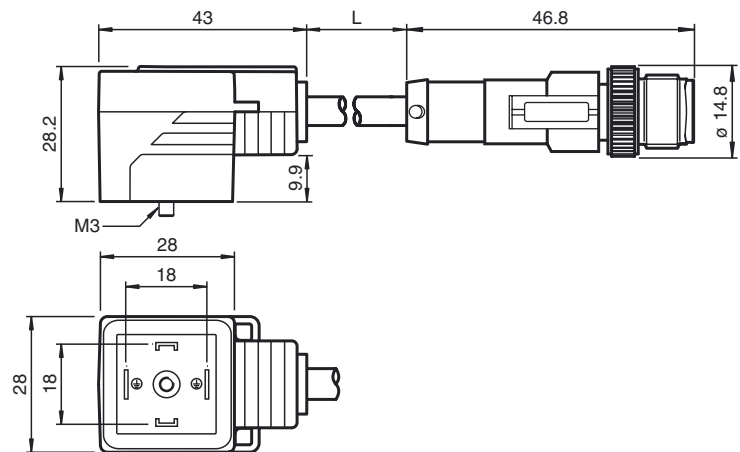

Technical data

General specifications

Number of pins 2 + PE

Indicators/operating means

LED yellow Functional display

Electrical specifications

Operating voltage U_B 24 V AC/DC

Operating current I_B max. 4 A

Volume resistance < 5 m Ω

Ambient conditions

Ambient temperature Body: -20 ... 85 °C (-4 ... 185 °F)
cable, flexing: -20 ... 80 °C (-4 ... 176 °F)
cable, fixed: -40 ... 80 °C (-40 ... 176 °F)

Pollution Degree 3

Mechanical specifications

Degree of protection IP65/IP67

Connection Valve connector Form A

Material

Contacts CuSn
Contact surface Sn
Body TPU, black
Cable PUR
Core insulation PP

Cable

Sheath diameter \varnothing 4.5 mm
Bending radius > 50 mm
> 22.5 mm, fixed

Color black
Cores (2 + 1) x 0.5 mm²; 20 AWG
Conductor construction 28 x 0.15 mm \varnothing
Length L 15 m

Electrical connection

