

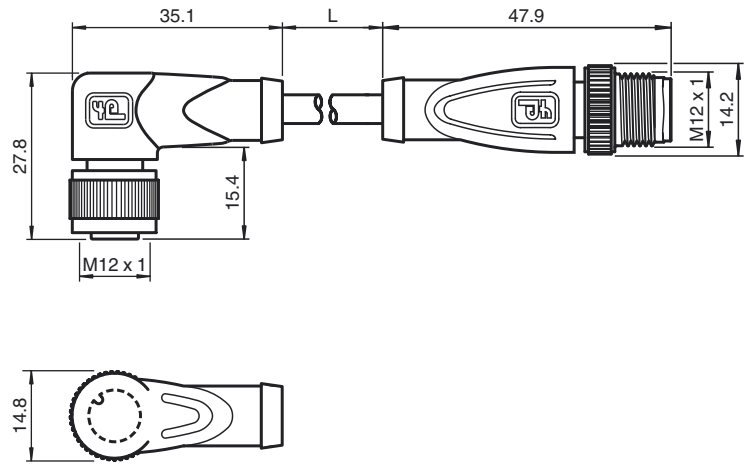

Dimensions



Model Number

V1-W-BK2M-PUR-A-V1-G

Connection cable, M12 to M12, PUR cable, 4-pin

Features

- Improved resistance to weld slag
- Suitable for drag chains
- Suitable for robotic applications / torsion resistant
- Flame resistant cable
- Halogen-free
- Resistant to microbes and hydrolysis
- Free of paint coating substances
- Immunity to vibration, with mechanical latching
- Knurled nut suitable for tool assembly

Technical data

General specifications

Number of pins 4

Electrical specifications

Operating voltage U_B max. 250 V AC/DC
 Operating current I_B max. 4 A
 Volume resistance < 5 m Ω

Ambient conditions

Ambient temperature Body: -40 ... 90 °C (-40 ... 194 °F)
 cable, fixed: -40 ... 80 °C (-40 ... 176 °F)
 cable, flexing: -25 ... 80 °C (-13 ... 176 °F)

Pollution Degree 3

Mechanical specifications

Contact elements spring-loaded contact socket

Pin diameter 1 mm

Degree of protection IP67

Material

Contacts CuSn / Au

Contact surface Au

Body TPU, black

Cable PUR

Slotted nut Diecast zinc

Sleeve connector Diecast zinc

Core insulation PP

Cable extra-fine wire, flexible

Sheath diameter \varnothing 4.3 mm

Bending radius > 10 x cable diameter, moving
 > 5 x cable diameter, fixed

Color black

Cores 4 x 0.34 mm²

Conductor construction 42 x 0.1 mm \varnothing

Length L 2 m

Drag chain suitability

Drag chain cycles \geq 5000000 (at max. 60 °C)

Motion velocity \leq 3.3 m/s

Traverse distance 5 m horizontal

Acceleration \leq 5 m/s²

Torsion cycles \geq 1000000 (at max. 60 °C)

Torsional stress \pm 180 °/m

Flammability

Contact material 94 HB

Housing 94 V-2

Cable FT2

Compliance with standards and directives

Electrical connection

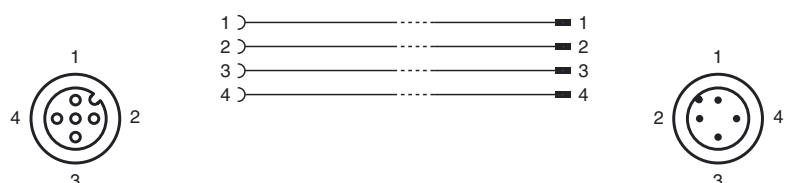

Release date: 2015-01-12 14:01 Date of issue: 2015-01-12 252982_eng.xml



Standard conformity	
Degree of protection	EN 60529:2000
Standards	IEC 61076-2-101:2008
Flammability	Body: UL 94 Line: UL 1581 Section 1061; IEC 60332-1-2:2004
Halogen-free	IEC 60754-1:1994

Release date: 2015-01-12 14:01 Date of issue: 2015-01-12 252982_eng.xml