

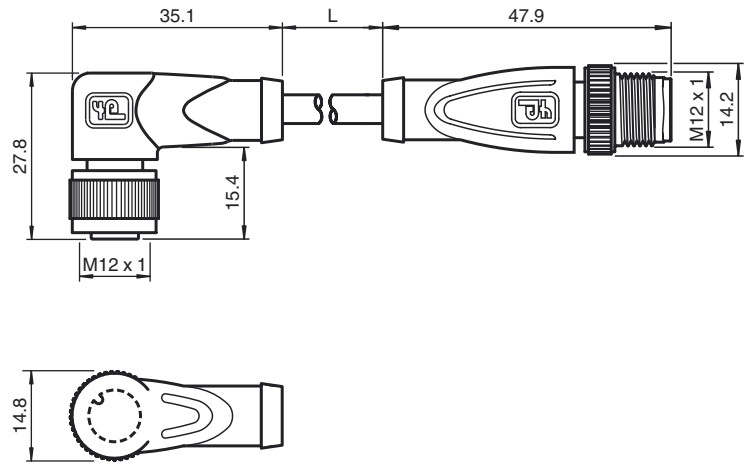

**Dimensions**



**Model Number**

**V1-W-BK3M-PUR-A-V1-G**

Connection cable, M12 to M12, PUR cable, 4-pin

**Features**

- Improved resistance to weld slag
- Suitable for drag chains
- Suitable for robotic applications / torsion resistant
- Flame resistant cable
- Halogen-free
- Resistant to microbes and hydrolysis
- Free of paint coating substances
- Immunity to vibration, with mechanical latching
- Knurled nut suitable for tool assembly

**Technical data**

**General specifications**

Number of pins 4

**Electrical specifications**

Operating voltage  $U_B$  max. 250 V AC/DC  
 Operating current  $I_B$  max. 4 A  
 Volume resistance  $< 5 \text{ m}\Omega$

**Ambient conditions**

Ambient temperature Body: -40 ... 90 °C (-40 ... 194 °F)  
 cable, fixed: -40 ... 80 °C (-40 ... 176 °F)  
 cable, flexing: -25 ... 80 °C (-13 ... 176 °F)

Pollution Degree 3

**Mechanical specifications**

Contact elements spring-loaded contact socket

Pin diameter 1 mm

Degree of protection IP67

**Material**

Contacts CuSn / Au

Contact surface Au

Body TPU, black

Cable PUR

Slotted nut Diecast zinc

Sleeve connector Diecast zinc

Core insulation PP

Cable extra-fine wire, flexible

Sheath diameter  $\varnothing 4.3 \text{ mm}$

Bending radius  $> 10 \times$  cable diameter, moving  
 $> 5 \times$  cable diameter, fixed

Color black

Cores  $4 \times 0.34 \text{ mm}^2$

Conductor construction  $42 \times 0.1 \text{ mm } \varnothing$

Length L 3 m

**Drag chain suitability**

Drag chain cycles  $\geq 5000000$  (at max. 60 °C)

Motion velocity  $\leq 3.3 \text{ m/s}$

Traverse distance 5 m horizontal

Acceleration  $\leq 5 \text{ m/s}^2$

Torsion cycles  $\geq 1000000$  (at max. 60 °C)

Torsional stress  $\pm 180 \text{ }^\circ/\text{m}$

**Flammability**

Contact material 94 HB

Housing 94 V-2

Cable FT2

**Compliance with standards and directives**

**Electrical connection**

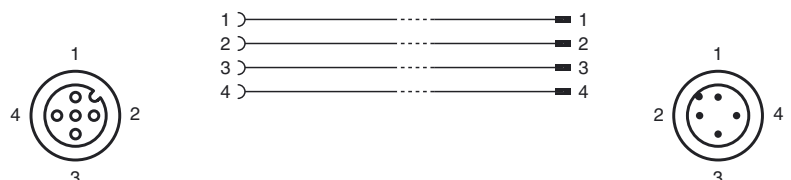

Release date: 2015-01-12 14:01 Date of issue: 2015-01-12 252983\_eng.xml

Standard conformity	
Degree of protection	EN 60529:2000
Standards	IEC 61076-2-101:2008
Flammability	Body: UL 94 Line: UL 1581 Section 1061; IEC 60332-1-2:2004
Halogen-free	IEC 60754-1:1994

Release date: 2015-01-12 14:01 Date of issue: 2015-01-12 252983\_eng.xml