



**Model Number**

**V15-W-S-YE2M-PUR-A-V15-G**

Connecting cable, M12 to M12, PUR cable 5-pin

**Features**

- Improved resistance to weld slag
- Appropriate for conveyor chains
- Suitable for robotic applications / torsion resistant
- Flame resistant cable
- Halogen-free
- Resistant to microbes and hydrolysis
- Free of paint coating substances
- Immunity to vibration, with mechanical latching
- Knurled nut suitable for tool assembly

**Dimensions**

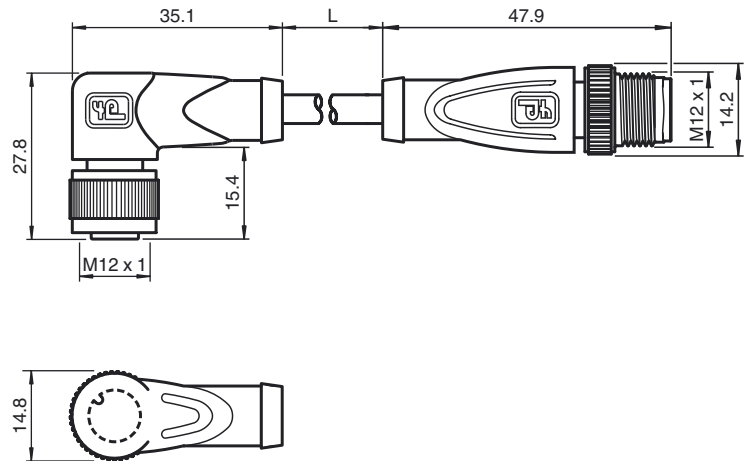

**Technical data**

**General specifications**

Number of pins	5
Connection 1	socket
Construction type 1	right angle
Threading 1	M12
Connection 2	Male connector
Construction type 2	straight
Threading 2	M12

**Electrical specifications**

Operating voltage	U <sub>B</sub>	max. 60 V AC/DC
Operating current		max. 4 A
Volume resistance		< 5 mΩ

**Ambient conditions**

Ambient temperature	Body: -40 ... 90 °C (-40 ... 194 °F) cable, fixed: -40 ... 80 °C (-40 ... 176 °F) cable, flexing: -25 ... 80 °C (-13 ... 176 °F)
Pollution Degree	3

**Mechanical specifications**

Contact elements	spring-loaded contact socket
Pin diameter	1 mm
Protection degree	IP67
Material	
Contacts	CuSn / Au
Contact surface	Au
Body	TPU, yellow
Cable	PUR
Slotted nut	Diecast zinc
Sleeve connector	Diecast zinc
Core insulation	PP
Cable	extra-fine wire, flexible
Sheath diameter	Ø 4.7 mm
Drag chain cycles	≥ 5000000 (at max. 60 °C)
Bending radius	> 10 x cable diameter, moving > 5 x cable diameter, fixed
Motion velocity	≤ 3.3 m/s
Traverse distance	5 m horizontal
Acceleration	≤ 5 m/s <sup>2</sup>
Torsion cycles	≥ 1000000 (at max. 60 °C)
Torsional stress	± 180 °/m
Color	yellow
Cores	5 x 0.34 mm <sup>2</sup>
Conductor construction	42 x 0.1 mm Ø
Length	L 2 m
Flammability	

**Electrical connection**

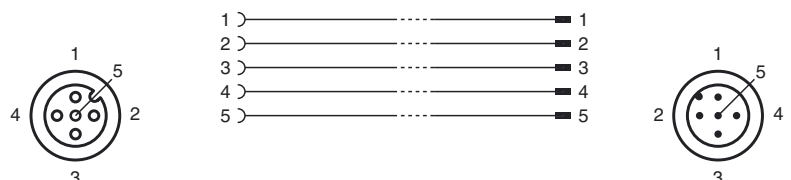

Release date: 2013-08-14 16:32 Date of issue: 2013-08-14 252998\_eng.xml



Contact material	94 HB
Housing	94 V-2
Cable	FT2

**Compliance with standards and directives**

Standard conformity	
Protection degree	EN 60529:2000
Standards	IEC 61076-2-101:2008
Flammability	Body: UL 94 Line: UL 1581 Section 1061; IEC 60332-1-2:2004
Halogen-free	IEC 60754-1:1994

Release date: 2013-08-14 16:32 Date of issue: 2013-08-14 252998\_eng.xml