



Model Number

AIR30/32-UP-2483/B

Active infrared scanner
Flush-mounted version

Features

- Single-beam light scanner
- Can be used to monitor both main and ancillary closing edges
- Closing edge safety on revolving doors and carousel doors
- Accurate beam alignment thanks to finely bundled light beam
- Flush-mounted version with front cover, black
- DC voltage version

Product information

AIR30 is a series of active infrared scanners with excellent optical properties for monitoring closing edges in a wide range of door systems. The diverse range of housings and mounting options allow the devices to be adapted to suit a whole host of mounting conditions.

Dimensions

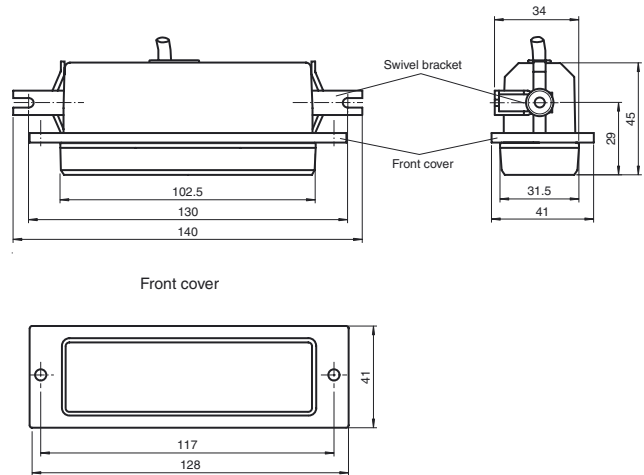

Electrical connection

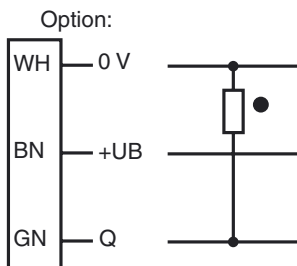

○ = Light on
● = Dark on

Indicators/operating means

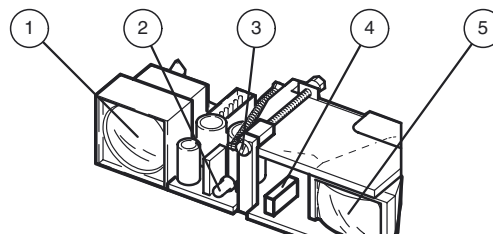

1	Transmitter
2	Indication-LED
3	Detection range adjuster
4	Light / Dark switch
5	Receiver

Release date: 2012-05-30 15:45 Date of issue: 2012-07-27 418018_eng.xml

Subject to modifications without notice

Pepperl+Fuchs Group
www.pepperl-fuchs.com

USA: +1 330 486 0001
fa-info@us.pepperl-fuchs.com

Germany: +49 621 776-4411
fa-info@pepperl-fuchs.com

Copyright Pepperl+Fuchs
Singapore: +65 6779 9091
fa-info@sg.pepperl-fuchs.com

Technical data

General specifications

Detection range min.	0 ... 1870 mm preset
Light source	IREL
Light type	modulated infrared light
Black/White difference (6%/90%)	≤ 400 mm at a distance of 2000 mm
Transmitter frequency	1800 Hz
Operating mode	Background evaluation
Diameter of the light spot	50 mm at 2000 mm sensor range
Angle of divergence	approx. 1.4 °
Accessories provided	Swivel bracket, Mounting bracket

Functional safety related parameters

MTTF _d	1050 a
Mission Time (T _M)	20 a
Diagnostic Coverage (DC)	90 %

Indicators/operating means

Function display	LED red: lights up when output is active
Controls	Detection range adjuster, light/dark switch
Factory setting	dark on

Electrical specifications

Operating voltage	U _B	10 ... 30 V DC
No-load supply current	I ₀	100 mA

Output

Switching type	light/dark on, switchable	
Signal output	1 PNP output, short-circuit protected, reverse polarity protected, open collector	
Switching voltage	30 V DC	
Switching current	≤ 200 mA	
Response time	50 ms	
De-energized delay	t _{off}	approx. 200 ms

Ambient conditions

Ambient temperature	-20 ... 70 °C (-4 ... 158 °F)
Storage temperature	-40 ... 70 °C (-40 ... 158 °F)

Mechanical specifications

Protection degree	IP52
Connection	2 m fixed cable
Material	
Housing	plastic
Optical face	Luran
Mass	40 g

Approvals and certificates

CE conformity	yes
CCC approval	Products with a maximum operating voltage of ≤36 V do not bear a CCC marking because they do not require approval.

Curves/Diagrams

Characteristic response curve

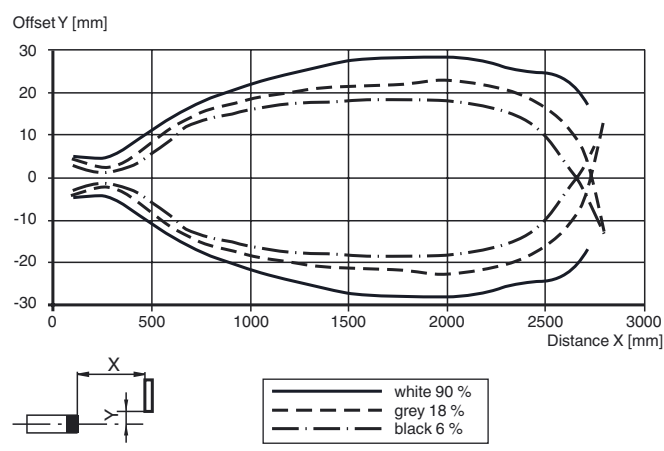

Typical applications

- Monitoring closing edges and crushing points on revolving doors and carousel doors
- Door monitoring system in local public transportation

Detection area

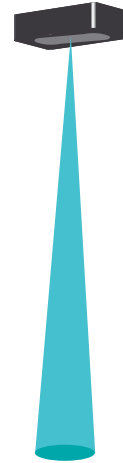

Accessories

UP-Einbaurahmen

Mounting frame for sensors in the AIR30 and PROSCAN series

Flush Mounting AIR30

Installation cover for AIR30 series sensors

Wetterhaube AIR30

Weather hood for series AIR30

Other suitable accessories can be found at www.pepperl-fuchs.com

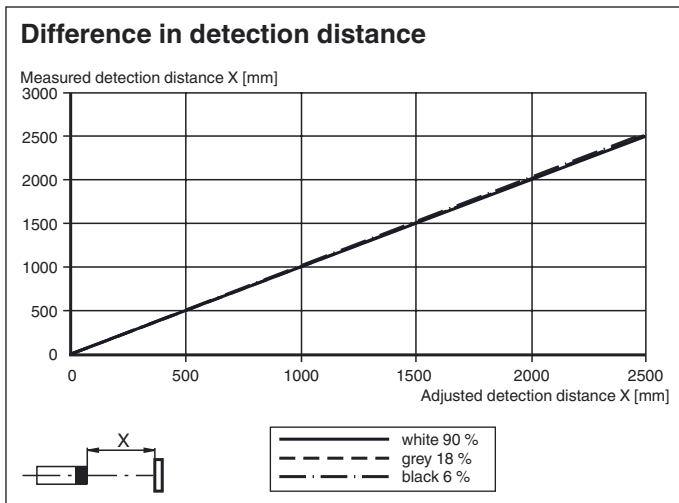
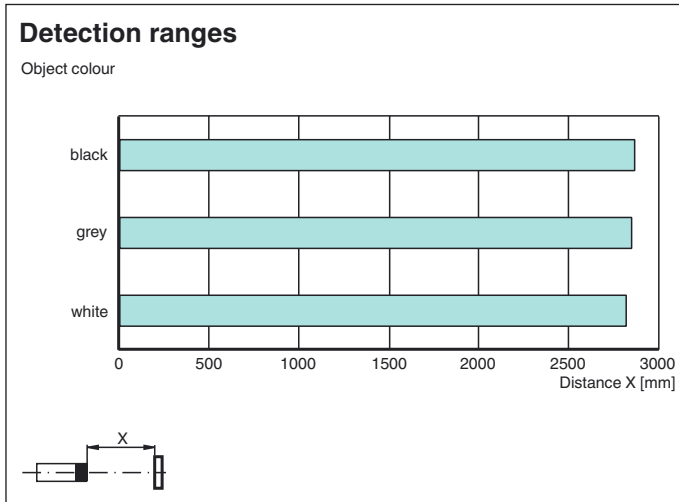

Operating principle

Active infrared scanners detect people and objects using short-wave infrared radiation according to the triangulation principle. A switch signal is tripped if the infrared beam emitted is reflected by an object within the specified sensing range. Where background evaluation is activated, the background (e.g. ground) is used as a reflector.

This allows reflective or shiny objects, such as vehicles and objects located close to the surface, to be detected reliably and in full.

Operating principle Background evaluation

Object in sensing field:

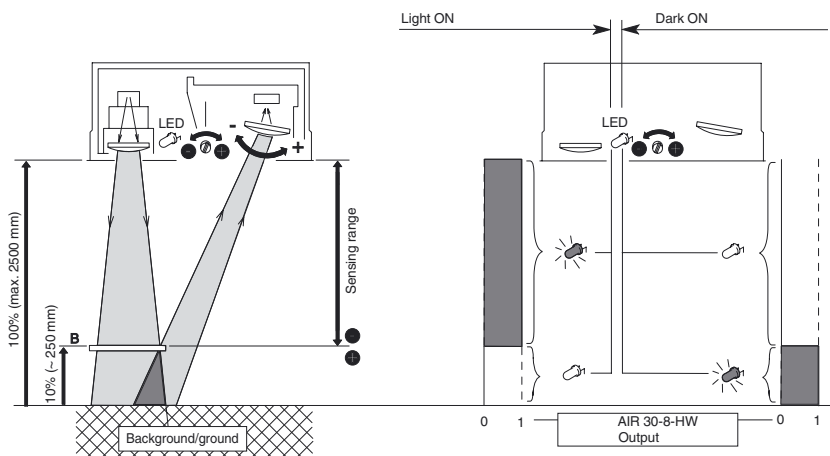

Release date: 2012-05-30 15:45 Date of issue: 2012-07-27 418018_eng.xml