

**Model Number**

**TOPSCAN2-8-HS-2500-3/L1350/38a**

Active infrared scanner  
Profile length 1350 mm

**Features**

- Moving presence sensor for swing doors
- Configurable for a wide range of door leaf widths
- Each beam can be adjusted individually
- Selectable background suppression and evaluation
- Beam adjustment to closing edge width
- Test input
- Three-beam version

**Product information**

The TopScan2 series is a modular sensor system that can be used in a flexible manner for various requirements relating to the monitoring of automatic doors. The system can be mounted for either static or mobile use. The housing can be easily shortened and up to five sensor modules can be arranged side by side, whereby each beam can be configured individually. When it comes to the operating modes, there is the choice between background suppression and background evaluation. The light or dark switching modes, detection range and closing edge alignment can also be adjusted. These features make the TopScan2 active infrared scanner ideal for use with a wide range of automatic door systems.

**Dimensions**

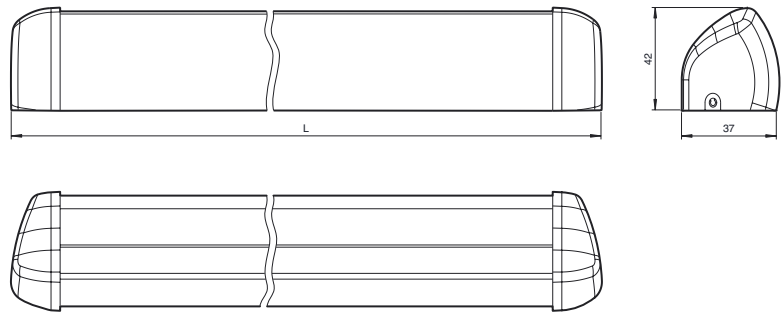

**Electrical connection**

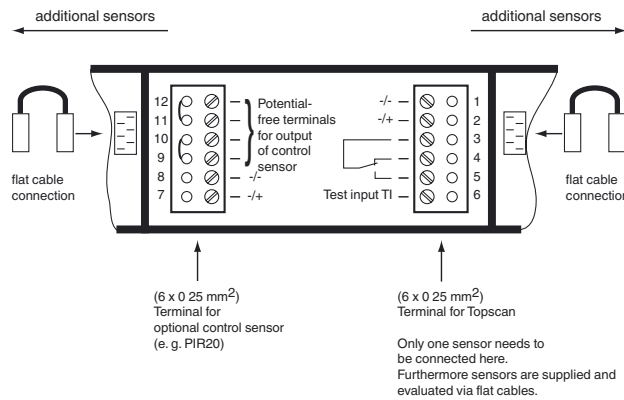

**Indicators/operating means**

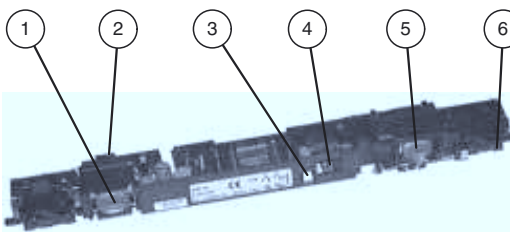

1	Transmitter
2	Adjuster for monitoring edge
3	Functional display
4	Programming switch
5	Receiver
6	Detection range adjuster

Release date: 2014-08-05 13:47 Date of issue: 2014-08-05 418042\_eng.xml

Refer to "General Notes Relating to Pepperl+Fuchs Product Information".

Pepperl+Fuchs Group  
www.pepperl-fuchs.com

USA: +1 330 486 0001  
fa-info@us.pepperl-fuchs.com

Germany: +49 621 776 4411  
fa-info@de.pepperl-fuchs.com

Singapore: +65 6779 9091  
fa-info@sg.pepperl-fuchs.com

## Technical data

### General specifications

Detection range min.	0 ... 1500 mm by background evaluation, 500 ... 1500 mm by background suppression
Detection range max.	0 ... 2500 mm with background evaluation, 500 ... 2500 mm with background suppression
Light source	IREL
Black/White difference (6%/90%)	< 20 % at 2000 mm sensor range
Marking	CE
Number of beams	3 (number of built-in sensor modules AIR)
Operating mode	switching between background suppression/evaluation
Diameter of the light spot	75 x 75 mm by sensing range 2000 mm

### Indicators/operating means

Function indicator	LED red
Control elements	Detection range adjuster, light/dark switch, changeover switch for mode of operation Background suppression / Background evaluation ; Adjuster for edge monitoring left/right
Factory setting	Background suppression

### Electrical specifications

Operating voltage	$U_B$	17 ... 30 V DC , 18 ... 28 V AC
No-load supply current	$I_0$	< 100 mA

### Input

Test input	emitter deactivation with $U = 17 \dots 30$ V DC only in background evaluation mode of operation and DC operation
------------	---

### Output

Switching type	Light/Dark switch
Signal output	Relay, 1 alternator
Switching voltage	max. 24 V DC , 48 V AC
Switching current	$\leq 1$ A
Switching power	24 W / 55 VA
Response time	30 ms , 2 s after test

### Ambient conditions

Ambient temperature	-20 ... 60 °C (-4 ... 140 °F)
---------------------	-------------------------------

### Mechanical specifications

Housing length L	1350 mm
Mounting height	max. 2500
Degree of protection	IP52
Connection	screw terminals
Material	
Housing	aluminum / ABS
Optical face	PC
Mass	approx. 650 g

### Compliance with standards and directives

Directive conformity	
EMC Directive 2004/108/EC	EN 61000-6-2:2005 EN 61000-6-3:2007
Standard conformity	
Standards	EN 62471:2008

### Approvals and certificates

CCC approval	CCC approval / marking not required for products rated $\leq 36$ V
UN/ECE Regulation No. 10 (E1)	Type-approval number: 047349

## Curves/Diagrams

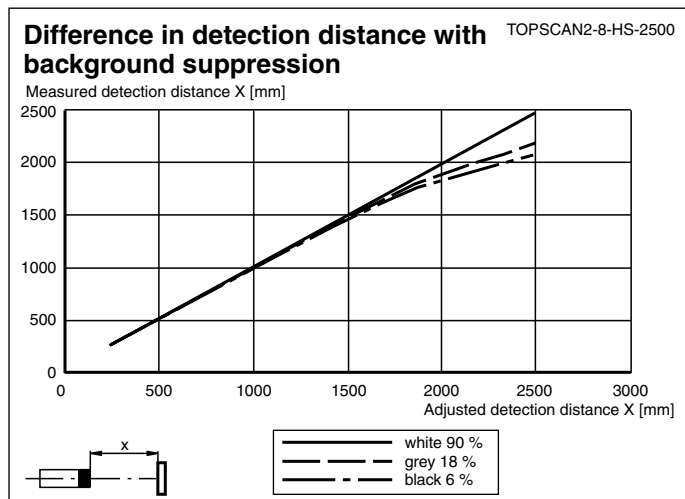

## Typical applications

- Protection mechanism for closing edges on automatic sliding doors and revolving doors
- Anti-collision protection for people/objects in the vicinity of revolving doors
- Edge and pinch protection for sliding doors
- Entry monitoring for buses and trains operated within the public transportation network

## Detection area

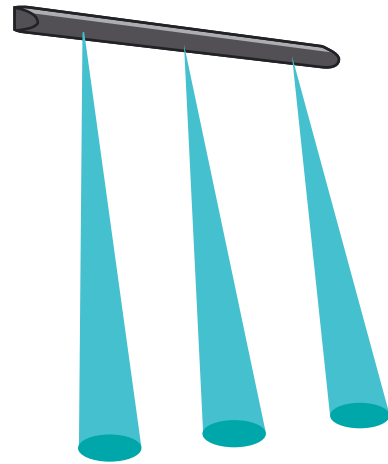

## Accessories

### AIR16

Sensor module

### LAGERBOCK AIR16

Pedestal for the sensor module AIR16

### Topscan Cable Loop Basic

Metal cable protector

### TopScan2 Cable 300 mm

Ribbon cable for connecting sensor modules

### TopScan-S Cap Set

End cover for TopScan-S aluminum profile section

### TopScan-S Gasket IP54

Housing seal TopScan-S

### TopScan-S Profile L1400

Housing profile TopScan-S

### Topscan2 Cover L1400

TopScan2 housing cover

### DoorScan Weather Cap L1200

All-weather hood for DoorScan® and TopScan series sensing strips

Other suitable accessories can be found at [www.pepperl-fuchs.com](http://www.pepperl-fuchs.com)

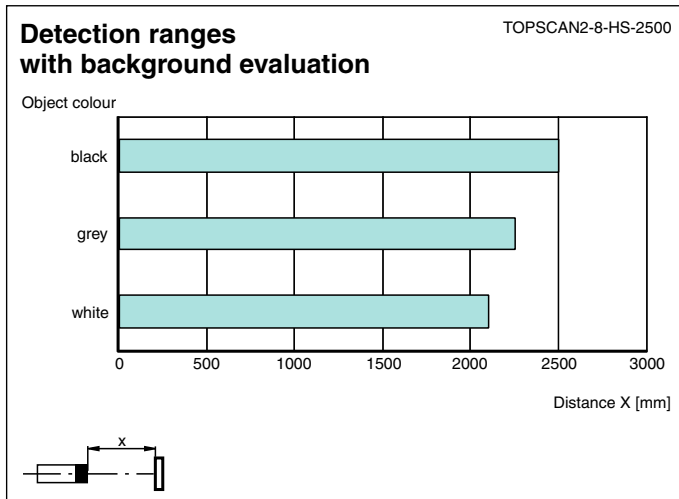
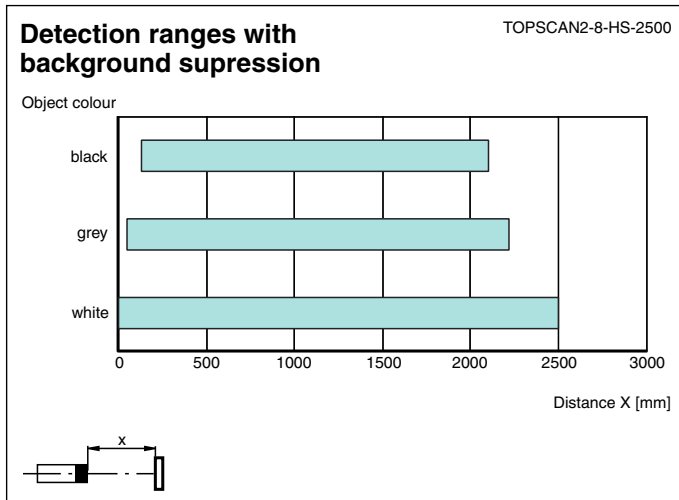
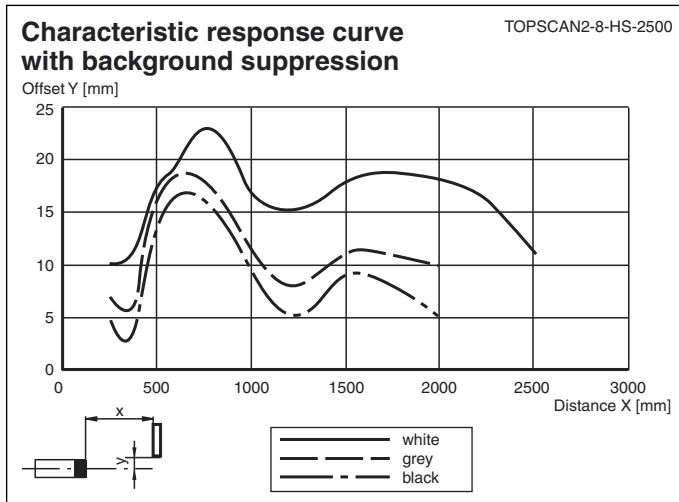

## Operating principle

The two large-area lenses (one for the infrared transmitter and one for the two photodiode receivers with ambient light filter) have an optical center-to-center distance of approx. 150 mm, resulting in a light spot size of 75 mm x 75 mm. The angle of the two lens systems can be adjusted to each other via a precision gear according to the principle of background/foreground suppression. Such precisely defined focal lengths enable a precision detection range setting of up to 2500 mm.

The detection range can be extended up to 2500 mm and responds to any object in the detection area, with minimal effect from the surface color and structure. Reflection levels that exceed the specified maximum detection range are not detected by the sensor, even with highly reflective objects — for example corrugated aluminum plates or marble floors (with background suppression). The detection fields of several devices can be overlapped without interference.

### Background Suppression Operating Mode

In this operating mode, the background is "detected" but not actually evaluated (ignored). A reflection signal from an object within the specified detection area is required as a switching signal.

### Background Evaluation Operating Mode

The TopScan2 can also be used with a test option, regardless of whether or not there is an object/person in the detection area. The receiver con-

stantly sees the reflected light from the transmitter when the background is present. Testing is performed by disconnecting the transmitter from the supply voltage.

The background is used as a reflector. If the light beam is broken by an object, a switching signal is triggered.

## Configuration information

### Configuring the Monitoring Edge

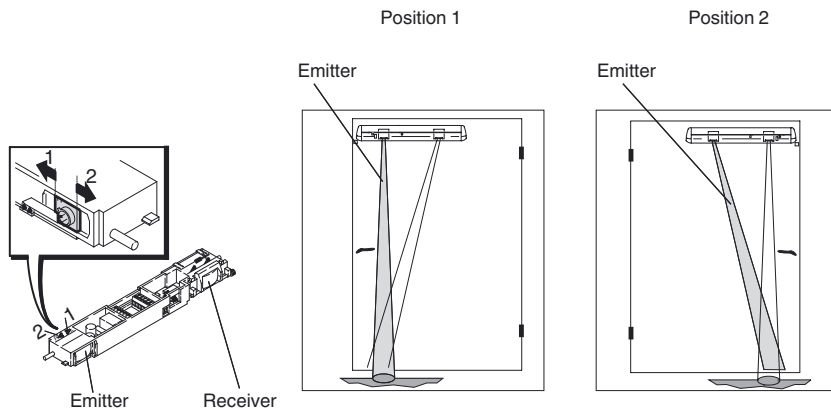

The transmitter of each sensor features two beam position settings via which the monitoring edge can be aligned to the left or to the right.

### Detection range setting:

1. Rotate the adjustment screw counter-clockwise until the LED illuminates
2. Slowly rotate the adjustment screw clockwise until the LED goes out
3. Then rotate the adjustment screw further by 1/8 of a rotation

↶ shorter

↷ longer

switch approx. 15 cm ... 20 cm  
above ground

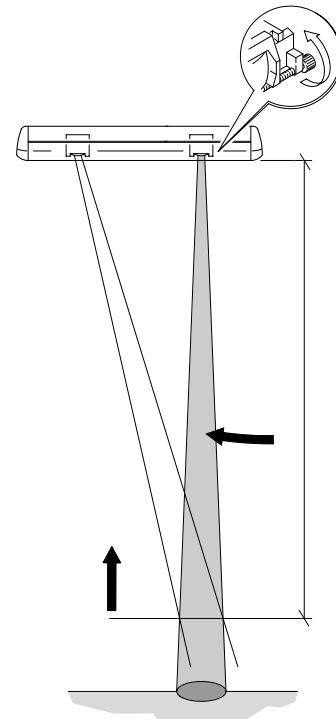

### Angle settings:

By rotating the sensor around its rotational axis (1), the offset (2) of the detection point to the wall can be easily changed. The angle setting can be continuously adjusted from 0° to 30°.

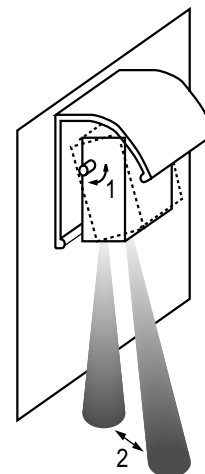

**Programming:**

Both the switching mode and the operating mode can be configured via the programming switch for each sensor.

Test input (TE) — background suppression operating mode

TE	Switching mode	LED	Signal output
Active	Light	Does not illuminate	Closed
Active	Dark	Does not illuminate	Open

Note: only if there is an object in the detection area

Test input (TE) — background evaluation operating mode

TE	Switching mode	LED	Signal output
Active	Light	Illuminates	Open
Active	Dark	Illuminates	Closed

Note: Regardless of whether or not there is an object in the detection area

**Light On Switching Mode (H)**

A light scanner's output is switched on (activated) if the receiver detects "light", i.e. there is an object in the operating range.

**Dark On Switching Mode (D)**

A light scanner's output is switched on (activated) if the receiver detects "dark", i.e. there is no object in the operating range.

Programming switch

	Left	Right
<b>Open</b>	Background suppression	Dark on
<b>Closed</b>	Background evaluation	Light on