

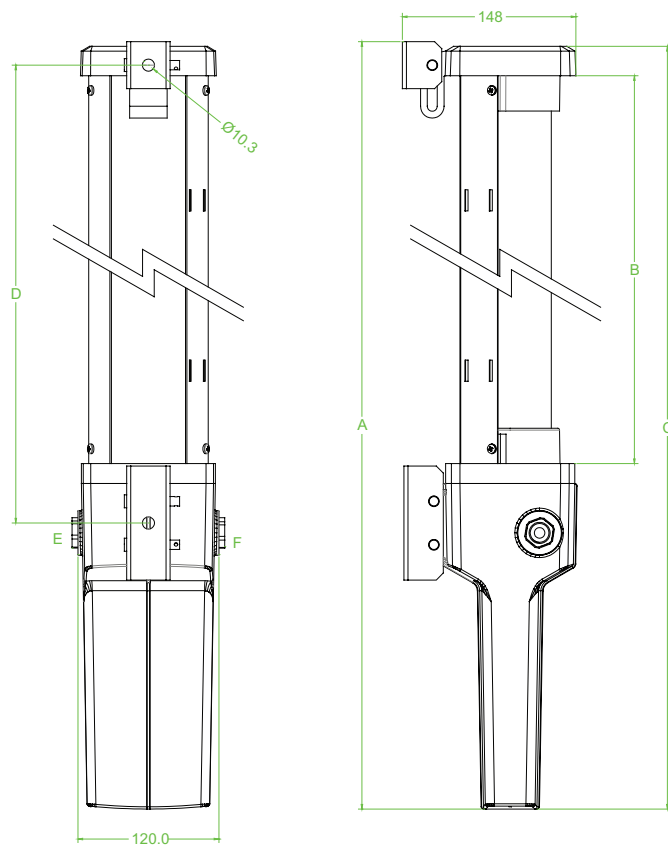

### Features

- Power 58 W
- Installation in Zone 1, Zone 2, Zone 21 and Zone 22
- Ex d certified
- Multi voltage electronic ballast
- AC or DC
- Borosilicate glass overtube resistant to process chemicals
- Sturdy metallic housing

### Dimensions (mm)



### Technical data

#### Electrical specifications

Operating voltage	198 ... 264 V 50/60 Hz 176 ... 280 V DC
Operating current	0.24 A
Terminal capacity	2.5 mm <sup>2</sup> Connection block suitable for through wiring
Control gear	high frequency electronic ballast complying with all European standards relating to safety, operation and EMC (Immunity)
Power factor	0.98
Fitting type	Ceiling light fitting
Lamps	T8 bi-pin fluorescent tube , not included with delivery
Number of lamps	1
Length	1500 mm ( 5 ft )
Power	58 W
EMC in accordance with	EN55015:2000
<b>Conformity</b>	
Protection degree	EN 60529
<b>Ambient conditions</b>	
Ambient temperature	-20 ... 40 °C (-4 ... 104 °F) / T6 / T85°C -20 ... 55 °C (-4 ... 131 °F) / T5 / T100°C -20 ... 60 °C (-4 ... 140 °F) / T4 / T135°C
<b>Mechanical specifications</b>	
Cover fixing	M8 stainless steel socket cap head screws
Protection degree	IP67 according to EN 60529
Cable entry	metric threaded
Number of cable entries	1 x M20 at position E fitted with Ex d sealing plug 1 x M20 at position F fitted with Ex d sealing plug
<b>Material</b>	

Cast parts	Light metal alloy
Lamp cover	Borosilicate glass
Reflector	0.9 mm galvanised mild steel
Finish	cast parts: epoxy powder coated, RAL7032 reflector: epoxy powder coated, white
Seal	nitrile O-ring
Mass	approx. 8 kg
Dimensions	
A	1820 mm
B	1497 mm
C	1816 mm
D	1557 mm
Mounting	2 x stainless steel removable mounting brackets
Grounding	Internal connection
<b>Data for application in connection with Ex-areas</b>	
EC-Type Examination Certificate	SIRA 00 ATEX 1107X
Group, category, type of protection, temperature class	⊕ II 2 GD Ex d IIC T* Gb, Ex tb IIIC T** °C Db
<b>International approvals</b>	
IECEX approval	IECEX SIR 10.0077X
GOST-R approval	GOST-R B01007
<b>General information</b>	
Supplementary information	EC-Type Examination Certificate, Statement of Conformity, Declaration of Conformity, Attestation of Conformity and instructions have to be observed where applicable. For information see <a href="http://www.pepperl-fuchs.com">www.pepperl-fuchs.com</a> .