

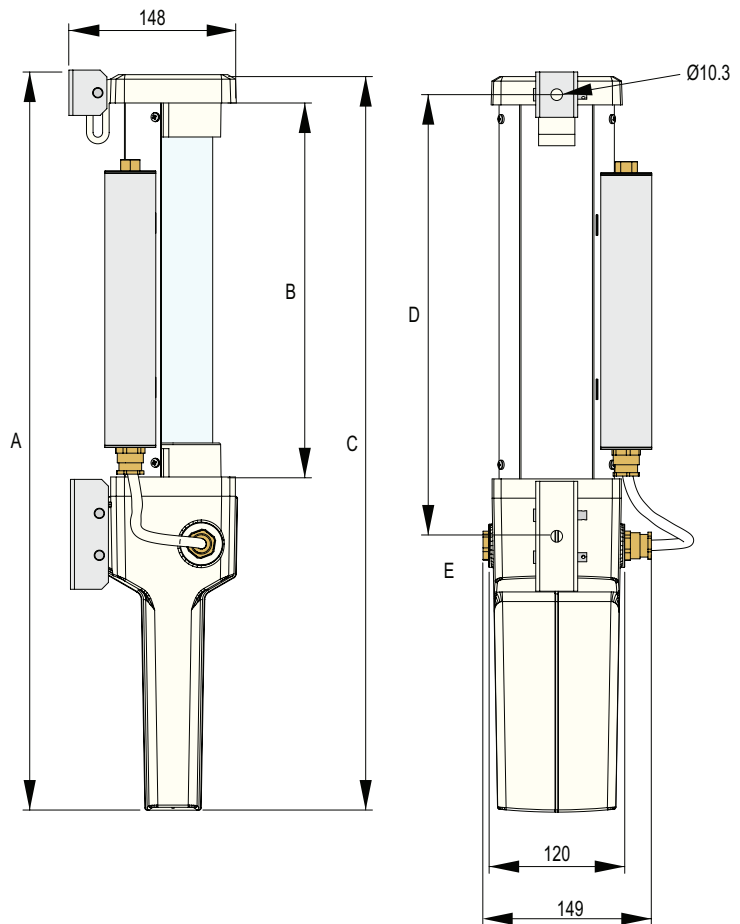

Features

- Power 58 W
- Installation in Zone 1, Zone 2, Zone 21 and Zone 22
- Ex de certified
- Multi voltage electronic ballast
- AC model
- Borosilicate glass overtube resistant to process chemicals
- Sturdy metallic housing

Dimensions (mm)



Technical data

Electrical specifications

Operating voltage	207 ... 254 V 50/60 Hz
Operating current	0.28 A
Terminal capacity	2.5 mm ²
Control gear	high frequency electronic ballast complying with all European standards relating to safety, operation and EMC (Immunity)
Power factor	0.98
Fitting type	Ceiling light fitting
Lamps	T8 bi-pin fluorescent tube , not included with delivery
Number of lamps	1
Length	1500 mm (5 ft)
Power	58 W
EMC in accordance with	EN55015:2000
Emergency operation	maintained or non-maintained
Operation time	3 h
Recharge time	24 h from fully discharged
Ballast lumen factor	7 %
Battery protection	Protection against deep discharge and reverse battery polarity

Conformity

Protection degree EN 60529

Ambient conditions

Ambient temperature -20 ... 40 °C (-4 ... 104 °F) / T6 / T85°C
-20 ... 50 °C (-4 ... 122 °F) / T5 / T100°C

Mechanical specifications

Cover fixing	M8 stainless steel socket cap head screws
Protection degree	IP67 according to EN 60529
Cable entry	metric threaded
Number of cable entries	1 x M20 at position E fitted with Ex d sealing plug

Material	
Cast parts	Light metal alloy
Lamp cover	Borosilicate glass
Reflector	0.9 mm galvanised mild steel
Finish	cast parts: epoxy powder coated, RAL7032 reflector: epoxy powder coated, white
Seal	nitrile O-ring
Mass	approx. 9.5 kg
Dimensions	
A	1820 mm
B	1497 mm
C	1816 mm
D	1557 mm
Mounting	2 x stainless steel removable mounting brackets
Grounding	Internal connection
Data for application in connection with Ex-areas	
EC-Type Examination Certificate	SIRA 00 ATEX 1107X
Group, category, type of protection, temperature class	⊕ II 2 GD Ex de IIB T* Gb, Ex tb IIIC T** °C Db
International approvals	
IECEX approval	IECEX SIR 10.0077X
GOST-R approval	GOST-R B01007
General information	
Supplementary information	EC-Type Examination Certificate, Statement of Conformity, Declaration of Conformity, Attestation of Conformity and instructions have to be observed where applicable. For information see www.pepperl-fuchs.com .