

### Features

- Power 18 W
- Installation in Zone 1, Zone 2, Zone 21 and Zone 22
- Ex de certified
- Multi voltage electronic ballast
- AC model
- Borosilicate glass overtube resistant to process chemicals
- Sturdy metallic housing

### Dimensions (mm)

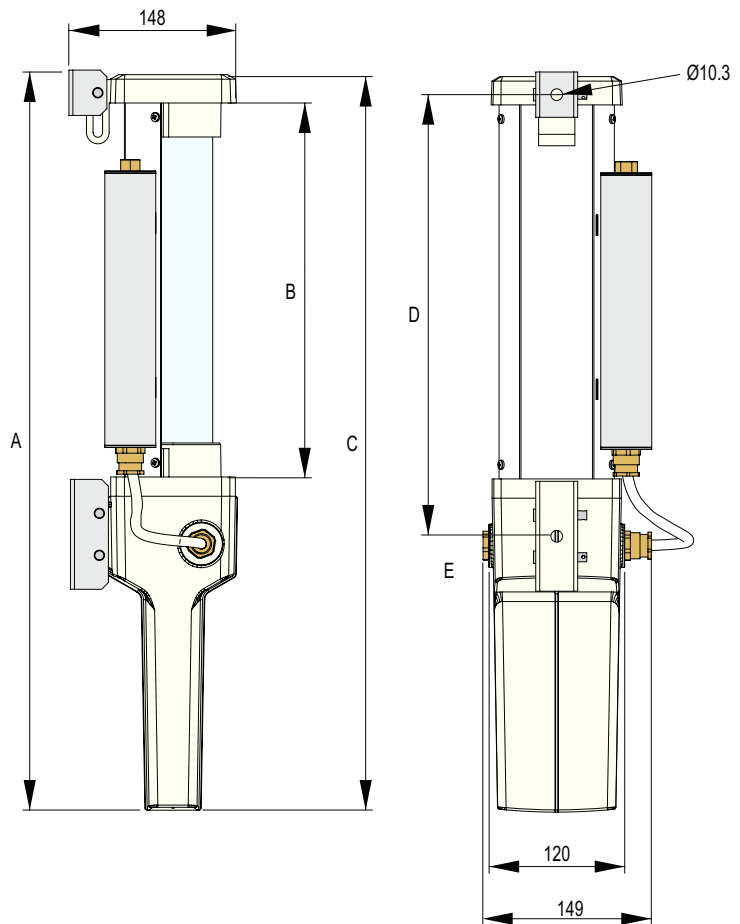

### Technical data

#### Electrical specifications

Operating voltage	207 ... 254 V 50/60 Hz
Operating current	0.12 A
Terminal capacity	2.5 mm <sup>2</sup>
Control gear	high frequency electronic ballast complying with all European standards relating to safety, operation and EMC (Immunity)
Power factor	0.98
Fitting type	Ceiling light fitting
Lamps	T8 bi-pin fluorescent tube , not included with delivery
Number of lamps	1
Length	600 mm ( 2 ft )
Power	18 W
EMC in accordance with	EN55015:2000
Emergency operation	maintained or non-maintained
Operation time	3 h
Recharge time	24 h from fully discharged
Ballast lumen factor	12 %
Battery protection	Protection against deep discharge and reverse battery polarity

#### Conformity

Protection degree EN 60529

#### Ambient conditions

Ambient temperature -20 ... 40 °C (-4 ... 104 °F) / T6 / T85°C  
-20 ... 50 °C (-4 ... 122 °F) / T5 / T100°C

#### Mechanical specifications

Cover fixing	M8 stainless steel socket cap head screws
Protection degree	IP67 according to EN 60529
Cable entry	metric threaded
Number of cable entries	1 x M20 at position E fitted with Ex d sealing plug

<b>Material</b>	
Cast parts	Light metal alloy
Lamp cover	Borosilicate glass
Reflector	0.9 mm galvanised mild steel
Finish	cast parts: epoxy powder coated, RAL7032 reflector: epoxy powder coated, white
Seal	nitrile O-ring
Mass	approx. 6.5 kg
<b>Dimensions</b>	
A	915 mm
B	592 mm
C	911 mm
D	652 mm
Mounting	2 x stainless steel removable mounting brackets
Grounding	Internal connection
<b>Data for application in connection with Ex-areas</b>	
EC-Type Examination Certificate	SIRA 00 ATEX 1107X
Group, category, type of protection, temperature class	⊕ II 2 GD Ex de IIC T* Gb, Ex tb IIIC T** °C Db
<b>International approvals</b>	
IECEX approval	IECEX SIR 10.0077X
GOST-R approval	GOST-R B01007
<b>General information</b>	
Supplementary information	EC-Type Examination Certificate, Statement of Conformity, Declaration of Conformity, Attestation of Conformity and instructions have to be observed where applicable. For information see <a href="http://www.pepperl-fuchs.com">www.pepperl-fuchs.com</a> .