

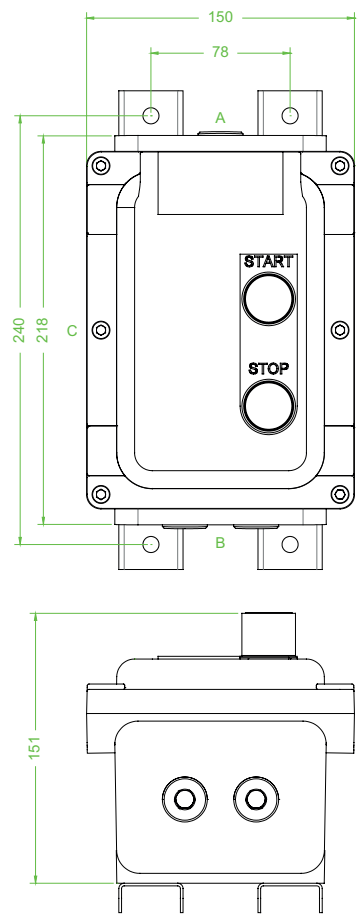

Features

- Coil voltage 415V
- Cast Iron
- 218 mm x 150 mm x 151 mm
- Suitable for Ex e motors
- Installation in Zone 1, Zone 2, Zone 21 and Zone 22

Dimensions (mm)



Technical data

Electrical specifications

Contactor rating	
Power	5.5 kW
Current	12 A (AC3)
Coil Voltage	415 V
Terminal capacity	2x 1-6mm ² for solid cable 2x 1-4mm ² for flexible cable with ferrule
Overload relay	9 ... 12 A
Phases	3
Function	direct online starter

Mechanical specifications

Height	218 mm
Width	150 mm
Depth	151 mm
Cover fixing	M6 stainless steel socket cap head screws
Protection degree	IP65
Cable entry	metric threaded
Number of cable entries	1 x M20 in face A 2 x M20 in face B all entries are fitted with Ex d sealing plugs

Material

Enclosure	cast iron
Finish	painted black
Seal	by grease
Mass	approx. 11 kg
Mounting	2 x fabricated stainless steel mounting straps
Grounding	internal & external brass grounding terminals on base and lid

Ambient conditions

Ambient temperature	-40 ... 55 °C (-40 ... 131 °F)
Data for application in connection with Ex-areas	
EC-Type Examination Certificate	SIRA 02 ATEX 1332
Group, category, type of protection, temperature class	⊕ II 2 GD Ex d IIB T6 Gb, Ex tb IIIC T85°C Db
International approvals	
IECEX approval	IECEX SIR 08.0066X
GOST-R approval	GOST-R B01008
Conformity	
Protection degree	EN 60529
General information	
Supplementary information	EC-Type Examination Certificate, Statement of Conformity, Declaration of Conformity, Attestation of Conformity and instructions have to be observed where applicable. For information see www.pepperl-fuchs.com .

Electrical Specification

