



Model Number

V1-G-YE5M-PVC-U-V1-W

Connecting cable, M12 to M12, PVC cable 4-pin

Features

- UL Recognized Component
- Knurled nut suitable for tool assembly
- Immunity to vibration, with mechanical latching
- Gold-plated and machined contacts
- Protection degree IP67 / IP68 / IP69K

Dimensions

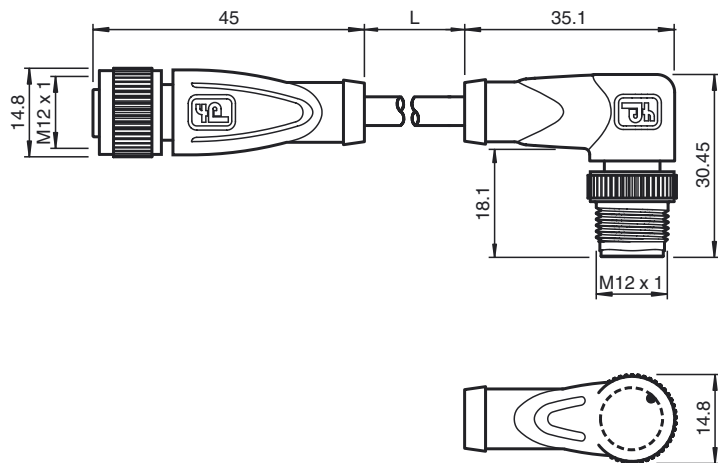

Technical data

General specifications

Number of pins	4
Connection 1	socket
Construction type 1	straight
Threading 1	M12
Connection 2	Male connector
Construction type 2	straight
Threading 2	M12
UL File Number	E231213

Electrical specifications

Operating voltage	U _B	max. 250 V AC/DC
Operating current		max. 4 A
Volume resistance		< 5 mΩ

Ambient conditions

Ambient temperature	Body: -40 ... 90 °C (-40 ... 194 °F) cable, flexing: -25 ... 80 °C (-13 ... 176 °F) cable, fixed: -5 ... 80 °C (23 ... 176 °F)
Pollution Degree	3

Mechanical specifications

Contact elements	spring-loaded contact socket
Pin diameter	1 mm
Protection degree	IP67 / IP68 / IP69k
Material	
Contacts	CuSn / Au
Contact surface	Au
Body	TPU, black
Cable	PVC
Slotted nut	Diecast zinc
Sleeve connector	Diecast zinc
Core insulation	PVC
Cable	fine-strand, flexible
Sheath diameter	Ø 4.3 mm
Bending radius	> 15 x cable diameter, induced > 5 x cable diameter, fixed
Color	yellow
Cores	4 x 0.34 mm ²
Conductor construction	19 x 0.15 mm Ø
Length	L 5 m
Flammability	
Contact material	HB
Housing	V-2
Cable	FT1

Compliance with standards and directives

Electrical connection



Release date: 2013-08-14 13:14 Date of issue: 2013-08-14 456585_eng.xml

Refer to "General Notes Relating to Pepperl+Fuchs Product Information".

Pepperl+Fuchs Group
www.pepperl-fuchs.com

USA: +1 330 486 0001
fa-info@us.pepperl-fuchs.com

Germany: +49 621 776 4411
fa-info@de.pepperl-fuchs.com

Singapore: +65 6779 9091
fa-info@sg.pepperl-fuchs.com

Standard conformity	
Protection degree	EN 60529:2000
Standards	IEC 61076-2-101:2008
Flammability	Body: UL 94 Line: UL 1581 Section 1061; IEC 60332-1-2:2004
Approvals and certificates	
UL approval	cURus AWM 2095 AWM I/II A/B 80°C 300V FT1 (cable)

Release date: 2013-08-14 13:14 Date of issue: 2013-08-14 456585_eng.xml