



Model Number

VMB-2+P/Z2-2M-PUR-V1-G

Valve connector, Form B, 2+PE, Z-diode, PUR cable to M12 round plug connector

Features

- Valve connector according EN 175301-803 A/ISO 4400 (previously DIN 43650)
- Z diode as a protective circuit
- Built-in LED, as operating and function indicator
- Moulded seal
- Flame resistant cable
- Halogen-free

Dimensions

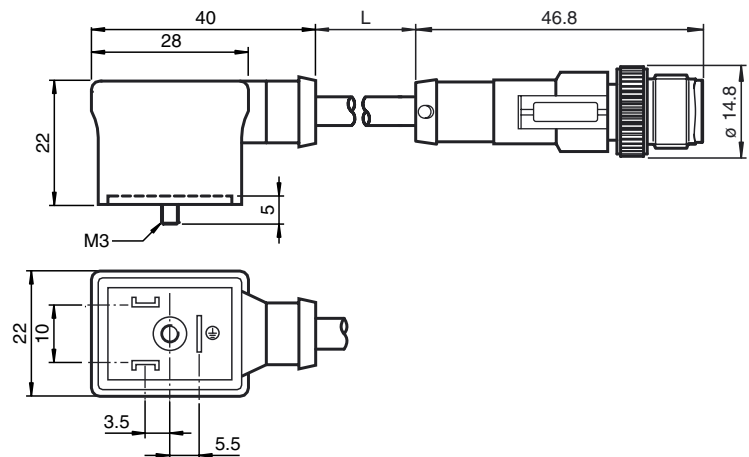

Technical data

General specifications

Number of pins	2 + PE
Connection 1	Valve connector DIN
Construction type 1	right angle
Connection 2	Male connector
Construction type 2	straight
Threading 2	M12

Indicators/operating means

LED yellow	Functional display
------------	--------------------

Electrical specifications

Operating voltage	U_B	24 V AC/DC
Operating current		max. 4 A
Volume resistance		< 5 m Ω

Ambient conditions

Ambient temperature	Body: -20 ... 85 °C (-4 ... 185 °F) cable, flexing: -20 ... 80 °C (-4 ... 176 °F) cable, fixed: -40 ... 80 °C (-40 ... 176 °F)
---------------------	--

Pollution Degree	3
------------------	---

Mechanical specifications

Degree of protection	IP65/IP67
Connection	Valve connector Form B
Material	
Contacts	CuSn
Contact surface	Sn
Body	TPU, black
Cable	PUR
Core insulation	PP
Cable	
Sheath diameter	\varnothing 4.5 mm
Bending radius	> 50 mm > 22.5 mm, fixed
Color	black
Cores	(2 + 1) x 0.5 mm ² ; 20 AWG
Conductor construction	28 x 0.15 mm \varnothing
Length	L 2 m

Electrical connection

