



Model Number

M100/MV100-6091/102

Thru-beam sensor
with 2 m fixed cable

Features

- Miniature design
- Slit aperture to shape the light in miniature sensors
- Easy to use
- Very bright, highly visible light spot
- Full metal thread mounting
- Highly visible LEDs for Power ON and switching state
- Not sensitive to ambient light

Product information

The ML100 series is characterized by its miniature housing with integral, all-metal threaded bushings. All versions are equipped with a visible red transmitter LED. This greatly simplifies installation and commissioning. The switching states are easily visible from all directions thanks to the highly visible LEDs.

Release date: 2014-07-10 16:05 Date of issue: 2014-07-10 813891_eng.xml

Dimensions

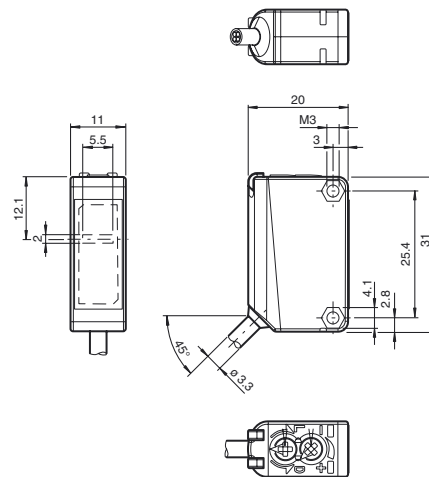

Electrical connection

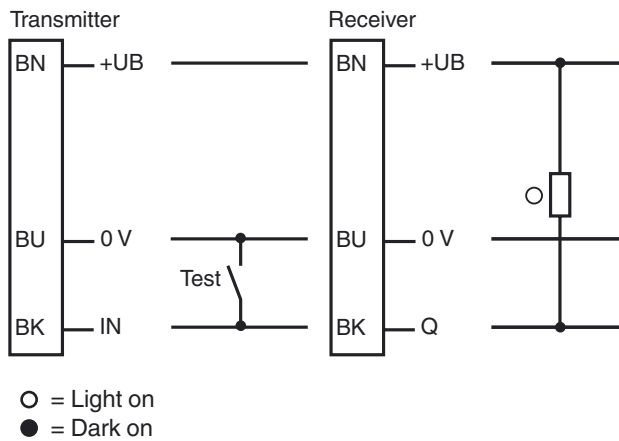

Indicators/operating means

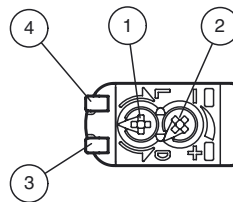

1	Light-Dark-switching	
2	Sensitivity adjuster	
3	Signal display	yellow
4	Operating display	green

Technical data**System components**

Emitter	M100-6091/76b
Receiver	MV100-6091/102

General specifications

Effective detection range	0 ... 2.8 m
Threshold detection range	4 m
Light source	LED
Light type	modulated visible red light
Diameter of the light spot	approx. 0.3 m at a distance of 4 m
Angle of divergence	approx. 2 °
Optical face	frontal
Ambient light limit	EN 60947-5-2

Functional safety related parameters

MTTF _d	860 a
Mission Time (T _M)	20 a
Diagnostic Coverage (DC)	0 %

Indicators/operating means

Operation indicator	LED green: power on
Function indicator	Receiver: LED yellow, lights up when light beam is free, flashes when falling short of the stability control ; OFF when light beam is interrupted
Control elements	sensitivity adjustment
Control elements	Light/Dark switch

Electrical specifications

Operating voltage	U _B	10 ... 30 V DC , class 2
Ripple		max. 10 %
No-load supply current	I ₀	Emitter: ≤ 15 mA Receiver: ≤ 8 mA

Input

Test input	emitter deactivation at 0 V
------------	-----------------------------

Output

Switching type	light/dark on, switchable	
Signal output	1 NPN output, short-circuit protected, reverse polarity protected, open collector	
Switching voltage	max. 30 V DC	
Switching current	max. 100 mA , resistive load	
Voltage drop	U _d	≤ 1.5 V DC
Switching frequency	f	1000 Hz
Response time		0.5 ms

Ambient conditions

Ambient temperature	-30 ... 60 °C (-22 ... 140 °F)
Storage temperature	-40 ... 70 °C (-40 ... 158 °F)

Mechanical specifications

Degree of protection	IP67
Connection	2 m fixed cable
Material	
Housing	PC (Polycarbonate)
Optical face	PMMA
Mass	approx. 100 g (emitter and receiver)
Cable length	2 m

Compliance with standards and directives

Directive conformity	
EMC Directive 2004/108/EC	EN 60947-5-2
Standard conformity	
Standards	UL 508

Approvals and certificates

UL approval	cULus Listed, Class 2 Power Source, Type 1 enclosure
CCC approval	CCC approval / marking not required for products rated ≤36 V
Approvals	CE, cULus Listed 57M3 (Only in association with UL Class 2 power supply; Type 1 enclosure)

Accessories

OMH-ML100-01
Mounting bracket

OMH-ML100-02
Mounting bracket

OMH-ML100-03
Mounting aid for round steel ø 12 mm or sheet 1.5 mm ... 3 mm

OMH-ML100-04
Mounting bracket

OMH-ML100-05
Mounting bracket

OMH-F10-ML100
Mounting aid for ML100 series

OMH-10
Mounting aid

OMH-ML100-S1
Mounting bracket

OMH-ML100-08
Mounting aid

Other suitable accessories can be found at www.pepperl-fuchs.com

Curves/Diagrams

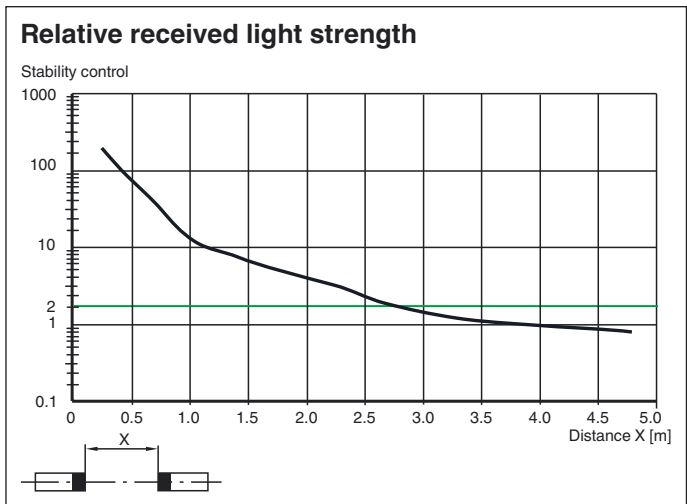
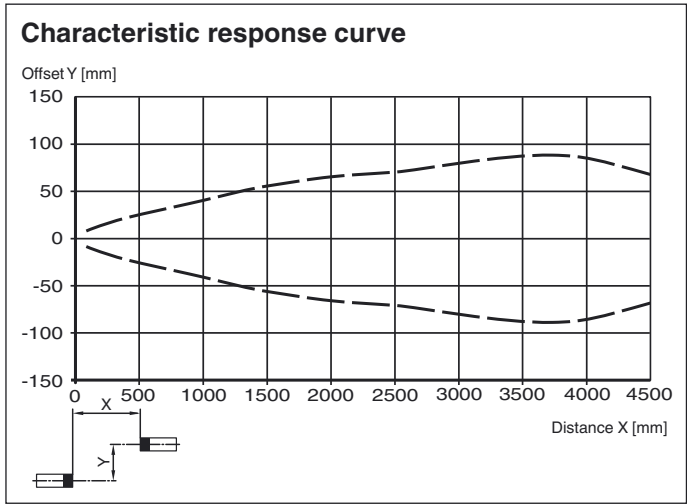

Release date: 2014-07-10 16:05 Date of issue: 2014-07-10 813891_eng.xml

Refer to "General Notes Relating to Pepperl+Fuchs Product Information".

Pepperl+Fuchs Group
www.pepperl-fuchs.com

USA: +1 330 486 0001
fa-info@us.pepperl-fuchs.com

Germany: +49 621 776 4411
fa-info@de.pepperl-fuchs.com

Singapore: +65 6779 9091
fa-info@sg.pepperl-fuchs.com