

Dimensions

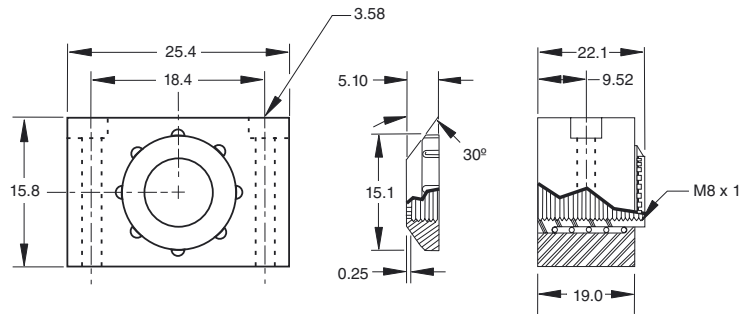

Technical data

Mechanical specifications

Material	Housing: anodized aluminum Protective cap: plastic
----------	---

Model Number

BCM-08

Mounting Block

Features

- Block cushion mount
- For 8 mm diameter sensors
- Maximum overtravel 8.89 mm

Application

The spring loaded block cushion mount provides surface-mountable protection against accidental target contact for standard shielded inductive sensors.