



Model Number

IVH-FP4

System IV read/write head

Features

- Connection via terminal compartment
- Dual-LED for function display
- Degree of protection IP67

Dimensions

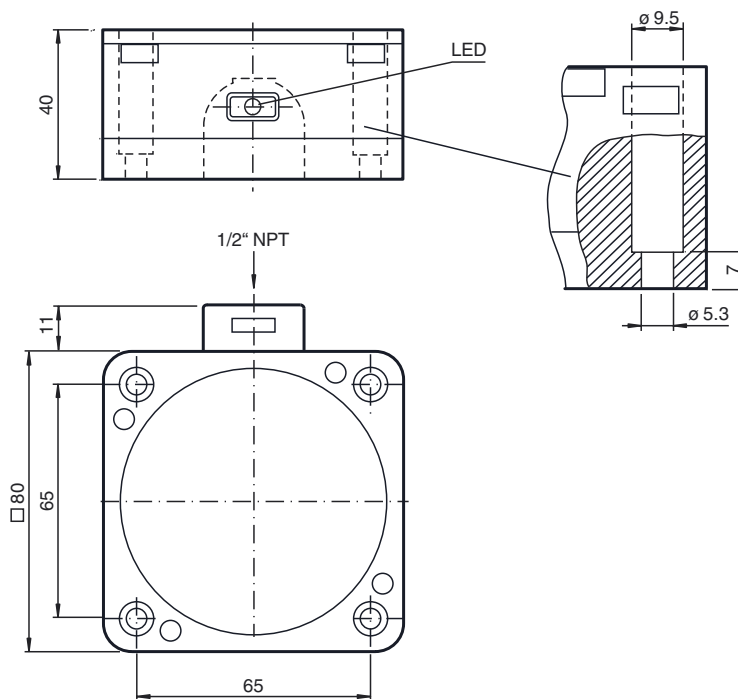

Electrical connection

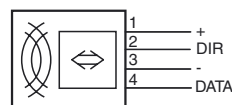

Technical data

General specifications

Operating frequency	250 kHz
Transfer rate	7.8 kBit/s
Operating distance	maximum: 100 mm

Indicators/operating means

LED green/yellow	green: Power on yellow: Data carrier detected
------------------	--

Electrical specifications

Power consumption	P_0	1.3 W
-------------------	-------	-------

Ambient conditions

Ambient temperature	-25 ... 70 °C (-13 ... 158 °F)
Storage temperature	-40 ... 85 °C (-40 ... 185 °F)

Mechanical specifications

Degree of protection	IP67 according to EN 60529
Connection	terminal compartment, $\leq 2.5 \text{ mm}^2$ conductor csa
Material	
Housing	PBT
Base	diecast aluminum
Installation	
In metal	non-flush, overshoot at least 10 mm
Distance between two heads	$\geq 500 \text{ mm}$