



Semi-flush-mount Room Thermostats with LCD **RDF510.2**

for 2-pipe fan coil units; for use with compressors in DX type equipment

- Output for on/off valve actuator, 3-wire on/off valve actuator or 1-stage compressor
- 3-speed fan control: Automatic or manual
- Manual heating/cooling changeover or continuous Cooling only or Heating only
- Operating modes: Comfort, Protection
- Adjustable commissioning and control parameters
- Optional display of room temperature or setpoint
- Minimum and maximum setpoint limitation
- Display temperature in increments of 0.5 °C or 1 °F
- Operating voltage: AC 230 V
- Mounting on recessed rectangular conduit box with fixing centre 60.3 mm

Use

For controlling the room temperature in individual rooms and zones that are:

- heated or cooled with 2-pipe fan coil units
- cooled with a single compressor in DX type equipment

The controller controls:

- a 3-speed fan
- either a valve actuator in a 2-pipe system, or
- a 3-wire ball valve actuator in a 2-pipe system, or
- a 1-stage compressor in DX type equipment

Suitable for use in systems with:

- continuous heating or cooling mode
- manual heating/cooling changeover

Functions

- Changeover between heating and cooling mode is manually
- Maintenance of room temperature with integrated temperature sensor
- Selection of operating mode with the operating mode button on the controller
- 3-speed fan control (automatic or manual)
- Output for 2-position (on/off) valve actuator, 3-wire (on/off) valve actuator or 1-stage compressor
- Button lock (automatic or manual)

Controller



Temperature control

The controller acquires the room temperature via its built-in sensor and maintains the setpoint by delivering 2-position valve control commands or compressor output commands.

The switching differential is 1 K in heating mode and 1 K in cooling mode (adjustable via parameters [P08](#) and [P09](#)).

Display

The display can show current room temperature or the setpoint adjusted by user. This can be selected via parameter [P18](#) (factory setting is the current room temperature).

The heating  and cooling  symbols on the display show the status of the fan coil. This means that the symbols are also shown while the controller operates in the dead zone.

If required, room temperature and setpoint can also be displayed in °F in place of °C by changing parameter [P17](#).

Operating modes

The following operating modes are available:

Comfort Mode

In Comfort mode, the controller maintains the setpoint, which can be adjusted via the + and – buttons. The fan can be set to automatic or manual fan speed: Low, medium or high.

Tips

The setpoint setting range can be limited to a minimum ([P05](#)) and maximum ([P06](#)). This helps prevent the waste of energy, thus saving costs.

Protection Mode

When the controller is in Protection mode , the relevant setpoints of heating or cooling are maintained. These setpoints can be adjusted via control parameters [P03](#) and [P04](#). Factory setting of [P03](#) is 8 °C; whereas [P04](#) is OFF, which means that the controller is not activated when in Protection mode.

Avoiding damage due to moisture

To avoid damage due to moisture in very warm and humid climatic zones resulting from lack of air circulation in normal operation (Comfort mode ) , the fan can be

kept running all the time (e.g. in apartments or shops during unoccupied periods), when setting parameter P21 "ON in dead zone". In this case, the fan keeps running at minimum fan speed 1.

Control sequences

Water-based fan coil application

Used in conjunction with a valve, either for heating/cooling with changeover, heating only or cooling only.

Compressor based application

Used in conjunction with a 1-stage compressor for cooling only or heating only.

Heating mode

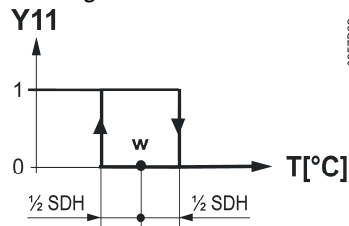

Cooling mode

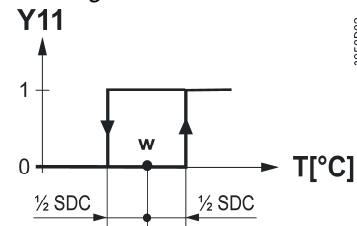

T[°C] Room temperature
W Room temperature setpoint
Y11 Control output "Valve" or "Compressor"

SDH Switching differential "Heating"
SDC Switching differential "Cooling"

ON

The valve or compressor receives **OPEN** command via control output Y11 when:

- the acquired room temperature lies by half the switching differential below the setpoint (heating mode) or above the setpoint (cooling mode), and
- control output Y11 was not energized for more than 1 minute (the "Minimum output off time" is a fix value)

OFF

The valve or compressor receives **CLOSE** command via control output Y11 when:

- the acquired room temperature lies by half the switching differential above the setpoint (heating mode) or below the setpoint (cooling mode), and
- control output Y11 was energized for more than 1 minute (the "Minimum output on time" is a fix value)

Notes: Control output Y12 delivers a control command which is inverted to the control command at output Y11 and which can be used for open valves normally.

Heat/Cool mode

When pressing the Heat/Cool mode selector, the controller will change from heating to cooling, or vice versa.

If the controller is set to "Cooling only" or "Heating only", changeover will not be possible. Only the corresponding mode can be selected by the Heat/Cool mode selector (parameter P22, factory setting is "manual changeover").

Minimum output on/off time Y11, Y12

The minimum output on/off time of Y11 and Y12 fixed at 1 minute. It means that any readjustment of the setpoint or of Heat/Cool mode changeover will be hold for 1 minute before Y11 and Y12 react.

Fan operation

The fan operates either in automatic mode or at the selected speed when using manual mode. In automatic mode, the fan speed depends on the setpoint and the current room temperature. When the room temperature reaches the setpoint, the control valve will close and the fan either remains in fan speed 1 or switches off (parameter P21, factory setting: ON in dead zone).

In "Temperature-dependent" fan control the fan switches off (see diagram below). The individual switching differentials of the fan speed 1 (Q1 only) can be adjusted

via control parameters P08 and P09. The individual switching differentials of the fan speed 2 and 3 (Q2 and Q3) are fixed at 1 K.

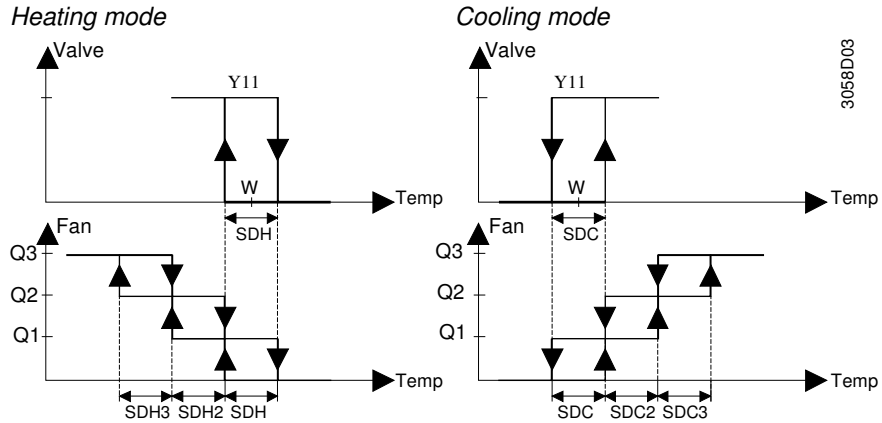

Ventilation always on

If desired, fan control can be set to “Temperature-independent”, which means that ventilation is always on, even within the dead zone, using at least fan speed 1. This can be selected individually for normal operation (Comfort mode ☀) using parameter P21. Please also refer to “Avoiding damage due to moisture”.

Dwelling time

In automatic mode, a dwelling time of 2 minutes (factory setting) is active. The fan maintains that speed for at least 2 minutes before it switches to the next speed. This dwelling time can be adjusted from 1...5 minutes using parameter P14.

Fan start

Whenever the fan starts from standstill, it starts with speed 3 for 1 second in order to guarantee a safe fan motor starts (to overcome inertia and friction).

Error handling

Temperature out of range

When the room temperature is out of the measuring range, which means above 49 °C or below 0 °C, the display shows the limiting temperature in flashing figures (“0 °C” or “49 °C”).

If the current setpoint is not OFF (see parameters P03) and the controller is in heating mode, when the temperature is below 0 °C, output Y11 will be energized. In all other cases, output Y11 will be de-energized until the temperature returns to the measuring range, and then the controller will resume Normal operation (Comfort mode ☀).

Control parameters

A number of control parameters can be readjusted to optimize the control performance. These parameters can also be set during operation without opening the unit. In the event of a power failure, all control parameter settings will be maintained.

Parameter settings

The parameters can be changed as follows:

1. Set the controller to Protection mode (⬆).
2. Press buttons + and – simultaneously for 3 seconds. Release them and, within 2 seconds, press button + again for 3 seconds. Then, the display will show “P03”.
3. Select the required parameter by repeatedly pressing buttons + and –:

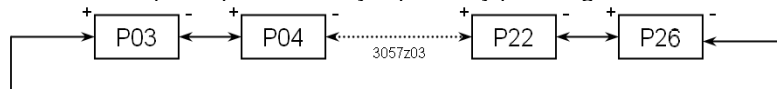

4. By pressing buttons + and – simultaneously, the current value of the selected parameter appears, which can be changed by repeatedly pressing buttons + or –.
5. By pressing buttons + and – simultaneously again, the next parameter will be display. Or, 5 seconds after the last press of the button, the last parameter will be displayed again.
6. If you wish to display and change additional parameters, repeat steps 3 through 5.
7. Otherwise, press + or – until “End” is displayed, and then press + and – simultaneously to save the change and exit parameter entry mode.

Parameter reset







The factory setting of the control parameters can be reloaded as follows:

1. Set the controller to Protection mode (⬆).
2. Press buttons + and – simultaneously for 3 seconds. Release them and, within 2 seconds, press Fan mode button twice.
3. Then, the display will show “888” during the reloading process.

Control parameter list

Parameter	Meaning	Setting range	Factory setting
P03	Setpoint of heating in Protection Mode (⬆) ($W_{heat_{Stb}}$)	OFF, 5 °C... $W_{cool_{Stb}}$	8 °C
P04	Setpoint of cooling in Protection Mode (⬆) ($W_{cool_{Stb}}$)	OFF, $W_{heat_{Stb}}$...40 °C	OFF
P05	Minimum setpoint limitation in Comfort Mode ($W_{min_{Comf}}$)	5 °C... $W_{max_{Comf}}$	5 °C
P06	Maximum setpoint limitation in Comfort Mode ($W_{max_{Comf}}$)	$W_{min_{Comf}}$...40 °C	35 °C
P07	Sensor calibration	-3...3 K	0 K
P08	Switching differential heating mode (SDH)	0.5...4 K	1 K
P09	Switching differential cooling mode (SDC)	0.5...4 K	1 K
P14	Dwelling time of auto fan speeds	1...5 mins	2 min
P17	Selection of °C or °F	°C or °F	°C
P18	Display of temperature or setpoint	OFF: Setpoint ON: Room (or return air) temperature	ON
P21	Fan control in Normal operation (Comfort mode)	OFF in dead zone ON in dead zone	ON
P22	Heat/Cool mode	0: Heating only 1: Cooling only 3: Manual H/C changover	3: Manual
P26	Button lock (Pressing 7 seconds on the operating mode button, the buttons will be locked or unlocked respectively)	0: Disabled 1: Auto lock 2: Manual lock	0: Disabled

Equipment combinations

Type of unit		Type reference	Data Sheet
Electromotoric on/off valve and actuator		MVI421.. MXI421..	N4867
Electromotoric actuator (for zone valves)		SFA21/18 SFA21..	N4863 N4863AP
Thermal actuator (for radiator valves, small valves and zone valves)		STA21...	N4877
Thermal actuator (for terminal unit valves)		STP21...	N4878
Electric actuator (for zone valves)*		SUA...	N4832
Conduit box for semi-flush-mount thermostat		ARG71 S55770-T137	N3009

*Only available in AP, UAE, SA and IN.

Ordering

When ordering, please indicate the product name, product number and SSN number:

Example: Room Thermostat, RDF510.2, S55770-T189

Valves and actuators should be ordered separately.

The controller consists of 2 parts:

- Front panel which comprised by the electronics, the operating elements and the built-in room temperature sensor
- Mounting base with the power electronics

The rear of the mounting base contains the screw terminals which fit on a rectangular conduit box with fixing centres 60.3 mm. The front panel engages in the mounting base and snaps on.

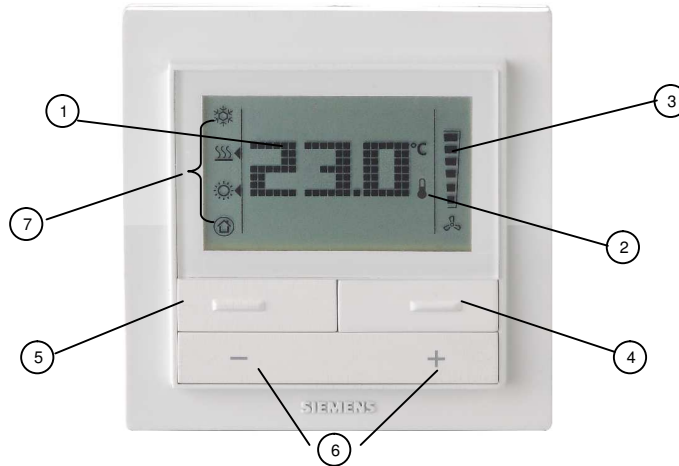

Setting and operating elements







Legend:

- ① Display of the room temperature, setpoints and control parameters
- ②  Symbol used when displaying the current room temperature
- ③ Fan mode and fan speed indicator



-  Automatic fan active
-  Manual fan active

- ④ Fan mode button
 - changing the fan mode (Auto/manual)
 - changing the fan speed (Low/Medium/High)
- ⑤ Heat/Cool mode selector
 - For the changeover between cooling mode and heating mode if P22 = 3
- Or: Operating mode button
 - For the selection of comfort mode and protection mode
- Or: Button lock
 - Press and hold for 7 seconds, to locked and unlocked the buttons manually
- ⑥ Buttons for adjusting the setpoints and control parameters
- ⑦ Mode indicator
 - Heat/Cool Mode indicator:
 -  Cooling mode active
 -  Heating mode active
 - Operating Mode indicator:
 -  Comfort mode active
 -  Protection mode active

Mounting and installation

The room controller can be mounted on a recessed rectangular conduit box with fixing centres of 60.3 mm. The mounting location on a wall should not be in niches or bookshelves, not behind curtains, above or near heat sources and wind outlet or inlet, and not exposed to direct solar radiation. Mounting height is about 1.5 m above the floor.

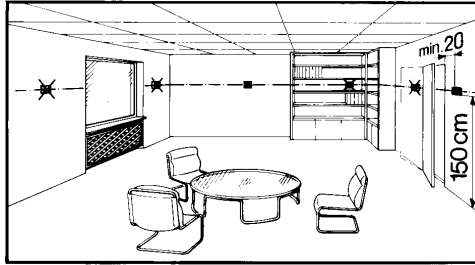

Wiring



You can also refer to the Mounting Instructions M3064 enclosed with the controller.

- Wiring, fuse and earthing must be installed in compliance with local regulations.
- The cables to the controller, fan and valves carry AC 230 V mains voltage and must be appropriate sized.
- Only valves rated for AC 230 V may be used.
- The AC 230 V mains supply line must have an external fuse or circuit breaker with a rated current of no more than 10 A.
- No metal conduits.
- No cables provided with a metal sheath.
- Disconnect from supply before opening the cover.

Commissioning

After applying power, the controller makes a reset during which all LCD segments displayed, indicating that the reset has been correctly made. This takes about 3 seconds. Then, the controller is ready for commissioning by qualified HVAC staff. The control parameters of the controller can be set to ensure optimum performance of the entire system (please refer to "[Parameter Settings](#)").

Heat/Cool mode

- Depending on the application, the Heat/Cool mode must be set via parameter [P22](#). Factory setting is "Manual Heat/Cool changeover". When using in "Cooling only" or "Heating only", [P22](#) must be set accordingly.

Calibrating sensor

- If the room temperature displayed by the controller does not accord with the room temperature effectively measured, the temperature sensor can be recalibrated. In that case, parameter [P07](#) must be changed.

Setpoint and range limitation

- For comfort and energy saving reasons, it is suggested to review the setpoints and setpoint ranges (parameters [P03](#)...[P06](#)) and, if necessary, to change them accordingly

Disposal



The device is classified as waste electronic equipment in terms of the European Directive 2002/96/EC (WEEE) and should not be disposed of as unsorted municipal waste.

Adhere to all relevant national laws.

Regarding disposal, use the systems setup for collecting electronic waste.

Observe all local and applicable laws.

Technical data

⚠ Power supply	Operating voltage	AC 230 V +10/-15%
	Frequency	50/60 Hz
	Power consumption	Max. 4 VA
Outputs	Fan control Q1, Q2, Q3-N	AC 230 V
	Rating	Max. 4(2) A
	Control output Y11-N (N.O.) / Y12-N (N.C.)	AC 230 V
Operational data	Rating	Max. 4(2) A
	Switching differential, adjustable from 0.5...4 K	
	Heating mode (factory setting)	2 K
	Cooling mode (factory setting)	1 K
	Setpoint setting range	
	☀ Normal operation (Comfort mode)	5...40 °C
	⬆ Protection mode	OFF, 5...40 °C
	Factory setting of setpoints	
	☀ Normal operation (Comfort mode)	20 °C
	⬆ Protection heating mode	8 °C
	⬆ Protection cooling mode	OFF
	Built-in room temperature sensor	
	Measuring range	0...49 °C
	Accuracy at 25 °C	<±0.5 K
	Temperature calibration range	±3 K
Resolution of settings and display		
Setpoints	0.5 °C	
Current temperature value displayed	0.5 °C	
Environmental conditions	Operation	to IEC 721-3-3
	Climatic conditions	class 3K5
	Temperature	0...50 °C
	Humidity	<95% r.h.
	Transport	to IEC 721-3-2
	Climatic conditions	class 2K3
	Temperature	-25...60 °C
	Humidity	<95 % r.h.
	Mechanical conditions	class 2M2
	Storage	to IEC 721-3-1
	Climatic conditions	class 1K3
	Temperature	-25...60 °C
Humidity	<95 % r.h.	
Norms and standards	CE conformity to	
	EMC directive	2004/108/EC
	Low voltage directive	2006/95/EC
	N474 C-Tick conformity to	
	EMC emission standard	AS/NSZ 61000.6.3:2007
 Reduction of hazardous substances		2002/95/EC

General

Product standards	
Automatic electrical controls for household and similar use	EN 60730 – 1
Special requirements for temperature-dependent controls	EN 60730 – 2-9
Electronic control type	2.B (micro-disconnection on operation)
Electromagnetic compatibility	
Emissions	IEC/EN 61 000-6-3
Immunity	IEC/EN 61 000-6-1
Devices of safety class	II as per EN 60 730
Pollution class	normal
Degree of protection of housing	IP 30 as per EN 60529
Connection terminals	solid wires or prepared stranded wires 2 x 0.4-1.5 mm ² or 1 x 0.4-2.5 mm ²
Weight	0.17 kg
Color of housing front	white, RAL 9003

Connection terminals

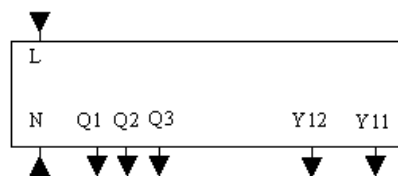

- L, N Operating voltage AC 230 V
- Q1 Control output "Fan speed 1" AC 230 V
- Q2 Control output "Fan speed 2" AC 230 V
- Q3 Control output "Fan speed 3" AC 230 V
- Y11 Control output "Valve" AC 230 V (N.O.) or output for compressor
- Y12 Control output "Valve" AC 230 V (N.C.)

Connection diagrams

Application: 2-pipe fan coil unit

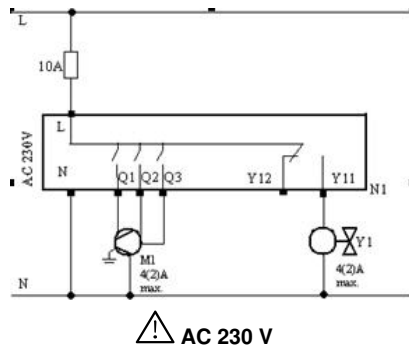

- M1 3-speed fan
- N1 RDF510.2
- Y1 Zone Valve

Application: Compressor in DX type equipment

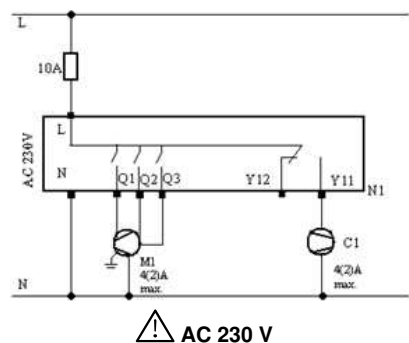

- M1 3-speed fan
- N1 RDF510.2
- C1 Compressor

Dimensions

