

Synco™ living

Consumption data interface WRI982

- Acquire all present meter values (heat/cold, hot/chilled water, electricity and gas), including monthly and due day values
- Transmits all relevant data to the central apartment units QAX903 / QAX913 via KNX RF (868 MHz bidirectional) and to the Synergry building central station OZW30
- 2 inputs for pulse meters
- 1 input for M-bus meter (M-bus MiniMaster)
- Mains-powered AC 230 V

Use

- For integration into the Siemens Synco living ECA system
- Integration into the Synergry system permitting the conversion of individual units (partial migration)
- 2 inputs for pulse meters with reed contact or pulse meters with reed contact and Namur circuitry
- 1 M-bus input (M-bus MiniMaster) to connect up to 3 M-bus meters (slave)
- Synergry building bus to communicate with the building central unit OZW30
- The following meters can be connected per consumption data interface (M-bus and pulse meters):
 - Heat meters, cold meters and combined heat/cold meters
 - Chilled and hot water meters
 - Electricity meters
 - Gas meters
 - Other meters (e.g. for steam or oil)

Equipment combinations

The consumption data interface WRI982 can be used with the following RF components from the Siemens Synco living system:

Device description	Product no.	Documentation
Central apartment unit	QAX903	N2741en
Central apartment unit	QAX913	N2740en
Radio repeater	ERF910	N2704en

Integration in Synco living

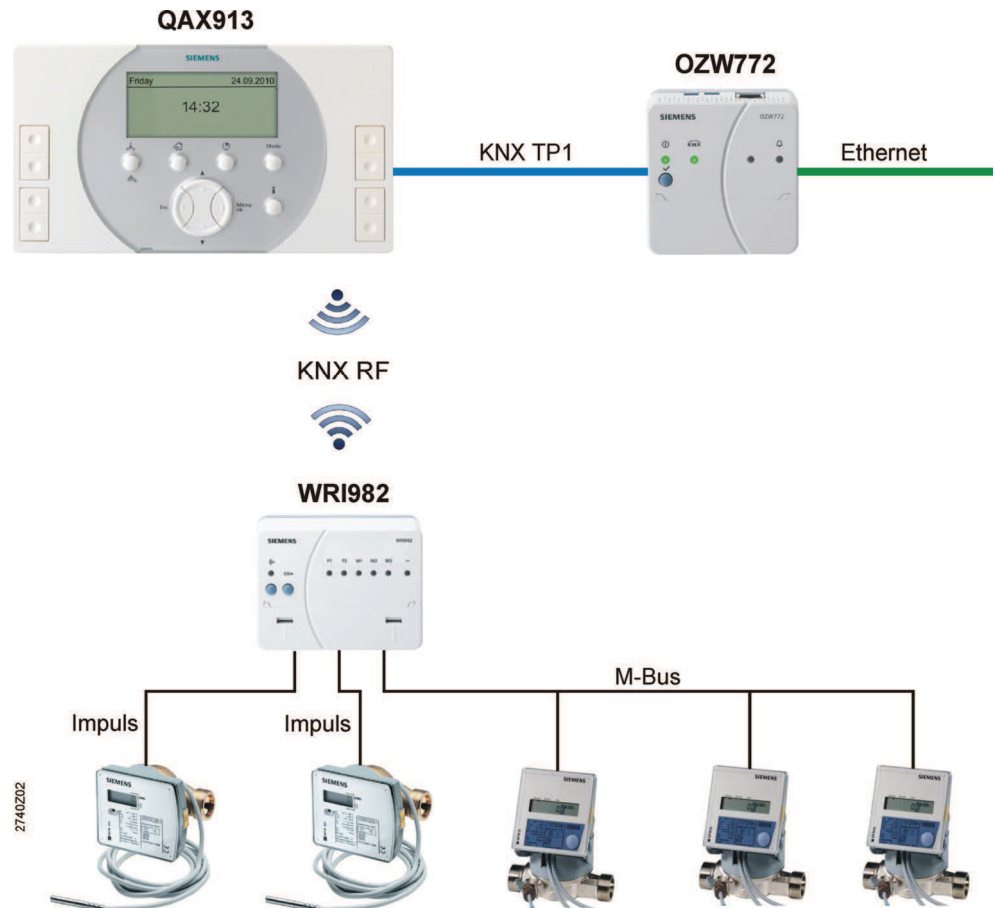

Integration in a Synergyr plant

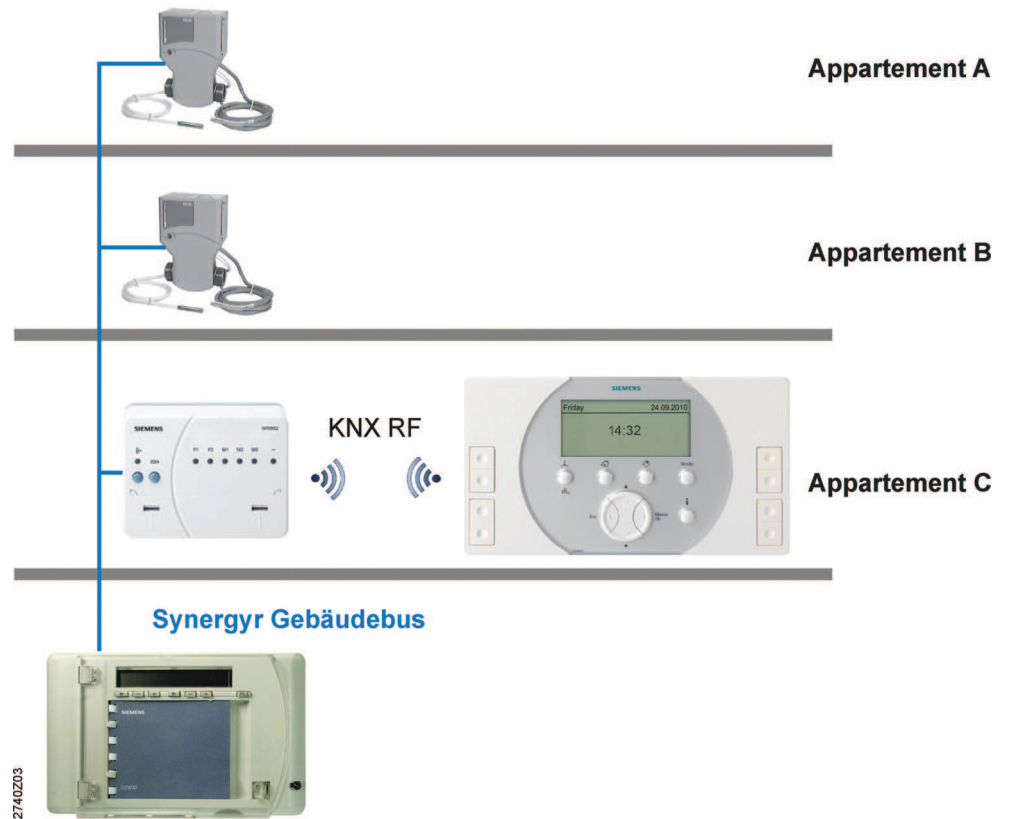

Supports M-bus meters

The WRI982 supports the following M-bus meters:

Manufacturer	Product no.	Version
Qundis	Heat meter: WFM21.. WFQ21.. WFP21.. WFO21.. WMM21.. WFN21..	All
Qundis	Water meter: WFC21.. WFH21..	All
Qundis	Pulse adapter: AEW310.2	All
Landis+Gyr	Heat meter: Ultraheat 2WR5	as of 2.05
Landis+Gyr	Heat meter: Ultraheat XS (2WR6) operates at Siemens under Sonoheat WSK...	3
Landis+Gyr	Heat meter: Ultraheat 50 (UH50) operates at Siemens under Sonoheat WSM...	4

Synergyr system components

The consumption data interface WRI982 is used with the following wired components from the Siemens Synco living system:

Device description	Product no.	Documentation
Central unit	OZW30	N2841en

Ordering

Please specify quantity, product name and type when ordering.

Scope of delivery

The WRI982 is supplied complete with Mounting Instructions.

Ordering references

Product no.	Product number	Designation
WRI982	S55621-H112	Consumption data interface

Product documentation

The Operating and Commissioning Instructions for the WRI982 are contained in the product documentation for the central apartment unit.

Functions

Main functions

The WRI982 interface acquires consumption data. The meters can be connected to one of the two pulse inputs or via M-bus. The WRI982 communicates within the HA product range either directly or via repeater with the central apartment unit via KNX RF.

The WRI982 also includes a Synergyr building bus connection to communicate with the building central station OZW30 and can be used to migrate individual units for a Synergyr system.

Specific functions to acquire consumption data

Consumption data acquisition

Integrate the consumption data interface WRI982 to display energy consumption on the central apartment unit and send it to a service provider via web server OZW772.

Monthly and due day values can be read and forwarded in addition to current meter readings. The present meter data is queried by the WRI982 every 4 hours. Historical meter data, such monthly or due day values are also queried once a day.

Synergyr integration

The Synco living ECA system is fully compatible with the Synergyr system and permit a conversion of individual units into a Synergyr system (partial migration). The meter information is displayed on the QAX903 / QAX913 central apartment unit and moreover forwarded via the Synergyr building bus to the OZW30 building central station.

Function exchange meter

The exchange meter function recognizes a change in a parameter relevant for billing.

All monthly value and due day values are set to invalid for an exchange of meters. The WRI982 also sends a request to backup the process image if the Synergyr building central unit is connected. The building central unit is informed when all changes are completed and the unit then once again saves the process image.

Device and system functions

Pulse inputs	<p>Any meter (e.g. heat, cold, water, electricity, gas) with one of the following pulse contacts can be connected to the WRI982:</p> <ul style="list-style-type: none">– Reed contact– Reed contact with NAMUR circuitry <p>The pulses are converted to consumption values per parameterization, added up and saved. Consumption values are saved:</p> <ul style="list-style-type: none">• In a momentary storage (cumulative consumption and operating hours)• In due day storage (cumulative consumption on the due day; due day can be parameterized on the central apartment unit)• For Synergyr integration only: In two additional due day storage, the last and next-to-last due day (the applicable consumption and cumulative consumption and operating hours on the due day, the due day can be parameterized in the building central stations.• In the 12-month storage (cumulative consumption at the end of the month, saved over the past 12 months).
M-bus input	<p>You can query and transmit the present meter reading, cumulative consumption as of the due day (annual), monthly values, operating hours, status, manufacturer number as well present error code for any meters connected to the M-bus.</p>
Binding	<p>A selected, channel not yet connected is connected to the central apartment unit through binding. The binding process is triggered via the multifunction button.</p>
Status query	<p>The function button query the status of channels connected to the central apartment unit. Corresponding channel LEDs indicate the state of the meter channel. The function LED flashes if no channel is connected to the central apartment unit.</p>
Channel selection	<p>The channel selection button can select individual meter channels. The function LED indicates whether the selected channel is connected to the central apartment unit.</p>
Connection test	<p>The connection test function button triggers a connection test if a channel is selected on the WRI982. The function LED indicates the connection test is running.</p>
Disconnect channel from the system	<p>The function button disconnects a channel that has already been connected, or a channel group from the system.</p>
Supply state	<p>The function button resets the WRI982 (from normal mode) to the default state as supplied. The default state is automatically achieved for WRI982 when the last channel is disconnected from it.</p>
Data backup	<p>The incoming pulse is converted into the corresponding consumption value and summed up in RAM. The consumption values (present and historical) are stored in EEPROM on a regular basis to protect against power outages. A backup is also performed at power down.</p> <p>The backup method is only used for the consumption values from the 2 pulse channels.</p>
RF failure	<p>The WRI982 sends out an error message when it fails to receive anything for more than 61 minutes.</p>

Mains failure	<p>The WRI982 can only acquire pulses as long as it has power. For this reason, the WRI982 should be powered using a separate power supply. To identify abuse, the WRI982 maintains its own operating hours and saves it to a cumulative operating hours in addition to the pulse inputs.</p> <p>We recommend using pulse adapter AEW310.2 if a separate 230 V power supply is not possible. They are battery powered and therefore not dependent on power. The pulse adapters must, however, be replaced after 12+1 years (battery life expectancy).</p>
Short circuit and interrupt protection	<p>The WRI982 can detect an interrupt or short circuit on the transmission line if the contact in the pulse transmitter is equipped with NAMUR circuitry (resistance of 2.2 kΩ in series to contact and 12 kΩ parallel throughout). Refer to "Error messages on KNX RF".</p>
Error and maintenance messages	<p>The WRI982 registers errors. Only the most serious fault is transmitted to the building central station.</p>
Error messages on KNX RF	<p>The WRI982 sends the following error messages via KNX RF:</p> <ul style="list-style-type: none"> – Short circuit or interrupt to pulse input (for Namur only) – The M-bus is not reporting (e.g. due to M-bus short circuit, M-bus failure, wrong secondary address, M-bus device missing) – Communications error or address error Synergyr building bus
Error messages on Synergyr building bus	<p>WRI982 can send the following error messages on the Synergyr building bus:</p> <ul style="list-style-type: none"> – Hardware error at heat meter – Function error at heat meter – Power at heat meter not ok – Communications error on Synergyr building bus – One (or more) M-bus participants missing – Flow sensor error on an M-bus meter – Return sensor error on an M-bus meter – One pulse input has a short circuit or interrupt – Measured values for an M-bus meter are outside limits

Operating and indicating elements

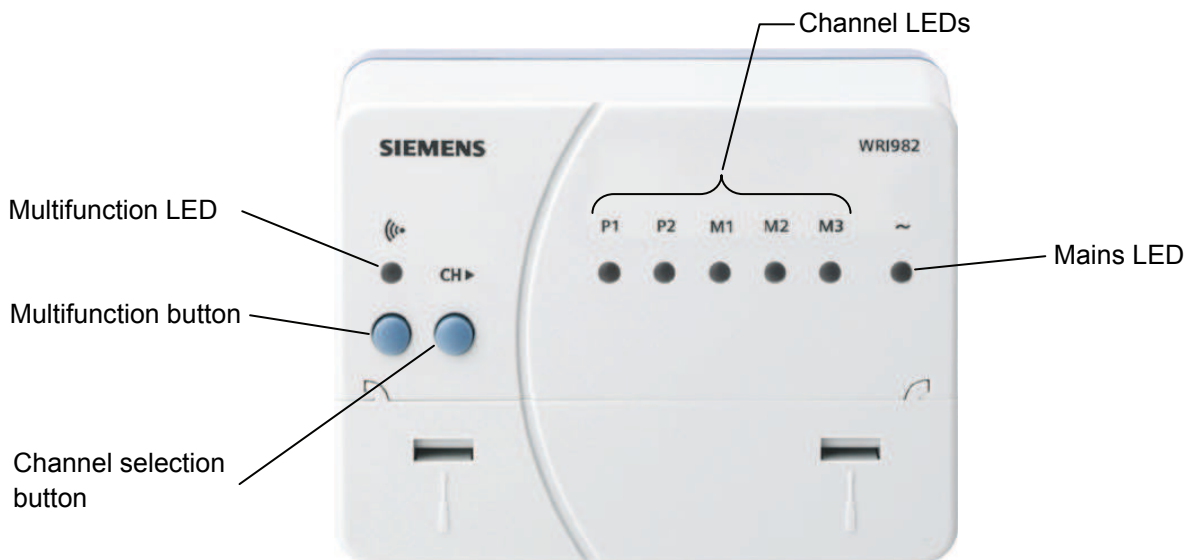

Operating element functions

Operating elements	Function
Multifunction button	State query of channel configuration Bind meter channels Connection test Disconnect channels from the system Restore to supply state
Channel selection button	Channel selection

Display element functions

Indicating element	Function
Multifunction LED	Indication of channel configuration Connection test Binding process Binding button Disconnect channel from the system
Channel LEDs: P1 / P2 M1 - M3	Display selected channels and status Pulse meter channels M-bus meter channels
Mains LED	Power supply

For more detailed information about the functions and operation of the WRI982, refer to the product documentation on the central apartment unit.

Notes on engineering and operation

Mounting location

- Comply with all local regulations on electrical systems
- Due to its compact design, the WRI982 can be fitted directly in the heat distribution panel*, on the wall or ceiling in the cellar, or in the cable riser
- The permissible environmental conditions must be observed
- The WRI982 may not be exposed to dripping water.
- For notes relating to engineering and mounting RF devices of the Siemens Synco living system, refer to Data Sheet CE1N2708en.

- When mounting the WRI982, ensure that there is sufficient space by the connection terminals to insert the cable (≥ 30 mm)
- At the top of the unit, a minimum clearance of 50 mm must be observed to ensure that the operating elements can be accessed and that the terminal cover can be easily opened

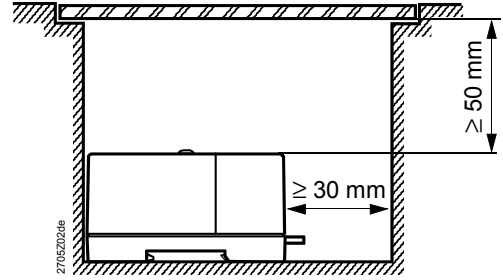

* Plastic covers are used in place of metal covers to support radio communication

Separate power recommended

The WRI982 should be connected and hard wired to a separate fused power supply to prevent potential abuse. This prevents the residents of an apartment from shutting off the WRI982 by taking out the fuse in the apartment's fuse box.

Installation

The WRI982 is designed for:

- Mounting on top hat rails conforming to EN 60715-TH35-7,5
- Fitting with the help of 2 fixing screws

Mechanical sealing

The terminal cover (after wiring the device) can be mechanically sealed to prevent manipulation of metering data.

Commissioning

Prior to commissioning, check to ensure that the WRI982 is correctly mounted, that all wiring is correct, and that power is switched on.

Maintenance

The WRI982 is maintenance free.

Disposal





In terms of disposal, the WRI982 is classified as electronic scrap conforming to the European Directive 2002/96/EG (WEEE) and may not be disposed of as domestic waste. Follow all relevant national regulations and dispose of the unit through the appropriate channels. Follow all local and currently applicable laws and regulations.

Warranty

Application-related technical data are only warranted in connection with the Siemens Synco living system. For equipment combinations, refer to the Data Sheet for the central apartment unit, CE1N2740en or CE1N2741en.

The user is responsible for ensuring that the system is operating correctly when using the WRI982 together with third-party devices. In that case, Siemens will assume no responsibility for service or warranty.

Technical data

Power supply	Operating voltage	AC 230V (+10/-15%)	
	Nominal voltage	AC 230V	
	Frequency	50 Hz	
	Power consumption (with no external load)	Max. 3.5 VA	
	External supply line fusing	<ul style="list-style-type: none"> • Non-renewable fuse to a max. 10 A • Automatic line cutout max. 13 A Release characteristic: B, C, D as per EN 60898	
RF	RF	868 MHz (bidirectional)	
	Range	Typically 30 m inside buildings	
	RF protocol	KNX RF-compatible 	
Pulse inputs	Number of pulse inputs	2 third-party meter inputs	
	Data direction	Input (not galvanically isolated)	
	Maximum pulse frequency	25 Hz	
	Minimum pulse length	20 ms	
	Quiescent level	0/12 V DC	(Reed)
		1.5/10 V DC	(Reed with NAMUR)
	Cable cross-section	Copper cable 0.6 mm ²	
Permissible cable length	Max. 30 m		
M-bus master	Mechanical design	2-wire connection, interchangeable	
	Data direction	Half-duplex, hierarchical	
	Baud rate	2400 Baud	
	Quiescent level	27-28 V DC	
	Maximum supply current	27.5 mA	
	Cable cross-section	Copper cable 0.6 mm ²	
	Permissible cable length	Max. 100 m	
	Number of M-bus slaves	Max. 3	
Synergry building bus	Data direction	Half-duplex	
	Baud rate	4800 Baud	
	Quiescent level	DC 16V	
	Bus wiring	2-wire, non-interchangeable, galvanically isolated	
	Permissible cable length	As per engineering manual WRI80 (CE1J2802), for partial migration, the plant determines the bus cable length.	
Electrical connections	Screw terminals for	Max. 2.5 mm ²	
Standards and directives	 conformity to EEC directive - Immunity, emissions	2004/108/EC	
		- EN 61000-6-1, EN 61000-6-2, EN 61000-6-3 (suitable for use in residential and industrial environments)	
	Low-voltage directive - Electrical safety	2006/95/EC - EN 60950-1	
	RTTE Radio & Telecom. Equipment) - Radio communication	1999/5/EC - EN 300220-2, EN 301489-1, EN 301489-3	

Protection	Safety class	II to EN 60730		
	Degree of protection of housing	IP30 to EN 60529		
	Degree of pollution	2 to EN 60730		
Environmental compatibility	Environmental Declaration CM1E2735en contains data on environmental-compatible product design and assessment (RoHS compliance, compositions, packaging, environmental benefits and disposal)	ISO 14001 (environment)	ISO 9001 (quality)	SN 36350 (environment-compatible products)
		RL 2002/95/EG (RoHS)		
Dimensions		Refer to "Dimensions"		
Weight	Unit complete with accessories	0.379 kg		
Housing material		Plastics PC+ABS		
Housing colors	Upper / lower housing section	RAL 7035 light-gray		
		RAL 5014 dove-blue		
Environmental conditions		Operation EN 60721-3-3	Transport EN 60721-3-2	Storage EN 60721-3-1
	Climatic conditions	Class 3K5	Class 2K3	Class 1K3
	Temperature	0...+50 °C	-25...+70 °C	-20...+65 °C
	Humidity	< 95 % r.h. (noncondensing)	<95% r.h.	< 95 % r.h. (noncondensing)
	Mechanical conditions	Class 3M2	Class 2M2	Class 1M2
	Elevation above sea level	Min. 700 hPa, Max. 3,000 m above sea level		

Connection terminals



P1, P2	Pulse meter inputs (reed contact with or without NAMUR circuitry)
M	Measurement for pulse meter input
CM+	Data M-bus
CM-	Measure M-bus
DB	Data Synergyr building bus
MB	Measurements Synergyr building bus
L	Operating voltage, live wire AC 230 V
N	Operating voltage, neutral conductor AC 230 V

Connection diagram

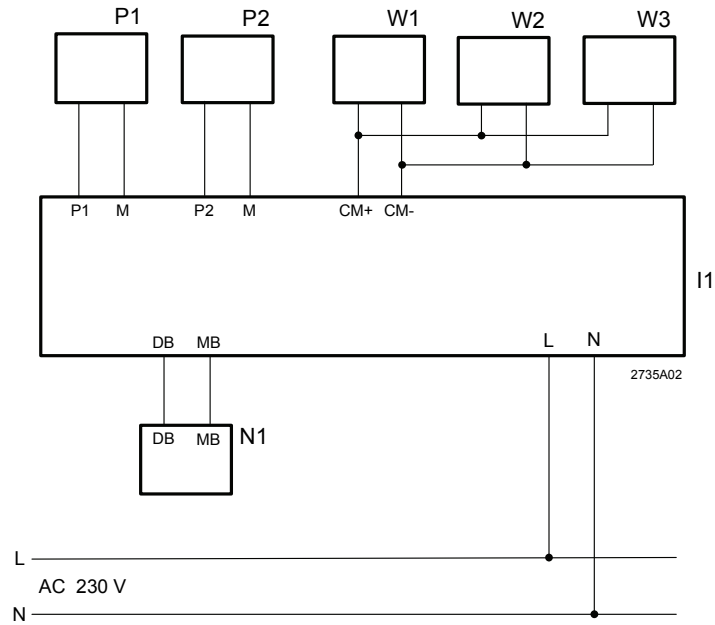

- P1, P2 Third-party meter with potential-free pulse contact, e.g. for hot water, chilled water, electricity, etc.
 W1...W3 Heat meter
 N1 Central unit OZW30
 I1 Consumption data interface WRI982

Dimensions

Dimensions in mm

