



Room thermostats with KNX communications

RDG100KN
RDG160KN

- For fan coil unit applications
- For universal applications
- For use with compressor in DX type equipment

-
- **KNX bus communication (S-mode and LTE mode)**
 - **Backlit display**
 - **2P / PI / P control**
 - **Outputs for On/Off, PWM, 3-position or DC 0...10 V control**
 - **Outputs for 3-speed, 1-speed, or DC (DC 0...10 V) fan**
 - **3 multifunctional inputs for keycard contact, external sensor, etc.**
 - **Operating modes: Comfort, Economy and Protection**
 - **Automatic or manual fan speed control**
 - **Automatic or manual heating / cooling changeover**
 - **Minimum and maximum limitation of room temperature setpoint**
 - **Control depending on the room or the return air temperature**
 - **Selectable relay output functions (RDG160KN)**
 - **Adjustable commissioning and control parameters**
 - **Commissioning with Synco ACS, ETS or via local HMI**
 - **Integration into Synco**
 - **Integration into Desigo via group addressing (ETS) or via individual addressing**
 - **Integration into third-party system via group addressing (ETS)**
 - **Operating voltage:**
RDG100KN: AC 230 V
RDG160KN: AC 24 V

The RDG1...KN room thermostats are designed for use with the following types of system:

Fan coil units via On/Off or modulating / DC control outputs:

- 2-pipe system
- 2-pipe system with electric heater
- 2-pipe system and radiator / floor heating
- 4-pipe system
- 4-pipe system with electric heater (RDG100KN)
- 2-stage heating or cooling system

Chilled / heated ceilings (or radiators) via On/Off or modulating / DC control outputs:

- Chilled / heated ceiling
- Chilled / heated ceiling with electric heater
- Chilled / heated ceiling and radiator / floor heating
- Chilled / heated ceiling, 2-stage cooling or heating

Compressor application via On/Off control (RDG160KN)

- Compressors in DX-type equipment
- Compressors in DX-type equipment with electric heater
- Compressors in DX-type equipment with Radiator
- 2-stage compressors in DX-type equipment for heating or cooling

The RDG100KN controls ...

- One single or 3-speed fan
- One or two On/Off / PWM / 3-position valve actuators
- One valve actuator and one electric heater / Radiator

The RDG160KN controls ...

- One single, 3-speed or DC 0...10 V fan
- One or two On/Off valve actuators / el. Heater / radiator with DC fan
- One or two DC valve actuators / el. Heater / radiator with DC fan
- One or two DC valve actuators / el. Heater / radiator with 1 / 3-speed fan
- One On/Off valve actuator, one DC valve actuator with DC fan
- 1 or 2-stage compressor in DX-type equipment, with electric heater / radiator

Used in systems with:

- Heating or cooling mode
- Automatic heating/cooling changeover
- Manual heating/cooling changeover
- Heating and cooling mode (e.g. 4-pipe system)

The room thermostats are delivered with a fixed set of applications.

The relevant application is selected and activated during commissioning using one of the following tools:

- Synco ACS
- ETS
- Local DIP switch and HMI

- Room temperature control via built-in temperature sensor or external room temperature / return air temperature sensor
- Changeover between heating and cooling mode (automatic via local sensor or bus, or manual)
- Selection of applications via DIP switches or commissioning tool (ACS, ETS)
- Select operating mode via operating mode button on the thermostat
- Parameters download with commissioning tool (ACS, ETS)
- Temporary Comfort mode extension
- Single speed, 3-speed or DC 0...10 V fan control (automatic or manual)
- Display of current room temperature or setpoint in °C and/or °F
- Minimum and maximum limitation of room temperature setpoint
- Button lock (automatic or manual)
- 3 multifunctional inputs, freely selectable for:
 - Operating mode switchover contact (keycard, window contact, etc.)
 - Sensor for automatic heating / cooling changeover
 - External room temperature or return air temperature sensor
 - Dewpoint sensor
 - Electric heater enable
 - Fault input
 - Monitor input for temperature sensor or switch status
 - Supply air temperature sensor (RDG160KN)
- Advanced fan control function, e.g. fan kick, fan start delay, selectable fan operation (enable, disable or depending on heating or cooling mode)
- Purge function together with 2-port valve in a 2-pipe changeover system
- Reminder to clean fan filters
- Floor heating temperature limitation
- Minimum and maximum supply air temperature limitation (RDG160KN)
- Reload factory settings for commissioning and control parameters
- KNX bus (terminals CE+ and CE-) for communication with Synco or KNX compatible devices
- Display of outside temperature or time of day via KNX bus
- Time scheduling and central control of setpoints via KNX bus
- With a Synco RMB7xx controller, the energy demand signal of the thermostat is used to optimize energy supply
- Selectable relay function for switching external equipment (RDG160KN)

Applications

The thermostats support the following applications, which can be configured using the DIP switches at the rear of the unit or a commissioning tool.

Remote configuration

DIP switches 1...3 need to be set to OFF (remote configuration, factory setting) to select an application via commissioning tool.

| | |
|---|--|
| <p>Remote configuration, via commissioning tool (factory set)</p> <ul style="list-style-type: none"> • Synco ACS • ETS | <p>DIP switches</p>  |
|---|--|

Applications for fan coil systems

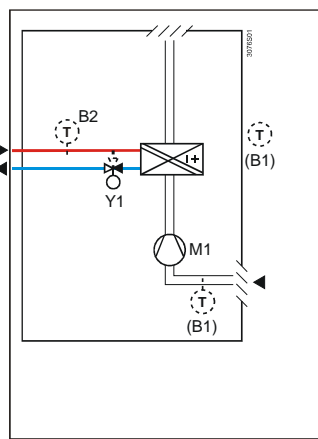
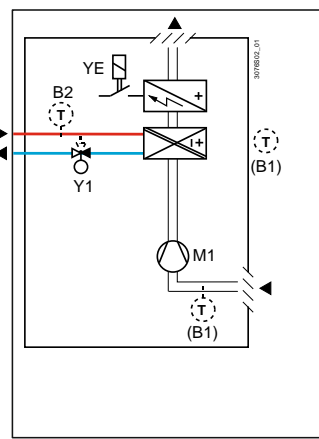
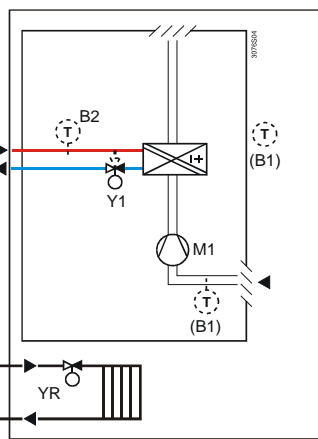
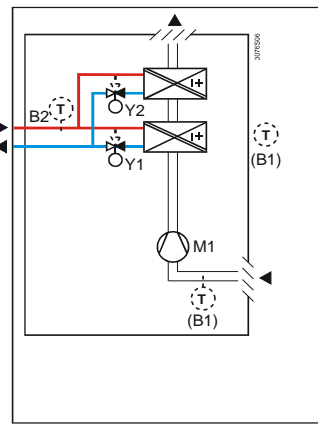
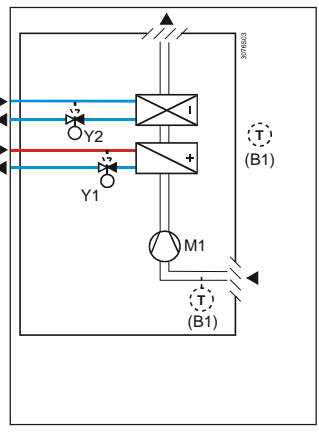
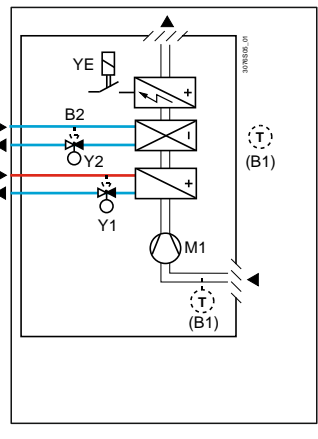
| Applications, DIP setting, Control outputs | | |
|---|--|---|
| <p>• 2-pipe fan coil unit</p>  <p>Using RDG100KN, RDG160KN</p> | <p>• 2-pipe fan coil unit and electric heater</p>  <p>Using RDG100KN, RDG160KN</p> | <p>• 2-pipe fan coil unit and radiator / floor heating</p>  <p>Using RDG100KN, RDG160KN</p> |
| <p>• 2-pipe / 2-stage fan coil unit</p>  <p>Using RDG100KN, RDG160KN</p> | <p>• 4-pipe fan coil unit</p>  <p>Using RDG100KN, RDG160KN</p> | <p>• 4-pipe fan coil unit and electric heater</p>  <p>Using RDG100KN</p> |

| Product no. | Control outputs | Fan |
|-------------|-------------------------|-------------------------------|
| RDG100KN | On/Off, PWM, 3-position | 3-speed, 1-speed |
| RDG160KN | DC 0...10 V | 3-speed, 1-speed, DC 0...10 V |
| RDG160KN | On/Off | DC 0...10 V |

Applications for Universal systems

| Applications, DIP setting, Control outputs | | |
|--|--|---|
| <ul style="list-style-type: none"> Chilled / heated ceiling <p>ON OFF 1 2 3 4 5</p> <p>Using RDG100KN, RDG160KN</p> | <ul style="list-style-type: none"> Chilled / heated ceiling and electric heater <p>ON OFF 1 2 3 4 5</p> <p>Using RDG100KN, RDG160KN</p> | <ul style="list-style-type: none"> Chilled / heated ceiling and radiator / floor heating <p>ON OFF 1 2 3 4 5</p> <p>Using RDG100KN, RDG160KN</p> |
| <ul style="list-style-type: none"> 2-stage chilled / heated ceiling <p>ON OFF 1 2 3 4 5</p> <p>Using RDG100KN, RDG160KN</p> | <ul style="list-style-type: none"> Chilled ceiling and radiator <p>ON OFF 1 2 3 4 5</p> <p>Using RDG100KN, RDG160KN</p> | |

| Product no. | Control outputs |
|-------------|-------------------------|
| RDG100KN | On/Off, PWM, 3-position |
| RDG160KN | On/Off, DC 0...10 V |

Applications for heat pump systems (RDG160KN)

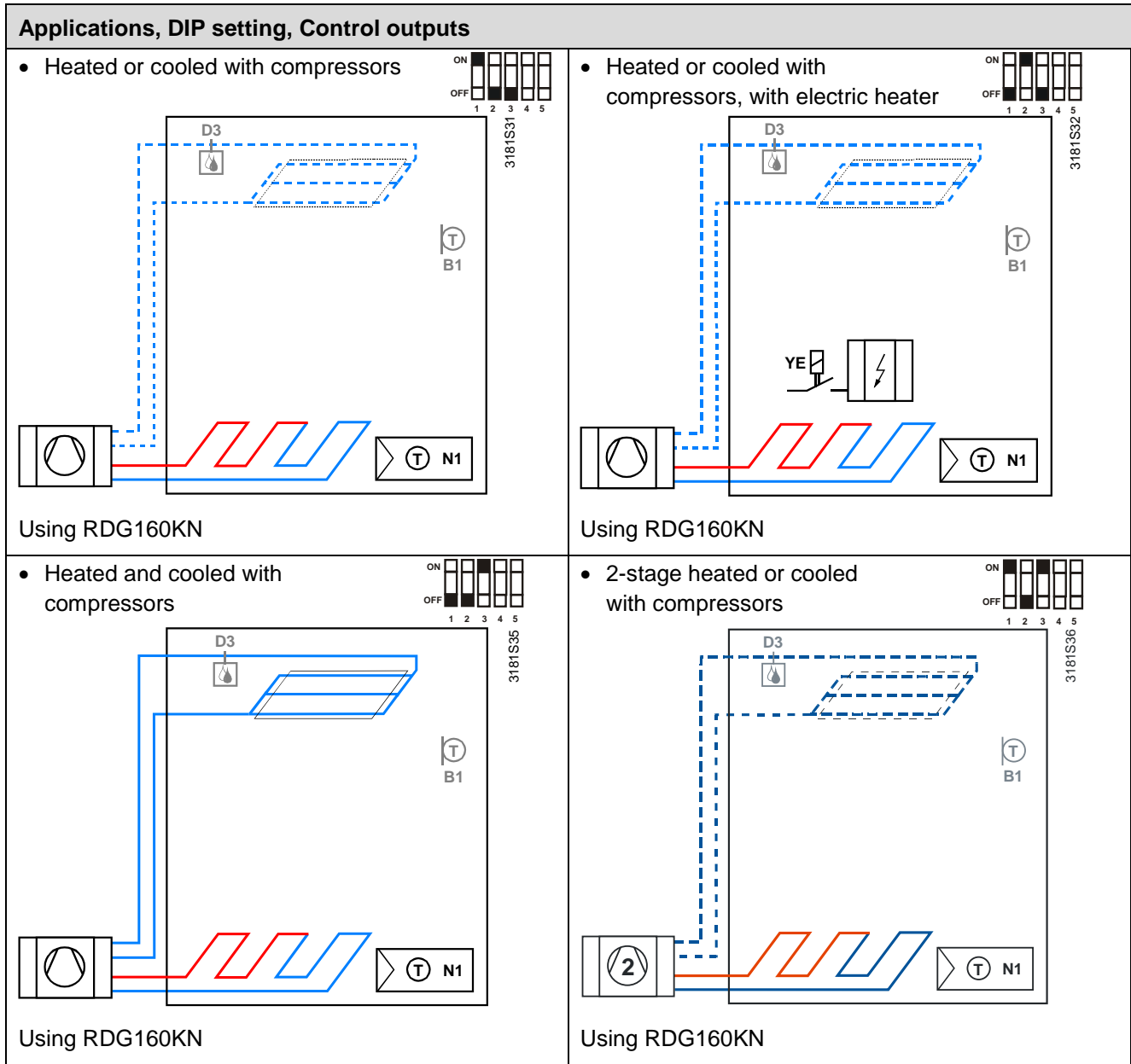

| Product no. | Control outputs | Fan |
|-------------|----------------------|-----------------------|
| RDG160KN | On/Off , DC 0...10 V | Disabled, DC 0...10 V |

- Key
- Y1 Heating or heating / cooling valve actuator
 - Y2 Cooling valve actuator
 - YE Electric heater
 - M1 1-speed or 3-speed fan
 - B1 Return air temperature sensor or external room temperature sensor (optional)
 - B2 Changeover sensor (optional)

Notes RDG100KN

- Use P46 / P47 to change output from On / Off (factory setting) to PWM
- Use DIP switches 4 and 5 to change output from On/Off to 3-position

RDG160KN

- Use P46 / P47 to change valve actuator output from DC (factory setting) to On/Off
- Use DIP switch 4 to change fan output from DC (factory setting) to 3-speed

Type summary

















| Product no. | Stock no. | Features | | | | | | | |
|-------------|-------------|-------------------|---------------------------|-----------------|-----------------|-----------------|-----------------|----|-------------|
| | | Operating voltage | Number of control outputs | | | | Fan | | Backlit LCD |
| | | | On/Off | PWM | 3-pos. | DC | 3-stage | DC | |
| RDG100KN | S55770-T163 | AC 230 V | 3 ¹⁾ | 2 ¹⁾ | 2 ¹⁾ | | ✓ | | ✓ |
| RDG160KN | S55770-T297 | AC 24 V | 2 ²⁾ | | | 2 ²⁾ | | ✓ | ✓ |
| | | | | | | 2 | ✓ ³⁾ | | |

1) Selectable: On/Off, PWM or 3-position (triac outputs)









2) Either On/Off or DC control signal

3) 3-speed fan selectable only with DC outputs

Equipment combinations

| | Description | | Product no. | Data sheet |
|-------------------------------|--|---|--|------------|
| | Cable temperature or changeover sensor |  | QAH11.1 | 1840 |
| | Room temperature sensor |  | QAA32 | 1747 |
| | Condensation motion |  | QXA2601 / QXA2602 / QXA2603 / QXA2604 | 3302 |
| On / off actuators | Electromotoric On/Off actuator |  | SFA21... | 4863 |
| | Electromotoric On/Off valve and actuator (only available in AP, UAE, SA and IN) |  | MVI... / MXI... | 4867 |
| | Zone valve actuator (only available in AP, UAE, SA and IN) |  | SUA... | 4832 |
| On / off and PWM actuators *) | Thermal actuator (for radiator valves) AC 230 V, NO |  | STA23... *) | 4884 *) |
| | Thermal actuator (for radiator valves) AC 24 V, NO |  | STA73... *) | 4884 *) |
| | Thermal actuator AC 230 V (for small valves 2.5 mm), NC |  | STP23... *) | 4884 *) |
| | Thermal actuator AC 24 V (for small valves 2.5 mm), NC |  | STP73... *) | 4884 *) |
| 3-position actuators | Electrical actuator, 3-position (for radiator valves) |  | SSA31... | 4893 |
| | Electrical actuator, 3-position (for 2- and 3-port valves / V...P45) |  | SSC31 | 4895 |
| | Electrical actuator, 3-position (for small valves 2.5 mm) |  | SSP31... | 4864 |
| | Electrical actuator, 3-position (for small valves 5.5 mm) |  | SSB31... | 4891 |
| | Electrical actuator, 3-position (for small valve 5,5 mm) |  | SSD31... | 4861 |
| | Electromotoric actuator, 3-position (for valves 5.5 mm) |  | SQS35... | 4573 |

DC 0...10 V actuators

| | | | |
|--|--|-----------------|------|
| Electrical actuator, DC 0...10 V (for radiator valves) |  | SSA61... | 4893 |
| Electrical actuator, DC 0...10 V (for 2- and 3-port valves / V...P45) |  | SSC61... | 4895 |
| Electrical actuator, DC 0...10 V (for small valves 2.5 mm) |  | SSP61... | 4864 |
| Electrical actuator, DC 0...10 V (for small valves 5.5 mm) |  | SSB61... | 4891 |
| Electrical actuator, DC 0...10 V (for CombiValves VPI45) |  | SSD61... | 4861 |
| Electromotoric actuator, DC 0...10 V (for valves 5.5 mm) |  | SQS65... | 4573 |
| Electrothermal actuator, AC 24 V, NC, DC 0...10 V, 1 m |  | STA63 | 4884 |
| Electrothermal actuator, AC 24 V, NO, DC 0...10 V, 1 m |  | STP63 | 4884 |

*) With PWM control, it is not possible to ensure exact parallel running of more than one thermal actuator.

If several fan-coil systems are controlled by the same room thermostat, preference should be given to motorized actuators with On/Off or 3-position control.

Note: For the parallel operation of the actuators, refer to information in the data sheets of the selected actuators and to this list, depending on which value is lower:

Maximum number of actuators in parallel on the RDG100KN

- max 6 SS...31.. actuators (3-pos)
- max 4 ST...23.. if used with On/Off control signal
- max 10 SFA., SUA., MVI., MXI.. On/Off actuators
- Parallel operation of SQS35 is NOT possible

Maximum number of actuators in parallel on the RDG160KN

- max 10 SS...61.. actuators (DC)
- max 10 ST..23/63/73... actuators (DC or On/Off)
- max 10 SFA., SUA., MVI., MXI ... On/Off actuators
- max 10 SQS65 actuators (DC)

Accessories

| Description | Product no. / stock no. | Data sheet |
|---|-------------------------|------------|
| KNX Power supply 160 mA (Siemens BT LV) | 5WG1 125-1AB02 | -- |
| KNX Power supply 320 mA (Siemens BT LV) | 5WG1 125-1AB12 | -- |
| KNX Power supply 640 mA (Siemens BT LV) | 5WG1 125-1AB22 | -- |

Mechanical design

The room thermostat consists of 2 parts:

- Plastic housing with electronics, operating elements and room temperature sensor
- Mounting plate with the screw terminals

The housing engages in the mounting plate and is secured with 2 screws.

Operation and settings

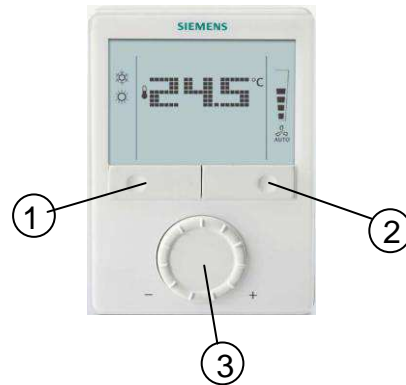

- 1) Operating mode button / Esc
- 2) Fan mode button / Ok
- 3) Rotary knob to adjust setpoints and parameters

Display

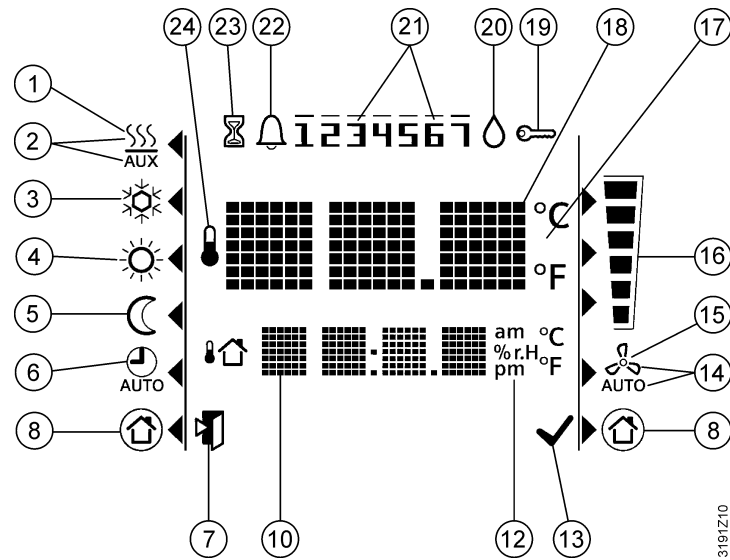

| # | Symbol | Description | # | Symbol | Description | |
|----|--------|---|----|--------|--|-------------|
| 1 | | Heating mode | 14 | | Automatic fan | |
| 2 | | Heating mode, electric heater active | 15 | | Manual fan | |
| 3 | | Cooling mode | 16 | | | Fan speed 1 |
| 4 | | Comfort | | | | Fan speed 2 |
| 5 | | Economy | | | | Fan speed 3 |
| 6 | | Auto Timer mode according to schedule (via KNX) | 17 | | Degrees Celsius Degrees Fahrenheit | |
| 8 | | Protection mode | 18 | | Digits for room temperature and setpoint display | |
| 9 | | Escape | 19 | | Button lock | |
| 10 | | Additional user information, like outdoor temperature or time of day from KNX bus. Selectable via parameters | 20 | | Condensation in room (dewpoint sensor active) | |
| 12 | | Morning: 12-hour format Afternoon: 12-hour format | 21 | | Weekday 1...7 from KNX bus 1 = Monday / 7 = Sunday | |
| 13 | | Confirmation of parameters | 22 | | Fault | |
| | | | 23 | | Temporary timer function; visible when operating mode is temporarily extended (extended presence or absence) | |
| | | | 24 | | Indicates that room temperature is displayed | |

See the "Reference documentation", page 17 for information on how to engineer the KNX bus (topology, bus repeaters, etc.) and how to select and dimension connecting cables for supply voltage and field devices.

Mounting and installation

Do not mount on a wall in niches or bookshelves, behind curtains, above or near heat sources, or exposed to direct solar radiation. Mount about 1.5 m above the floor.

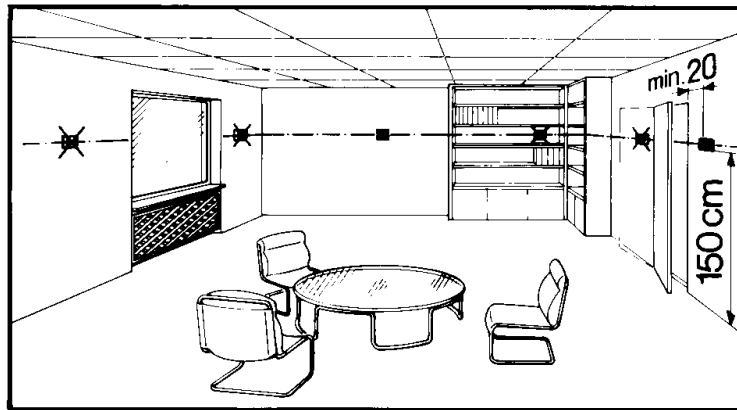

Mounting



- Mount the room thermostat on a clean, dry indoor place without direct airflow from a heating / cooling device, and not exposed to drips or splash water.

Wiring

See the mounting instructions M3191 enclosed with the thermostat.



- Comply with local regulations to wire, protection and earth the thermostat.
- The device has no internal fuse for supply lines to fan and actuators. To avoid risk of fire and injury due to short-circuits, the AC 230 V mains supply line must have a circuit breaker with a rated current of no more than 10 A.



- Properly size the cables to the thermostat, fan and valve actuators for AC 230 V mains voltage.



- Use only valve actuators rated for AC 230 V.



- The wiring cross section used for power supply (L, N), fan (Q1, Q2, Q3, N) and 230 V outputs (Yx - N) must be adapted to the preceding overload protection elements (10A) under all circumstances. Comply under all circumstances with local regulations.



- Isolate the cables of input D1-GND for 230 V if the conduit box carries AC 230 V mains voltage.
- X1-M, X2-M or D1-GND: several switches (e.g. summer/winter switch) may be connected in parallel. Consider overall maximum contact sensing current for switch rating.
- Inputs X1-M and X2-M carry mains potential (RDG100KN only). Sensor cables must be suited for AC 230 V mains voltage
- Selectable relay function (RDG160KN): Follow instructions in P3191 to connect external equipment to the relay outputs.
- Isolate the cables of KNX communication input CE+ / CE- for 230 V if the conduit box carries AC 230 V mains voltage.
- No cables provided with a metal sheath.
- Disconnect from supply before removing from the mounting plate.



- When a KNX bus power supply is connected on the line with communicating thermostats and Synco controller, the internal KNX power supply of the Synco controllers must be switched off.

Commissioning notes

Applications

The room thermostats are delivered with a fixed set of applications.

Select and activate the relevant application during commissioning using one of the following tools:

- Local DIP switch and HMI
- Synco ACS
- ETS

Set the DIP switches before snapping the thermostat to the mounting plate, if you want to select an application via **DIP switches**.

All DIP switches need to be set to "OFF" ("remote configuration"), if you want to select an application via **commissioning tool**.

After power is applied, the thermostat resets and all LCD segments flash, indicating that the reset was correct. After the reset, which takes about 3 seconds, the thermostat is ready for commissioning by qualified HVAC staff.

If all DIP switches are OFF, the display reads "NO APPL" to indicate that application commissioning via a tool is required.

Note Each time the application is changed, the thermostat reloads the factory setting for all control parameters, except for KNX device and zone addresses!

Connect tool

Connect the Synco ACS or ETS tools to the KNX bus cable at any point for commissioning:

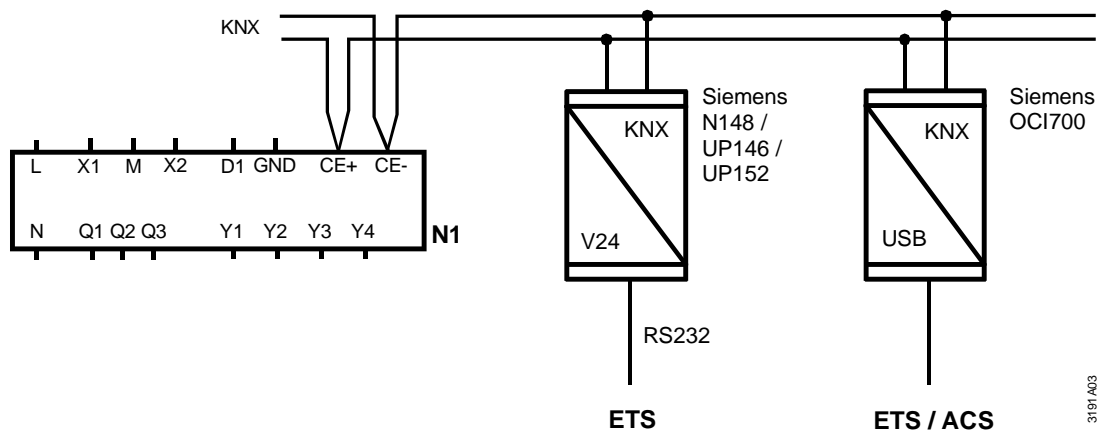

ACS and ETS require an interface:

- RS232 KNX interface (e.g. Siemens N148 / UP146 / UP152)
- OCI700 USB- KNX interface

Note An external KNX bus power supply is required if an RDG1...KN is connected directly to a tool (ACS or ETS) via KNX interface.

Control parameters

The thermostat's control parameters can be set to ensure optimum performance of the entire system (see basic documentation P3191).

The parameters can be adjusted using

- Local HMI
- Synco ACS
- ETS

Control sequence

- The control sequence may need to be set via parameter P01 depending on the application. The factory setting is as follows:

| Application | Factory setting P01 |
|--|-------------------------|
| 2-pipe and chilled / heated ceiling, and 2-stage | 1 = Cooling only |
| 4-pipe, chilled ceiling and radiator | 4 = Heating and cooling |

Calibrate sensor

- Recalibrate the temperature sensor if the room temperature displayed on the thermostat does not match the room temperature measured (after min. 1 hour of operation). To do this, change parameter P05.

Setpoint and range limitation

- We recommend to review the setpoints and setpoint ranges (parameters P08...P12) and change them as needed to achieve maximum comfort and save energy.

Programming mode

The programming mode helps identify the thermostat in the KNX network during commissioning.

Press the left and right buttons simultaneously for 6 sec to activate programming mode, which is indicated on the display with "PrO9".

Programming mode remains active until thermostat identification is complete.

Assign KNX group addresses

Use ETS to assign the KNX group addresses of the RDG communication objects.

KNX serial number

Each device has a unique KNX serial number inside the plastic housing.

An additional sticker with the same KNX serial number is enclosed in the packaging box. This sticker is intended for installers for documentation purposes.

Disposal



The devices are considered electronics devices for disposal in terms of European Directive 2012/19/EU and may not be disposed of as domestic waste.

- Dispose of the device via the channels provided for this purpose.
- Comply with all local and currently applicable laws and regulations.

Technical data

RDG100KN

| | | |
|--|--|--|
| ⚠ Power supply | Rated voltage | AC 230 V |
| | Frequency | 50/60 Hz |
| | Power consumption | Max. 8 VA / 1 W |
| Caution ⚠ | No internal fuse | |
| | External preliminary protection with max. C 10 A circuit breaker required in all cases | |
| Outputs | Fan control Q1, Q2, Q3 – NAC 230 V | |
| | Rating min, max resistive (inductive) | 5 mA...5(4) A |
| Caution ⚠ | No internal fuse | |
| | External preliminary protection with max. C 10 A circuit breaker in the supply line required under all circumstances | |
| ⛔ Note! | Fans must NOT be connected in parallel! | |
| | Connect one fan directly, for additional fans, one relay for each speed. | |
| | Control outputs | Solid state (Triac) |
| | Y1, Y2, Y3, Y4-N | AC 230 V, 8mA...1 A |
| | Power limitation | 3 A fast microfuse, cannot be exchanged |
| Inputs | Multifunctional inputs | |
| | X1-M / X2-M | |
| | Temperature sensor input | |
| | Type | QAH11.1 (NTC) |
| | Temperature range | 0...49 °C |
| | Cable length | Max. 80 m |
| | Digital input | |
| | Operating action | Selectable (NO/NC) |
| | Contact sensing | DC 0...5 V, max. 5 mA |
| | Parallel connection of several thermostats for one switch | Max. 20 thermostats per switch. Do not mix with D1! |
| | Insulation against mains | N/A, mains potential ⚠ |
| | D1-GND | |
| | Operating action | Selectable (NO/NC) |
| | Contact sensing | SELV DC 6...15 V, 3...6 mA |
| | Parallel connection of several thermostats for one switch | Max. 20 thermostats per switch. |
| Insulation against mains | Do not mix with X1 / X2! 3.75 kV, reinforced insulation | |
| Function of inputs | Selectable | |
| External temperature sensor, heating/cooling changeover sensor, operating mode switchover contact, dewpoint monitor contact, enable electric heater contact, fault contact, monitoring input | X1: P38 X2: P40 D1: P42 | |

RDG160KN

 Power supply

| | |
|---|-----------------|
| Rated voltage | AC 24 V |
| DC 24 V : Make sure to connect G to + and G0 to - | DC 24 V |
| Frequency | 50/60 Hz |
| Power consumption | Max. 2 VA / 2 W |

Caution 

No internal fuse
External preliminary protection with max. C 10 A circuit breaker
required in all cases

Outputs

| | |
|------------------------------|---------------|
| Q1 / Q2 / Q3 / L - N (relay) | AC 24...230 V |
|------------------------------|---------------|

Use for 3-speed fan control

| | |
|---------------------------------------|---------------|
| Rating min, max resistive (inductive) | 5 mA...5(4) A |
|---------------------------------------|---------------|

Fans must NOT be connected in parallel!

Connect one fan directly, for additional fans, one relay for each speed.

Use for actuator control (Q1, Q2)

| | |
|--|------------|
| Q1 - rating min, max resistive (inductive) | 5 mA...1 A |
|--|------------|

| | |
|--|---------------|
| Q2 - rating min, max resistive (inductive) | 5 mA...5(4) A |
|--|---------------|

Use for external equipment (Q3)

| | |
|--|------------|
| Rating min, max resistive / inductive Qx | 5 mA...1 A |
|--|------------|

Caution 

No internal fuse
External preliminary protection with max. C 10 A circuit breaker in the supply line
required under all circumstances

| | | |
|-----------------|----------|---------------------------------|
| ECM fan control | Y50 - G0 | SELV DC 0...10 V, Max. ±5 mA |
|-----------------|----------|---------------------------------|

| | | |
|------------------|-------------------------|---------------------------------|
| Actuator control | Y10 - G0 / Y20 - G0 (G) | SELV DC 0...10 V, Max. ±1 mA |
|------------------|-------------------------|---------------------------------|

Inputs

| | |
|------------------------|------|
| Multifunctional inputs | SELV |
|------------------------|------|

X1-M / X2-M

Temperature sensor input

Type

QAH11.1 (NTC)

Temperature range

0...49 °C

Cable length

Max. 80 m

Digital input

Operating action

Selectable (NO/NC)

Contact sensing

DC 0...5 V, max. 5 mA

Parallel connection of several
thermostats for one switch

Max. 20 thermostats per
switch

D1-GND

Operating action

Selectable (NO/NC)

Contact sensing

DC 6...15 V, 3...6 mA

Parallel connection of several
thermostats for one switch

Max. 20 thermostats per
switch.



Function of inputs

Selectable

| | |
|---|-------------------------------|
| External room temperature sensor, heating/cooling changeover sensor, operating mode switchover contact, dewpoint monitor contact, enable electric heater contact, fault contact, monitoring input, supply air temperature | X1: P38 X2: P40 D1: P42 |
|---|-------------------------------|

RDG100KN, RDG160KN

| | | |
|-------------------------------------|---|---|
| KNX bus | Interface type | KNX, TP1-64 (electrically isolated) |
| | Bus current | 20 mA |
| | Bus topology: See KNX manual (reference documentation, see below) | |
| Operational data | Switching differential, adjustable | |
| | Heating mode | (P30) 2 K (0.5...6 K) |
| | Cooling mode | (P31) 1 K (0.5...6 K) |
| | Setpoint setting and setpoint range | |
| | ☀ Comfort mode | (P08) 21 °C (5...40 °C) |
| | ☾ Economy | (P11-P12) 15 °C/30 °C (OFF, 5..40 °C) |
| | 🔒 Protection | (P65-P66) 8 °C/OFF (OFF, 5..40 °C) |
| | Multifunctional inputs X1 / X2 / D1 | |
| | Input X1 default value | (P38) 1 (Ext. temperature sensor, room or return air) |
| | Input X2 default value | (P40) 0 (no function) |
| | Input D1 default value | (P42) 3 (Operating mode switchover) |
| | Built-in room temperature sensor | |
| | Measuring range | 0...49 °C |
| Accuracy at 25 °C | < ± 0.5 K | |
| Temperature calibration range | ± 3.0 K | |
| Settings and display resolution | | |
| Setpoints | 0.5 °C | |
| Current temperature value displayed | 0.5 °C | |
| Environmental conditions | Operation | |
| | Climatic conditions | Class 3K5 |
| | Temperature | 0...50 °C |
| | Humidity | <95% r.h. |
| | Transport | |
| | Climatic conditions | Class 2K3 |
| | Temperature | -25...65 °C |
| | Humidity | <95% r.h. |
| | Mechanical conditions | Class 2M2 |
| | Storage | |
| | Climatic conditions | Class 1K3 |
| | Temperature | - 25...65 °C |
| | Humidity | <95% r.h. |
| Standards and directives | EU conformity (CE) | |
| | Product standards | |
| | Automatic electric controls for household and similar use | EN60730-1 |
| | Special requirements for temperature-dependent controls | EN60730-2-9 |
| | Electronic control type | 2.B (micro-disconnection on operation) |
| | Electromagnetic compatibility | 2004/108/EC |
| Emissions | EN60730-1, EN50491-5-2 | |
| Immunity | EN60730-1, EN50491-5-2 EN50491-5-3 | |

| | |
|---|-----------------------|
| Low-voltage directive | 2006/95/EC |
| Electrical safety | EN60730-1, EN50491-3 |
|  RCM Mark conformity (Emission) | AS/NZS 61000-6-3 |
|  Reduction of hazardous substances | 2011/65/EU EN50581 |
| Safety class | II as per EN60730 |
| Pollution class | Normal |
| Degree of protection of housing | IP30 as per EN60529 |

Environmental
Compatibility

The product environmental declaration CE1E3181^{*)} contains data on environmentally compatible product design and assessments (RoHS compliance, materials composition, packaging, environmental benefit, disposal).

eu.bac



Meets the requirements for eu.bac certification

See product list at: <http://www.eubaccert.eu/licences-by-criteria.asp>

| | | |
|---|-------------------------|----------------------------|
| RDG160KN (License 213356) | Energy Efficiency Label | Control accuracy [K] |
| Fancoil unit systems (2 pipes 2 wires) (Motorised actuator DC, variable fan speed) | AA | Heating 0.1 Cooling 0.1 |
| Fancoil unit systems (4 pipes) (Thermal actuator 2-pt, variable fan speed) | A | Heating 0.4 Cooling 0.4 |

General

Connection terminals

Solid wires or stranded wires with wire end sleeves
1 x 0.4...2.5 mm²
or 2 x 0.4...1.5 mm²
min 1.5 mm²

Caution 

Minimal wiring cross section on
L, N, Q1, Q2, Q3, Y1, Y2, Y3, Y4

Housing front color RAL 9003 white

| | | |
|---------------------------------|----------|---------------------|
| Weight without / with packaging | RDG100KN | 0.270 kg / 0.380 kg |
| | RDG160KN | 0.240 kg / 0.320 kg |

*) The documents can be downloaded from <http://siemens.com/bt/download>.

Reference documentation

Handbook for Home and Building Control - Basic Principles

(<http://www.knx.org/knx-en/training/books-documentation/knx-association-books/index.php>)

| | |
|--------|--|
| Synco | CE1P3127 Communication via the KNX bus for Synco 700, 900 and RXB/RXL Basic documentation |
| Desigo | CM1Y9775 Desigo RXB integration – S-mode CM1Y9776 Desigo RXB / RXL integration – individual addressing CM1Y9777 Third-party integration CM1Y9778 Synco integration CM1Y9779 Working with ETS |

Connection terminals

RDG100KN

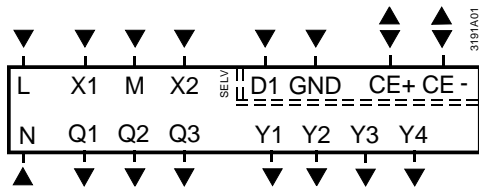

| | | |
|--------|--|--|
| L, N | Operating voltage AC 230 V | (RDG100KN) |
| G, G0 | Operating voltage AC 24 V | (RDG160KN) |
| L | Feed for relays AC 24...230 V | (RDG160KN) |
| X1, X2 | Multifunctional input for temperature sensor (e.g. QAH11.1) or potential-free switch Factory setting: – X1 = External temperature sensor – X2 = No function | (function can be selected via parameters P38 / P40). |

RDG160KN

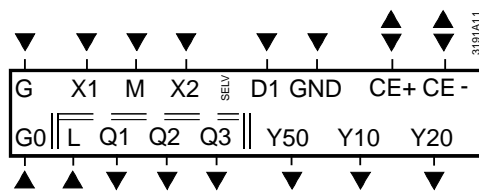

| | |
|----------|---|
| M | Measuring neutral for sensors and switches |
| D1, GND | Multifunctional input for potential-free switch Factory setting: Operating mode switchover contact (function can be selected via parameter P42). |
| Q1 | Control output fan speed "low" AC 230 V |
| Q2 | Control output fan speed "medium" AC 230 V |
| Q3 | Control output fan speed "high" AC 230 V |
| Q1...Q3 | Also for special functions AC 24...230 V (RDG160KN) |
| Y1...Y4 | Control outputs "Valve" AC 230 V (RDG100KN) ("N/O" triac, for normally closed valves), output for electric heater via external relay |
| Y10, Y20 | Control outputs "Valve" DC 0...10 V (RDG160KN) |
| Y50 | Control output "Fan" DC 0...10 V (RDG160KN) |
| CE+ | KNX data + |
| CE- | KNX data - |

Connection diagrams RDG100KN

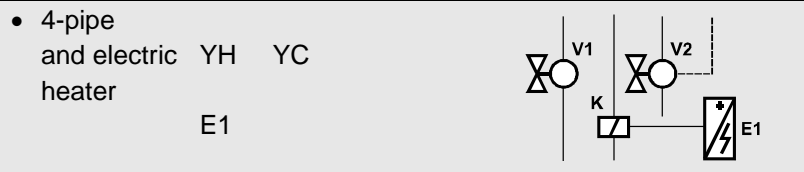
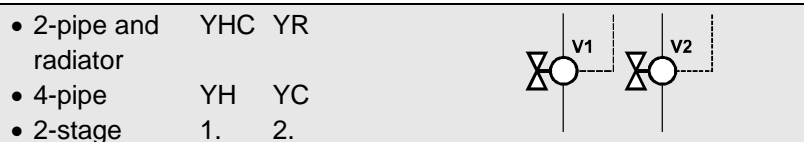
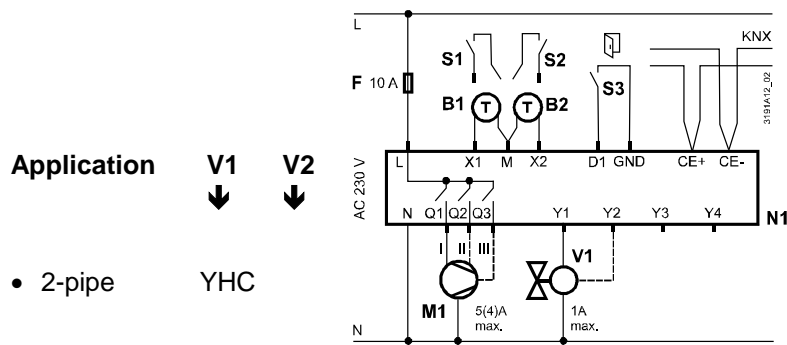

- | | | | |
|--------|---|--------|---|
| N1 | Room thermostat RDG100KN | M1 | 1- or 3-speed fan |
| F | External circuit breaker | V1, V2 | Valve actuators: On/Off or PWM, 3-position, heating, cooling, radiator, heating / cooling, 1st or 2nd stage |
| S1, S2 | Switch (keycard, window contact, presence detector, etc.) | E1 | Electric heater |
| S3 | Switch at SELV input (keycard, window contact) | K | Relay |
| B1, B2 | Temperature sensor (return air temperature, external room temperature, changeover sensor, etc.) | YH | Heating valve actuator |
| CE+ | KNX data + | YC | Cooling valve actuator |
| CE- | KNX data - | YHC | Heating / cooling valve actuator |
| | | YR | Radiator valve actuator |
| | | E1 | Electric heater with relay/contactors Y 1 st / 2 nd 1 st / 2 nd stage |

DC 0...10 V fan

1- / 3-speed fan

Application

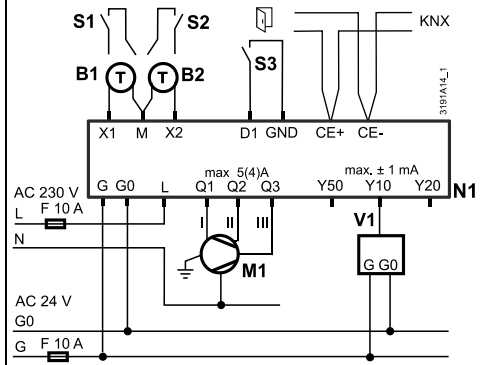
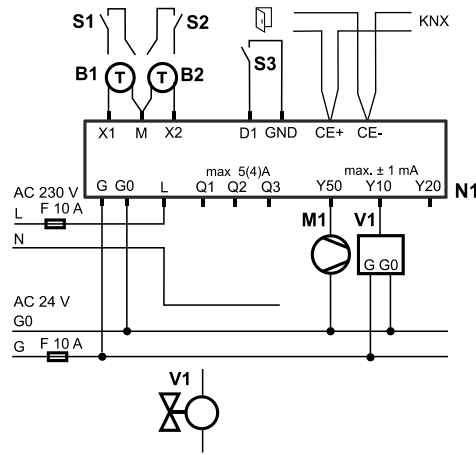
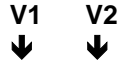

- 2-pipe YHC

- 2-pipe and radiator YHC YR
- 4-pipe YH YC
- 2-stage 1st 2nd

Q1 Q2 Y10 Y20

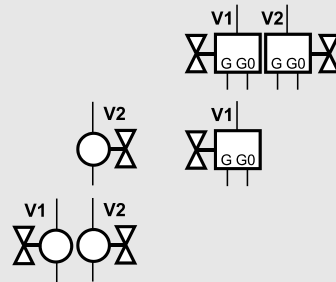

Y10 Y20

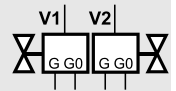

- 2-pipe and electric heater YHC E1

Q1 Q2 Y10 Y20

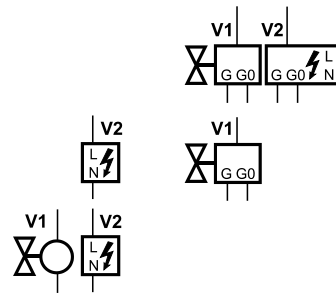

Y10 Y20

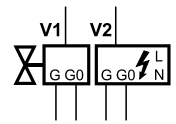

- Compressor 1st 1-stage

Q1 Q2 Y10 Y20

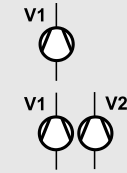

- Compressor 1st 2nd 2-stage

| | | | |
|---------|---|-----------------------------------|---|
| N1 | Room thermostat RDG160KN | M1 | 1- or 3-speed fan, DC 0...10 V fan |
| F | External circuit breaker | V1, V2 | Valve actuators: On/Off or DC 0...10 V, heating, cooling, radiator, heating / cooling, 1st or 2nd stage |
| S1...S3 | Switch (keycard, window contact, presence detector, etc.) | YH | Heating valve actuator |
| B1, B2 | Temperature sensor (return air temperature, external room temperature, changeover sensor, etc.) | YC | Cooling valve actuator |
| CE+ | KNX data + | YHC | Heating / cooling valve actuator |
| CE- | KNX data - | YR | Radiator valve actuator |
| | | 1 st / 2 nd | 1 st / 2 nd stage |

Dimensions

Dimensions in mm

