



EN Operating instructions. pages 1 to 8
Translation of the original operating instructions

6.4 Diagnostic signal periphery error. 5
6.5 Read-out of the parameter port 5

7 Set-up and maintenance
7.1 Functional testing. 6
7.2 Maintenance 6

8 Disassembly and disposal
8.1 Disassembly. 6
8.2 Disposal 6

9 Appendix
9.1 EC Declaration of conformity 7

Content

1 About this document
1.1 Function. 1
1.2 Target group: authorised qualified personnel. 1
1.3 Explanation of the symbols used 1
1.4 Appropriate use 1
1.5 General safety instructions 1
1.6 Warning about misuse 2
1.7 Exclusion of liability 2

2 Product description
2.1 Ordering code 2
2.2 Special versions. 2
2.3 Comprehensive quality insurance to 2006/42/EC 2
2.4 Destination and use 2
2.5 Technical data 2
2.6 Safety classification 3

3 Mounting
3.1 General mounting instructions 3
3.2 Dimensions 3
3.3 Switching distance 3
3.4 Adjustment. 4

4 Electrical connection
4.1 General information for electrical connection. 4

5 Functions and configuration
5.1 Programming the slave address 4
5.2 Configuration of the safety monitor 4
5.3 Status signal "safety release" 4
5.4 Actuator teaching / actuator detection 4

6 Diagnostic
6.1 LED indications 5
6.2 Error 5
6.3 Diagnostic information 5

1. About this document

1.1 Function
This operating instructions manual provides all the information you need for the mounting, set-up and commissioning to ensure the safe operation and disassembly of the safety switchgear. The operating instructions must be available in a legible condition and a complete version in the vicinity of the device.

1.2 Target group: authorised qualified personnel
All operations described in this operating instructions manual must be carried out by trained specialist personnel, authorised by the plant operator only.

Please make sure that you have read and understood these operating instructions and that you know all applicable legislations regarding occupational safety and accident prevention prior to installation and putting the component into operation.

The machine builder must carefully select the harmonised standards to be complied with as well as other technical specifications for the selection, mounting and integration of the components.

1.3 Explanation of the symbols used

 **Information, hint, note:**
This symbol is used for identifying useful additional information.

 **Caution:** Failure to comply with this warning notice could lead to failures or malfunctions.
Warning: Failure to comply with this warning notice could lead to physical injury and/or damage to the machine.

1.4 Appropriate use
The products described in these operating instructions are developed to execute safety-related functions as part of an entire plant or machine. It is the responsibility of the manufacturer of a machine or plant to ensure the correct functionality of the entire machinery or plant.

The safety switchgear must be exclusively used in accordance with the versions listed below or for the applications authorised by the manufacturer. Detailed information regarding the range of applications can be found in the chapter "Product description".

1.5 General safety instructions
The user must observe the safety instructions in this operating instructions manual, labelled with the caution or warning symbol above, the country-specific installation standards as well as all prevailing safety regulations and accident prevention rules.

 Further technical information can be found in the Schmersal catalogues or in the online catalogue on the Internet: www.schmersal.net.

The information contained in this operating instructions manual is provided without liability and is subject to technical modifications.

There are no residual risks, provided that the safety instructions as well as the instructions regarding mounting, commissioning, operation and maintenance are observed.

1.6 Warning about misuse



In case of improper use or manipulation of the safety switchgear, personal hazards or damages to machinery or plant components cannot be excluded when safety switchgear is used. The relevant requirements of the standard ISO 14119 must be observed.

1.7 Exclusion of liability

We shall accept no liability for damages and malfunctions resulting from defective mounting or failure to comply with this operating instructions manual. The manufacturer shall accept no liability for damages resulting from the use of unauthorised spare parts or accessories.

For safety reasons, invasive work on the device as well as arbitrary repairs, conversions and modifications to the device are strictly forbidden; the manufacturer shall accept no liability for damages resulting from such invasive work, arbitrary repairs, conversions and/or modifications to the device.

2. Product description

2.1 Ordering code

This operating instructions manual applies to the following types:

RSS36-①-ST-AS-②

No.	Option	Description
①		Standard coding
	AD	Standard coding, actuator detection
	I1	Individual coding
②	I2	Individual coding, re-teaching enabled without latching
	R	with latching, latching force approx. 18 N

Actuator

RST36-1	without latching
RST36-1-R	with latching, latching force approx. 18 N
RST36-1-AD01...15	without latching, with actuator detection

2.2 Special versions

For special versions, which are not listed in the order code below 2.1, these specifications apply accordingly, provided that they correspond to the standard version.

2.3 Comprehensive quality insurance to 2006/42/EC

Schmersal is a certified company to appendix X of the Machinery Directive. As a result, Schmersal is entitled to autonomously conduct the conformity assessment procedure for the products listed in Appendix IV of the MD without involving a notified body. The EC prototype test certificates are available upon request or can be downloaded from the Internet at www.schmersal.com.

2.4 Destination and use

This non-contact, electronic safety sensor is designed for application in safety circuits and is used for monitoring the position of movable safety guards. In this application, the safety sensor monitors the position of hinged, sliding or removable safety guards by means of the coded electronic actuator.

The safety function consists of safely switching off the code transmission when the safety guard is opened and maintaining the safe switched off condition for as long as the safety guard is open.



The safety switchgears are classified according to ISO 14119 as type 4 switching devices. Designs with individual coding are classified as highly coded and are labelled with "High Level Code".

An AS-Interface Safety at Work component functions on the basis of an individual code generator (8 x 4 bit). This safety code is cyclically transmitted over the AS-i network and monitored by a safety monitor.

Safety sensors and actuators with latching (ordering suffix 'R') must always be used in pairs. The latching force (approx. 18 N) exercised by the permanent magnet keeps hatches and small guards closed, also in a de-energised condition.

The system can be used as a door end stop up to 5 kg at 0.25 m/s.



The user must evaluate and design the safety chain in accordance with the relevant standards and the required safety level.

2.5 Technical data

Standards: IEC 60947-5-3, EN 50295

Working principle: RFID

Coding level according to ISO 14119:

- I1-version:	high
- I2-version:	high
- Standard coding version:	low

Material of the housings: Plastic, glass-fibre reinforced thermoplastic, self-extinguishing

Response time: < 100 ms

Duration of risk: < 200 ms

Time to readiness: ≤ 5 s

Switching frequency f: ≤ 1 Hz

Actuator: RST36-1, RST36-1-R, RST36-1-AD01...15

Mechanical data

Execution of the electrical connection: M12 connector plug, 4 poles

Mechanical life: ≥ 1 million operations

- when used as door stop: for safety guards ≤ 5 kg and actuating speed ≤ 0.25 m/s

Switching distance s_n : 12 mm

- Assured switch-on distance s_{so} : 10 mm

- Assured switch-off distance s_{so} : 16 mm

- Hysteresis: < 2.0 mm

- Repeat accuracy R: < 0.5 mm

Latching force (R): approx. 18 N

Ambient conditions

Ambient temperature: -25 °C ... +70 °C

Storage and transport temperature: -25 °C ... +85 °C

Resistance to shock: 30 g / 11 ms

Resistance to vibration: 10 ... 55 Hz, amplitude 1 mm

Protection class: IP65 / IP67 to IEC/EN 60529

IP69K to DIN 40050-9

Protection class: II

Insulation values to IEC/EN 60664-1:

- Rated impulse withstand voltage U_{imp} : 0.8 kV

- Rated insulation voltage U_i : 32 VDC

- Overvoltage category: III

- Degree of pollution: 3

Electrical data - AS-Interface

AS-i supply voltage: 18.0 ... 31.6 VDC, protection against polarity reversal

AS-i power consumption: ≤ 100 mA

AS-i device insulation: internal short-circuit proof

AS-i specification:

- Version: V 3.0

- Profile: S-0.B.F.E

AS-i inputs:

- Channel 1: Data bits DI 0/DI 1 = dynamic code transmission

- Channel 2: Data bits DI 2/DI 3 = dynamic code transmission

Databits condition static 0 or dynamic code transmission

AS-i Outputs:

- DO 0 ... DO 3: no Function

AS-i parameter bits:

- P0:	Actuator present
- P1:	Hysteresis signal (FID)g
- P2:	Tamper protection time active (FID)
- P3:	Device error (FID)

Actuator detection (AD):

- P0 ... P3:	Actuator number 0, 01 - 15
--------------	----------------------------

Parameter request: default value parameter request "1111" (0xF)

AS-i Input module address: 0

- preset to address 0, can be changed through

AS-interface bus master or hand-held programming device

LED switching conditions display:

green/red LED (AS-i Duo LED):	Supply voltage / communication error / slave address = 0 / periphery error detected / Tamper protection time active
red LED:	Internal device error
yellow LED:	Device condition (enabling status) / hysteresis signal



For use in NFPA 79 Applications only. Only for use in Pollution Degree 2 Environment. Adapters providing field wiring means are available from the manufacturer. Refer to manufacturers information.

2.6 Safety classification

Standards: ISO 13849-1, IEC 61508

PL: e

Control Category: 4

PFH value: $\leq 5.13 \times 10^{-10} / h$

PFD: $\leq 3.24 \times 10^{-5}$

SIL: suitable for SIL 3 applications

Service life: 20 years

3. Mounting

3.1 General mounting instructions



During fitting, the requirements of ISO 14119 must be observed.

The universal mounting holes provide for a variable mounting by means of M4 screws. The component can be mounted in any position. The labelled surfaces of the safety sensor and the actuator have to be opposite. The safety sensor must only be used within the assured switching distances $\leq s_{a0}$ and $\geq s_{ar}$.



The safety component and the actuator must be permanently fitted to the safety guards and protected against displacement by suitable measures (tamperproof screws, gluing, drilling, pinning).

To avoid any interference inherent to this kind of system and any reduction of the switching distances, please observe the following guidelines:

- The presence of metal chips in the vicinity of the sensor is liable to modify the switching distance.
- Keep away from metal chips.
- Minimum distance between two sensors: 100 mm

Accessories (to be ordered separately)

Sealing kit

- Ordering code 101215048
- 8 plugs and 4 washers
- to seal the mounting holes and as spacer (approx. 3 mm) to facilitate the cleaning below the mounting surface
- also suitable as tampering protection for the screw fixings.

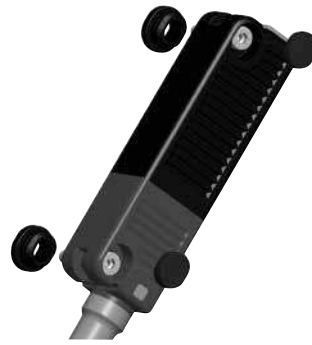

Kit tamper-proof screws

- 4 x M4x25 incl. washers, ordering code 101217746
- 4 x M4x30 incl. washers, ordering code 101217747

3.2 Dimensions

All measurements in mm.

Safety sensor RSS36-...-ST-AS

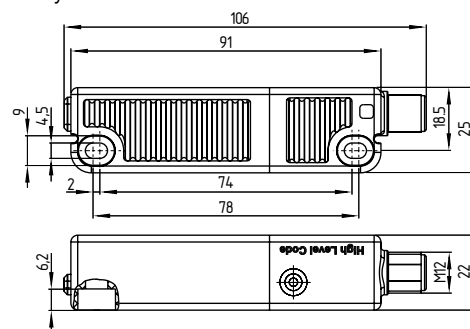

Actuator RST36-1 / RST36-1-R

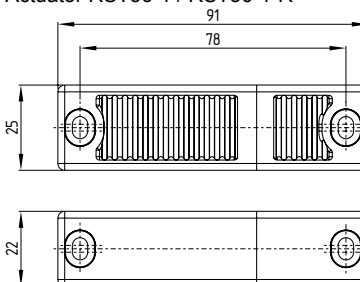

Alternative suitable actuators with different design: refer to www.schmersal.net.

3.3 Switching distance

The side allows for a maximum height misalignment (X) of sensor and actuator of ± 8 mm (e.g. mounting tolerance or due to guard door sagging). The axial misalignment (y) is max. ± 18 mm.

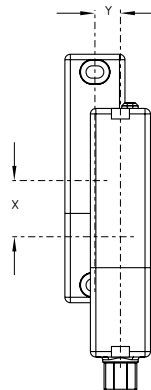

Latching versions X ± 5 mm, Y ± 3 mm. The latching force will be reduced by misalignment.

Actuating curves

The actuating curves represent the typical switching distance of the safety sensor during the approach of the actuator subject to the actuating direction

Transverse misalignment

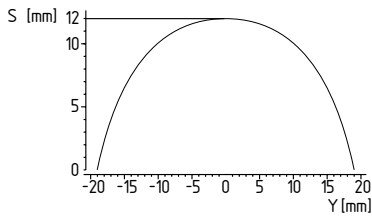

Height misalignment

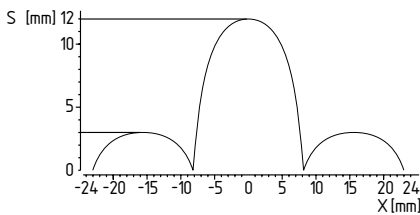

 Preferred actuation directions: from front or from side

3.4 Adjustment

The continuous signal of the yellow LED signals the actuator detection; the flashing of the yellow LED signals that the safety sensor is actuated in the hysteresis area.

 **Recommended Adjustment**
Align the safety sensor and actuator at a distance of $0.5 \times s_{a0}$.

The correct functionality of both safety channels must be checked by means of the connected safety-monitoring module.

4. Electrical connection

4.1 General information for electrical connection

 The electrical connection may only be carried out by authorised personnel in a de-energised condition.

The connection to the AS-Interface system is realised through an M12 connector. The M12 connector is A-coded. The wiring configuration of the M12 connector is determined as follows (to EN 50295):

Pin assignment M12 connector

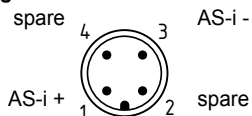

5. Functions and configuration

5.1 Programming the slave address

The slave address is programmed through the M12 connector. Any address from 1 to 31 can be set by means of the AS-i bus master or a hand-held programming device.

5.2 Configuration of the safety monitor

The RSS36 AS can be configured in the ASIMON configuration software with the following monitoring devices (also refer to the ASIMON manual). (also refer to the ASIMON manual)

Double channel dependent

- Synchronisation time: 0.1 s
- Optionally with startup test
- Optional with local acknowledge

 The configuration of the safety monitor must be tested and confirmed by a qualified and authorised safety expert/safety engineer.

5.3 Status signal "safety release"

The "safety release" status signal from a Safety at Work slave can be cyclically queried by the control system through the AS-i master. To this effect, the 4 input bits with the varying SaW code of a Safety at Work slave are evaluated through an OR operation with 4 inputs in the control system.

5.4 Actuator teaching / actuator detection

Safety sensors with standard coding are ready to use upon delivery. Individually coded safety sensors and actuators will require the following "teach-in" procedure:

1. Switch the safety sensor's voltage supply off and back on.
2. Introduce the actuator in the detection range. The teach-in procedure is signalled at the safety sensor, red LED on, yellow LED flashes (1 Hz).
3. After 10 seconds, brief cyclic flashes (3 Hz) request the switch-off of the operating voltage of the safety sensor. (If the voltage is not switched off within 5 minutes, the safety sensor cancels the "teach-in" procedure and signals a false actuator by 5 red flashes).
4. After the operating voltage is switched back on, the actuator must be detected once more in order to activate the taught actuator code. In this way, the activated code is definitively saved!

For ordering suffix -I1, the thus executed allocation of safety sensor and actuator is irreversible.

For ordering suffix -I2, the "teach-in" procedure for a new actuator can be repeated an unlimited number of times. When a new actuator is taught, the code, which was applicable until that moment, becomes invalid. Subsequent to that, an enabling inhibit will be active for ten minutes, thus providing for an increased protection against tampering. The AS-i Duo LED will flash red/green until the expiration of the time of the enabling inhibit and the detection of the new actuator. In case of power failure during the lapse of time, the 10-minutes tampering protection time will restart.

Actuator detection (AD)

Device with actuator detection (AD) can emit the number of especially coded actuators through the parameter port.

In this way, a non-safe identification of the actuator is possible.

Through the 4 bits of the parameter port, the actuators with the numbers 01 - 15 can be detected and transmitted to the control.

If no actuator is detected, a 0 will be emitted.

Safety sensors and actuators with actuator detection must always be used in pairs.

Actuator RST36-1-AD01...15, 15 different actuators at the most

6. Diagnostic

6.1 LED indications

The LED's have the following meaning (to EN 50295):

LED green-red (AS-i Duo LED):	AS-Interface supply voltage / AS-Interface communication error / Slave address = 0 / Periphery error detected / Enabling inhibit (tamper protection time) active
Red LED:	Internal device error
Yellow LED:	Device condition (enabling status) / hysteresis signal

6.3 Diagnostic information

Table 1: Diagnostic information of the RSS36 AS safety switchgear

The safety switch signals the operational state as well as errors through three coloured LED's installed on the device.

System condition	LED			Periphery error FID-Bit	Authorised operation AS-i SaW-Code (DI 0 ... DI 3)
	green-red AS-i duo-LED	red Error	yellow Status		
Safety guard open	green	Off	Off	Off	static 0
Safety guard closed	green	Off	On	Off	dynamic
Actuated in limit area	red-green flashing	Off	Flashes	Set	dynamic
Enabling inhibit (tamper protection time) active	red-green flashing	Off	Off	Set	static 0
Internal device error / periphery error	red-green flashing	Flashes ¹⁾	Off	Set	static 0
AS-i error: slave address = 0 or communication error	red	depending on the condition		Off	static 0

1) refer to flash code

Table 2: Error messages / flash codes red LED

Flash codes (red)	Designation	Autonomous switch-off after	Error cause
4 flash pulses	Ambient temperature high	0 min	Ambient temperature too high: T > 70 °C
5 flash pulses	Actuator fault	0 min	Incorrect or defective actuator
Continuous red signal	Internal error	0 min	Device defective

6.4 Diagnostic signal periphery error

All error messages of the safety switchgear are also transmitted as a "periphery error" to the control system through the AS-i master. A "periphery error" (FID input of the AS-i chip) is signaled by the alternating red and green flashing of the AS-i duo LED on the AS-i device.

6.5 Read-out of the parameter port

The parameter port P0 to P3 of an AS-i slave can be read out through the control interface of the AS-i master (see component description) by means of the "Write parameter" instruction (with hexadecimal value F). This (non-safe) diagnostic information from the reflected parameters or the answer to a "Write parameter instruction" can be used by the user for diagnostic purposes or for the control programme.

6.2 Error

Errors, which no longer guarantee the safe functionality of the RSS36 AS electromagnetic interlock, cause the safety outputs to be switched off and are signaled through a flashing pattern of the red LED. (see table 2)

After fault rectification, the error message can be reset by opening and closing the relevant guard door. The safety outputs of the safety monitor can be switched back on, thus enabling the machine.

Diagnostic information (P0 ... P3)

Parameter bit	Condition = 1
0	Actuator in
1	Hysteresis signal (FID)
2	Enabling inhibit (tamper protection time) active (FID)
3	Error detected (FID)

Actuator detection (AD) P0 ... P3

Parameter bit	Condition = 1
0 ... 3	Binary number actuator 01 - 15 0 = no actuator detected

7. Set-up and maintenance

7.1 Functional testing

The safety function of the safety components must be tested. The following conditions must be previously checked and met:

1. Fitting of the sensor and the actuator.
2. Fitting and integrity of the power cable.
3. The system is free of dirt and soiling (in particular metal chips).

7.2 Maintenance

In the case of correct installation and adequate use, the safety switchgear features maintenance-free functionality.

A regular visual inspection and functional test, including the following steps, is recommended:

1. Check the safety function
2. Check the fixing and integrity of the safety switchgear, the actuator and the cable
3. Remove possible metal chips.



Measures must be taken to protect against manipulation or against the bypassing of safety device, for example, using an extra actuator

Damaged or defective components must be replaced.

8. Disassembly and disposal

8.1 Disassembly

The safety switchgear must be disassembled in a de-energised condition only.

8.2 Disposal

The safety switchgear must be disposed of in an appropriate manner in accordance with the national prescriptions and legislations.

9. Appendix

9.1 EC Declaration of conformity

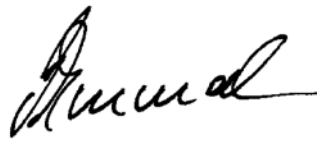
	
<h2>EC Declaration of conformity</h2>	
Translation of the original Declaration of Conformity	K.A. Schmersal GmbH & Co. KG Möddinghofe 30 42279 Wuppertal Germany Internet: www.schmersal.com
<p>We hereby certify that the hereafter described safety components both in its basic design and construction conform to the applicable European Directives.</p>	
Name of the safety component:	RSS36 AS
Type:	See ordering code
Description of the safety component:	Non-contact safety sensor with integrated AS-i Safety at Work
Relevant EC-Directives:	2006/42/EC EC-Machinery Directive 2004/108/EC EMC-Directive 1999/5/EC R&TTE-Directive
Person authorised for the compilation of the technical documentation:	Oliver Wacker Möddinghofe 30 42279 Wuppertal
Notified body, which approved the full quality assurance system, referred to in Appendix X, 2006/42/EC:	TÜV Rheinland Industrie Service GmbH Alboinstr. 56 12103 Berlin ID n°: 0035
Place and date of issue:	Wuppertal, October 23, 2015
RSS36AS-B-EN	
	Authorised signature Philip Schmersal Managing Director



The currently valid declaration of conformity can be downloaded from the internet at www.schmersal.net.



K.A. Schmersal GmbH & Co. KG
Möddinghofe 30, D - 42279 Wuppertal
Postfach 24 02 63, D - 42232 Wuppertal

Phone: +49 - (0)2 02 - 64 74 - 0
Telefax: +49 - (0)2 02 - 64 74 - 1 00
E-Mail: info@schmersal.com
Internet: <http://www.schmersal.com>