



EN Operating instructions.pages 1 to 8
Translation of the original operating instructions

6 Diagnostic
6.1 LED indications6
6.2 Error.6
6.3 Diagnostic information6
6.4 Diagnostic signal periphery error6
6.5 Read-out of the parameter port6

7 Set-up and maintenance
7.1 Functional testing.7
7.2 Maintenance7

8 Disassembly and disposal
8.1 Disassembly.7
8.2 Disposal7

9 Appendix
9.1 EC Declaration of conformity8

Content

1 About this document
1.1 Function1
1.2 Target group: authorised qualified personnel.1
1.3 Explanation of the symbols used1
1.4 Appropriate use1
1.5 General safety instructions1
1.6 Warning about misuse2
1.7 Exclusion of liability2

2 Product description
2.1 Ordering code2
2.2 Special versions.2
2.3 Comprehensive quality insurance to 2006/42/EC2
2.4 Destination and use2
2.5 Technical data2
2.6 Safety classification3

3 Mounting
3.1 General mounting instructions3
3.2 Dimensions3
3.3 Actuating directions4
3.4 Switching distance4
3.5 Adjustment.4

4 Electrical connection
4.1 General information for electrical connection.5

5 Functions and configuration
5.1 Programming the slave address5
5.2 Configuration of the safety monitor5
5.3 Status signal "safety release"5
5.4 Actuator teaching / actuator detection5

1. About this document

1.1 Function

This operating instructions manual provides all the information you need for the mounting, set-up and commissioning to ensure the safe operation and disassembly of the safety switchgear. The operating instructions must be available in a legible condition and a complete version in the vicinity of the device.

1.2 Target group: authorised qualified personnel

All operations described in this operating instructions manual must be carried out by trained specialist personnel, authorised by the plant operator only.

Please make sure that you have read and understood these operating instructions and that you know all applicable legislations regarding occupational safety and accident prevention prior to installation and putting the component into operation.

The machine builder must carefully select the harmonised standards to be complied with as well as other technical specifications for the selection, mounting and integration of the components.

1.3 Explanation of the symbols used



Information, hint, note:

This symbol is used for identifying useful additional information.



Caution: Failure to comply with this warning notice could lead to failures or malfunctions.

Warning: Failure to comply with this warning notice could lead to physical injury and/or damage to the machine.

1.4 Appropriate use

The products described in these operating instructions are developed to execute safety-related functions as part of an entire plant or machine. It is the responsibility of the manufacturer of a machine or plant to ensure the correct functionality of the entire machinery or plant.

The safety switchgear must be exclusively used in accordance with the versions listed below or for the applications authorised by the manufacturer. Detailed information regarding the range of applications can be found in the chapter "Product description".

1.5 General safety instructions

The user must observe the safety instructions in this operating instructions manual, labelled with the caution or warning symbol above, the country-specific installation standards as well as all prevailing safety regulations and accident prevention rules.



Further technical information can be found in the Schmersal catalogues or in the online catalogue on the Internet: www.schmersal.net.

The information contained in this operating instructions manual is provided without liability and is subject to technical modifications.

There are no residual risks, provided that the safety instructions as well as the instructions regarding mounting, commissioning, operation and maintenance are observed.

1.6 Warning about misuse



In case of improper use or manipulation of the safety switchgear, personal hazards or damages to machinery or plant components cannot be excluded when safety switchgear is used. The relevant requirements of the standard ISO 14119 must be observed.

1.7 Exclusion of liability

We shall accept no liability for damages and malfunctions resulting from defective mounting or failure to comply with this operating instructions manual. The manufacturer shall accept no liability for damages resulting from the use of unauthorised spare parts or accessories.

For safety reasons, invasive work on the device as well as arbitrary repairs, conversions and modifications to the device are strictly forbidden; the manufacturer shall accept no liability for damages resulting from such invasive work, arbitrary repairs, conversions and/or modifications to the device.

2. Product description

2.1 Ordering code

This operating instructions manual applies to the following types:

RSS260-①-ST-AS

No.	Option	Beschreibung
①		Standard coding
	I1	Individual coding
	I2	Individual coding, re-teaching enabled
	AD	Standard coding with actuator detection

Actuator

RST260-1	Standard actuator
RST260-1-AD01...15	Variant with actuator detection

2.2 Special versions

For special versions, which are not listed in the order code below 2.1, these specifications apply accordingly, provided that they correspond to the standard version.

2.3 Comprehensive quality insurance to 2006/42/EC

Schmersal is a certified company to appendix X of the Machinery Directive. As a result, Schmersal is entitled to autonomously conduct the conformity assessment procedure for the products listed in Appendix IV of the MD without involving a notified body. The EC prototype test certificates are available upon request or can be downloaded from the Internet at www.schmersal.com.

2.4 Destination and use

This non-contact, electronic safety sensor is designed for application in safety circuits and is used for monitoring the position of movable safety guards. In this application, the safety sensor monitors the position of hinged, sliding or removable safety guards by means of the coded electronic actuator.



The safety function consists of safely switching off the code transmission when the safety guard is opened and maintaining the safe switched off condition for as long as the safety guard is open.

An AS-Interface Safety at Work component functions on the basis of an individual code generator (8 x 4 bit). This safety code is cyclically transmitted over the AS-i network and monitored by a safety monitor.



The user must evaluate and design the safety chain in accordance with the relevant standards and the required safety level.

2.5 Technical data

Standards:	EN 50295, ISO 14119, IEC 61508, ISO 13849-1
Working principle:	RFID
Coding levels according to ISO 14119:	
- variant I1:	high
- variant I2:	high
Enclosure material:	Thermoplastic hot melt, Macromelt 6208S
Response time:	≤ 140 ms
Duration of risk:	≤ 200 ms
Time to readiness:	≤ 6 s
Switching frequency f:	≤ 1 Hz
Actuator:	RST260-1, RST260-1-AD01...15
Connection:	Connector plug M8, 4-pole, A-coded
Switching distances to IEC 60947-5-3:	
Typical switching distance:	12 mm;
- in case of lateral actuation:	9 mm
Assured switch on distance s_{ao} :	10 mm;
- with side approach:	6 mm
Assured switch-off distance s_{ar} :	18 mm;
- in case of lateral actuation:	15 mm
Hysteresis:	< 2.0 mm
Repeat accuracy R:	< 0.5 mm
Ambient conditions	
Ambient temperature:	-25 °C ... +60 °C
Storage and transport temperature:	-25 °C ... +85 °C
Resistance to shock:	30 g / 11 ms
Resistance to vibration:	10 ... 55 Hz, amplitude 1 mm
Protection class:	IP65 / IP67 to IEC 60529
Protection class:	III
Insulation values to IEC/EN 60664-1:	
- Rated impulse withstand voltage U_{imp} :	0.8 kV
- Rated insulation voltage U_i :	32 VDC
- Overvoltage category:	III
- Degree of pollution:	3
Electrical data - AS-Interface	
AS-i supply voltage:	18.0 ... 31.6 VDC, protection against polarity reversal
AS-i power consumption:	≤ 100 mA
AS-i device insulation:	internal short-circuit proof
AS-i specification:	
- Version:	V 3.0
- Profile:	S-0.B.F.E
AS-i inputs:	
- Channel 1:	Data bits DI 0/DI 1 = dynamic code transmission
- Channel 2:	Data bits DI 2/DI 3 = dynamic code transmission
	Databits condition static 0 or dynamic code transmission
AS-i Outputs:	
- DO 0 ... DO 3:	no Function
AS-i parameter bits:	
- P0:	Actuator present
- P1:	Hysteresis signal (FID)g
- P2:	Tamper protection time active (FID)
- P3:	Device error (FID)
Actuator detection (AD):	
- P0 ... P3:	Actuator number 0, 01 - 15
Parameter request:	default value parameter request "1111" (0xF)
AS-i Input module address:	0
	- preset to address 0, can be changed through AS-interface bus master or hand-held programming device

LED switching conditions display:

green/red LED (AS-i Duo LED):

Supply voltage /
communication error /
slave address = 0 /
periphery error detected /
Tamper protection time active

yellow LED:

device condition (enabling status) /
hysteresis signal / device error



For use in NFPA 79 Applications only.

Adapters providing field wiring means are available from the manufacturer. Refer to manufacturer's information.

2.6 Safety classification

Standards:	ISO 13849-1, IEC 61508
PL:	e
Control Category:	4
PFH value:	$\leq 3.93 \times 10^{-10} / h$
PFD:	$\leq 6.89 \times 10^{-5}$
SIL:	suitable for SIL 3 applications
Service life:	20 years

3. Mounting

3.1 General mounting instructions



During fitting, the requirements of ISO 14119 must be observed.

The mounting holes provide for a variable mounting by means of M4 screws (max. tightening torque 0.8 Nm). The component can be mounted in any position. The labelled surfaces of the safety sensor and the actuator have to be opposite. The safety sensor must only be used within the assured switching distances $\leq s_{ao}$ and $\geq s_{ar}$.



Safety sensor and actuator must be permanently fitted to the safety guards and protected against displacement by suitable measures (tamperproof screws, gluing, drilling of the screw heads).

To avoid any interference inherent to this kind of system and any reduction of the switching distances, please observe the following guidelines:

- The presence of metal chips in the vicinity of the sensor is liable to modify the switching distance.
- Keep away from metal chips.
- Minimum distance between two sensors: 100 mm

Accessories (to be ordered separately)

Kit tamper-proof screws

- 4 x M4x20 incl. washers, ordering code 103006158
- 4 x M4x25 incl. washers, ordering code 101217746

Sealing kit

- Ordering code **103004733**
- Plugs: 4 flat pieces for flush finish and 4 round pieces for high screw heads to seal the installation holes
- Flush one-way plugs for flat screw heads, also suitable as tampering protection for the screw fixings

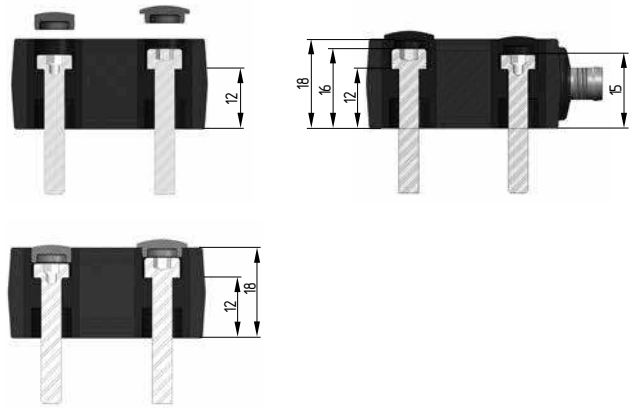

Mounting set

- Ordering code 103005469
- Alternative use of the mounting plates or ferrules
- Mounting plates: 2 pieces for mounting on non-linear stable basis, e.g. on groove rails/profiles
- Ferrules: 4 pieces for insertion to secure the screw fixings to the mounting surface for applications with regular high temperature variations



3.2 Dimensions

All measurements in mm.

Safety sensor RSS260-AS

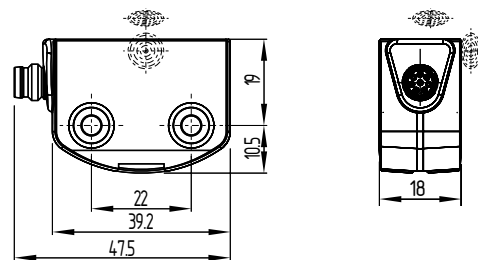

Actuator RST260-1 / RST260-1-AD01 ... 15

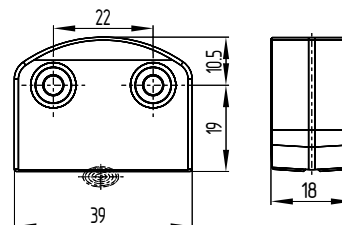

Alternative suitable actuators with different design: refer to www.schmersal.net.

3.3 Actuating directions

Actuation from front

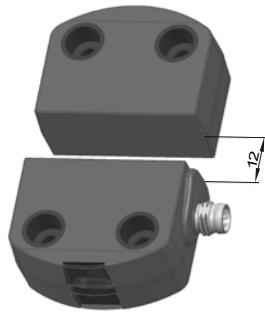

Actuation from side

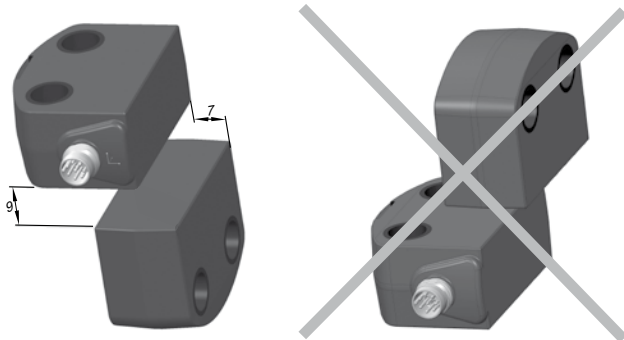

Lateral actuation only from the shown sensor side

3.4 Switching distance

The side allows for a maximum height misalignment (X) of sensor and actuator of ± 8 mm (e.g. mounting tolerance or due to guard door sagging). The axial misalignment (y) is max. ± 18 mm.

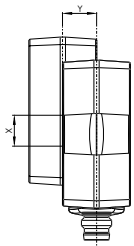

Actuating curves

The actuating curves represent the typical switching distance of the safety sensor during the approach of the actuator subject to the actuating direction

Transverse misalignment

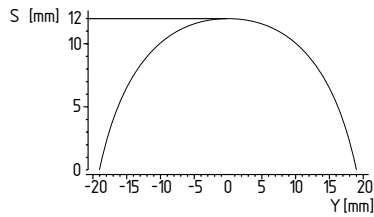

Height misalignment

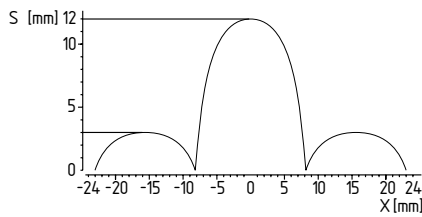

Preferred actuation directions: from front or from side
In case of a lateral actuation, the switching distances are reduced by approx. 3 mm.

3.5 Adjustment

The continuous signal of the yellow LED signals the actuator detection; the flashing of the yellow LED after a delay signals that the safety sensor is actuated in the hysteresis area.



Recommended Adjustment

Align the safety sensor and actuator at a distance of $0.5 \times s_{a0}$.

The correct functionality of both safety channels must be checked by means of the connected safety-monitoring module.

4. Electrical connection

4.1 General information for electrical connection



The electrical connection may only be carried out by authorised personnel in a de-energised condition.

The connection to the AS-Interface system is realised through an M8 connector. The M8 connector is A-coded.

The connection to the M12-plug is made (according to EN 50295) to the AS-Interface systems with an adapter cable of M8 / 4-pin (socket) on to M12 / 4-pin (plug):

Pin assignment M8 / M12 connector

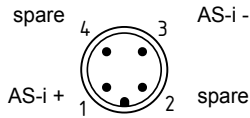

Connector adapter cables (available as accessories)

IP67, M8-coupling to M12-connector, 4-pin

Cable length	Ordering code
1 m	103003648
2 m	103003649
3 m	103003651

5. Functions and configuration

5.1 Programming the slave address

The slave address is programmed through the M8 connector. Any address from 1 to 31 can be set by means of the AS-i bus master or a hand-held programming device.

5.2 Configuration of the safety monitor

The RSS260 AS can be configured in the ASIMON configuration software with the following monitoring devices (also refer to the ASIMON manual)

Double channel dependent

- Synchronisation time: 0.1 s
- Optionally with startup test
- Optional with local acknowledge



The configuration of the safety monitor must be tested and confirmed by a qualified and authorised safety expert/safety engineer.

5.3 Status signal "safety release"

The "safety release" status signal from a Safety at Work slave can be cyclically queried by the control system through the AS-i master. To this effect, the 4 input bits with the varying SaW code of a Safety at Work slave are evaluated through an OR operation with 4 inputs in the control system.

5.4 Actuator teaching / actuator detection

Safety sensors with standard coding are ready to use upon delivery. Individually coded safety sensors and actuators will require the following "teach-in" procedure:

1. Switch the safety sensor's voltage supply off and back on.
2. Introduce the actuator in the detection range. The teach-in procedure is signalled at the safety sensor, yellow LED flashes (1 Hz).
3. After 10 seconds, brief cyclic flashes (3 Hz) request the switch-off of the operating voltage of the safety sensor. (If the voltage is not switched off within 5 minutes, the safety sensor cancels the "teach-in" procedure and signals a false actuator by 5 yellow flashes.)
4. After the operating voltage is switched back on, the actuator must be detected once more in order to activate the taught actuator code. In this way, the activated code is definitively saved!

For ordering suffix -I1, the thus executed allocation of safety sensor and actuator is irreversible.

For ordering suffix -I2, the "teach-in" procedure for a new actuator can be repeated an unlimited number of times. When a new actuator is taught, the code, which was applicable until that moment, becomes invalid. Subsequent to that, an enabling inhibit will be active for ten minutes, thus providing for an increased protection against tampering. The AS-i Duo LED will flash red/green until the expiration of the time of the enabling-inhibit and the detection of the new actuator. In case of power failure during the lapse of time, the 10-minutes tampering protection time will restart.

Actuator detection (AD)

Device with actuator detection (AD) can emit the number of especially coded actuators through the parameter port.

In this way, a non-safe identification of the actuator is possible.

Through the 4 bits of the parameter port, the actuators with the numbers 01 - 15 can be detected and transmitted to the control.

If no actuator is detected, a 0 will be emitted.

Safety sensors and actuators with actuator detection must always be used in pairs.

Actuator RST260-1-AD01...15, 15 different actuators at the most

6. Diagnostic

6.1 LED indications

The LED's have the following meaning (to EN 50295):

LED green-red (AS-i Duo LED):	AS-Interface supply voltage / AS-Interface communication error / Slave address = 0 / Periphery error detected / Enabling inhibit (tamper protection time) active
Yellow LED:	Device status (enabling status) / hysteresis signal / device error

6.3 Diagnostic information

Table 1: Diagnostic information of the RSS260 AS safety switchgear

The safety switch signals the operational state as well as errors through three coloured LED's installed on the device.

System condition	LED		Periphery error FID-Bit	Authorised operation AS-i SaW-Code (DI 0 ... DI 3)
	green-red AS-i duo-LED	yellow Status		
Safety guard open	green	Off	0	static 0
Guard door closed	green	on	0	dynamically (authorised operation)
Actuated in limit area	red-green flashing	Flashes	1	dynamically (authorised operation)
Enabling inhibit (tamper protection time) active	red-green flashing	Off	1	static 0
Internal device error / periphery error	red-green flashing	Off	1	static 0
AS-i error: slave address = 0 or communication error	red	depending on the condition	Off	static 0

1) refer to flash code

Table 2: Error messages / flash codes yellow LED

Flash codes (yellow)	Designation	Autonomous switch-off after	Error cause
4 flash pulses	Ambient temperature high	0 min	Ambient temperature too high: T > 60 °C
5 flash pulses	Actuator fault	0 min	incorrect or defective actuator
yellow permanent light	Internal error	0 min	Device defective

6.4 Diagnostic signal periphery error

All error messages of the safety switchgear are also transmitted as a "periphery error" to the control system through the AS-i master. A "periphery error" (FID input of the AS-i chip) is signaled by the alternating red and green flashing of the AS-i duo LED on the AS-i device.

6.5 Read-out of the parameter port

The parameter port P0 to P3 of an AS-i slave can be read out through the control interface of the AS-i master (see component description) by means of the "Write parameter" instruction (with hexadecimal value F). This (non-safe) diagnostic information from the reflected parameters or the answer to a "Write parameter instruction" can be used by the user for diagnostic purposes or for the control programme.

6.2 Error

Errors, which no longer guarantee the safe functionality of the RSS260 AS electromagnetic interlock, cause the safety outputs to be switched off and are signaled through a flashing pattern of the red LED. (see table 2).

After fault rectification, the error message can be reset by opening and closing the relevant guard door. The safety outputs of the safety monitor can be switched back on, thus enabling the machine.

Diagnostic information (P0 ... P3)

Parameter bit	Condition = 1
0	Actuator in
1	Hysteresis signal (FID)
2	Enabling inhibit (tamper protection time) active (FID)
3	Internal device error detected (FID)

Variant with actuator detection (AD) P0 - P3

Parameter bit	Condition = 1
0 ... 3	Binary number actuator 01 - 15 0 = no actuator detected

7. Set-up and maintenance

7.1 Functional testing

The safety function of the safety components must be tested. The following conditions must be previously checked and met:

1. Fitting of the sensor and the actuator.
2. Fitting and integrity of the power cable.
3. The system is free of dirt and soiling (in particular metal chips).

7.2 Maintenance

In the case of correct installation and adequate use, the safety switchgear features maintenance-free functionality.

A regular visual inspection and functional test, including the following steps, is recommended:

1. Check the safety function
2. Check the fixing and integrity of the safety switchgear, the actuator and the cable
3. Remove possible metal chips.



Measures must be taken to protect against manipulation or against the bypassing of safety device, for example, using an extra actuator

Damaged or defective components must be replaced.

8. Disassembly and disposal

8.1 Disassembly

The safety switchgear must be disassembled in a de-energised condition only.

8.2 Disposal

The safety switchgear must be disposed of in an appropriate manner in accordance with the national prescriptions and legislations.

9.1 EC Declaration of conformity

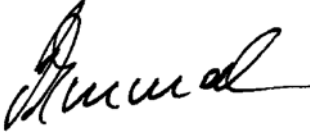
	
EC Declaration of conformity	
Translation of the original Declaration of Conformity	K.A. Schmersal GmbH & Co. KG Mödinghofe 30, 42279 Wuppertal Germany Internet: www.schmersal.com
We hereby certify that the hereafter described safety components both in its basic design and construction conform to the applicable European Directives.	
Name of the safety component:	RSS260 AS
Type:	See ordering code
Description of the safety component:	Non-contact safety sensor with integrated AS-i Safety at Work
Relevant EC-Directives:	2006/42/EC EC-Machinery Directive 2004/108/EC EMC-Directive 1999/5/EC R&TTE-Directive
Person authorized for the compilation of the technical documentation:	Oliver Wacker Mödinghofe 30 42279 Wuppertal
Notified body, which approved the full quality assurance system, referred to in Appendix X, 2006/42/EC:	TÜV Rheinland Industrie Service GmbH Alboinstr. 56 12103 Berlin ID n°: 0035
Place and date of issue:	Wuppertal, January 6, 2015
RSS260-ASA-EN	
	Authorised signature Philip Schmersal Managing Director



The currently valid declaration of conformity can be downloaded from the internet at www.schmersal.net.



K.A. Schmersal GmbH & Co. KG
Mödinghofe 30, D - 42279 Wuppertal
Postfach 24 02 63, D - 42232 Wuppertal

Phone: +49 - (0)2 02 - 64 74 - 0
Telefax: +49 - (0)2 02 - 64 74 - 1 00
E-Mail: info@schmersal.com
Internet: <http://www.schmersal.com>