



EN Operating instructions..... pages 1 to 6
Translation of the original operating instructions

FR Vous trouverez la version actuelle du mode d'emploi dans votre langue nationale officielle sur l'Internet, www.schmersal.net.

ES Encontrará el manual de instrucciones actual en su idioma oficial de la UE en nuestra página de Internet www.schmersal.net.

NL U vindt de huidige versie van de gebruikshandleiding in uw officiële landstaal op het Internet, www.schmersal.net.

IT Il manuale d'istruzioni aggiornato nella vostra lingua (lingua ufficiale UE) è scaricabile in Internet all'indirizzo www.schmersal.net.

JP EU公用語で書かれた最新の取扱説明書は、インターネット(www.schmersal.net)からダウンロードできます。

Content

1 About this document	
1.1 Function	1
1.2 Target group: authorised qualified personnel	1
1.3 Explanation of the symbols used	1
1.4 Appropriate use	1
1.5 General safety instructions	1
1.6 Warning about misuse	1
1.7 Exclusion of liability	2
2 Product description	
2.1 Ordering code	2
2.2 Special versions	2
2.3 Destination and use	2
2.4 Technical data	2
2.5 Safety classification	2
3 Mounting	
3.1 Dimensions	3
3.2 Mounting of the position switches	3
3.3 Changing the switching function (4VH, 4V7H, 4V10H)	3
3.4 Mounting of the actuating heads	3
3.5 Actuation of the position switches	4
4 Electrical connection	
4.1 General information for electrical connection	4
5 Configuration	
5.1 Programming the slave address	4
5.2 Configuration of the safety monitor	4
5.3 Status signal "safety release"	4
6 Set-up and maintenance	
6.1 Functional testing	4
6.2 Maintenance	4
7 Disassembly and disposal	
7.1 Disassembly	4
7.2 Disposal	4
8 Appendix	
8.1 EC Declaration of conformity	5

1 About this document

1.1 Function

This operating instructions manual provides all the information you need for the mounting, set-up and commissioning to ensure the safe operation and disassembly of the safety switchgear. The operating instructions must be available in a legible condition and a complete version in the vicinity of the device.

1.2 Target group: authorised qualified personnel

All operations described in this operating instructions manual must be carried out by trained specialist personnel, authorised by the plant operator only.

Please make sure that you have read and understood these operating instructions and that you know all applicable legislations regarding occupational safety and accident prevention prior to installation and putting the component into operation.

The machine builder must carefully select the harmonised standards to be complied with as well as other technical specifications for the selection, mounting and integration of the components.

1.3 Explanation of the symbols used



Information, hint, note:

This symbol is used for identifying useful additional information.



Caution: Failure to comply with this warning notice could lead to failures or malfunctions.

Warning: Failure to comply with this warning notice could lead to physical injury and/or damage to the machine.

1.4 Appropriate use

The products described in these operating instructions are developed to execute safety-related functions as part of an entire plant or machine. It is the responsibility of the manufacturer of a machine or plant to ensure the proper functionality of the entire machinery or plant.

The safety switchgear must be exclusively used in accordance with the versions listed below or for the applications authorised by the manufacturer. Detailed information regarding the range of applications can be found in the chapter "Product description".

1.5 General safety instructions

The user must observe the safety instructions in this operating instructions manual, the country-specific installation standards as well as all prevailing safety regulations and accident prevention rules.



Further technical information can be found in the Schmersal catalogues or in the online catalogue on the Internet: www.schmersal.net.

The information contained in this operating instructions manual is provided without liability. Subject to technical modifications.

There are no residual risks, provided that the safety instructions as well as the instructions regarding mounting, commissioning, operation and maintenance are observed.

1.6 Warning about misuse



In case of inadequate or improper use or manipulations of the safety switchgear, personal hazards or damage to machinery or plant components cannot be excluded. The relevant requirements of the standard EN 1088 must be observed.

1.7 Exclusion of liability

We shall accept no liability for damages and malfunctions resulting from defective mounting or failure to comply with this operating instructions manual. The manufacturer shall accept no liability for damages resulting from the use of unauthorised spare parts or accessories.

For safety reasons, invasive work on the device as well as arbitrary repairs, conversions and modifications to the device are strictly forbidden; the manufacturer shall accept no liability for damages resulting from such invasive work, arbitrary repairs, conversions and/or modifications to the device.

2 Product description

2.1 Ordering code

This operating instructions manual applies to the following types:

T①335 AS-ST		
No.	Option	Description
①		Actuator selection: refer to main catalogue "Safety Technology"

 Only if the information described in this operating instructions manual are realised correctly, the safety function and therefore the compliance with the Machinery Directive is maintained.

2.2 Special versions

For special versions, which are not listed in the order code below 2.1, these specifications apply accordingly, provided that they correspond to the standard version.

2.3 Destination and use

The T..335-AS safety switch is suitable for sliding or hinged doors, which need to be closed in order to provide for the required operational safety. The combination of the safety switch T..335-AS and the ASM AS-i safety monitor safely monitors the condition of the corresponding safety guard.

An AS-Interface Safety at Work component functions on the basis of an individual code generator (8 x 4 bit). This safety code is cyclically transmitted over the AS-i network and monitored by the ASM safety monitor.

The safety function of the T..335-AS consists in safely switching off the code transmission when the safety guard is opened and maintaining the safe switched-off condition for as long as the safety guard is open.

The component status can be evaluated through a PLC with AS-Interface master. The safety-related functions are enabled by means of the AS-i safety monitor.

 The user must evaluate and design the safety chain in accordance with the relevant standards and the required safety level.

LED indication

The LED's have the following meaning (to EN 50295):

- LED green: AS-Interface supply voltage
- LED red: AS-Interface communication error or slave address = 0
- LED yellow: Enabling status

2.4 Technical data

Standards:	EN 50295, EN 60947-5-1, EN ISO 13849-1, IEC 61508
Design:	Fixings to EN 50041
Enclosure:	Zinc die-cast, enamel finish
Switching system:	Slow action, positive break NC contact ⊖
Mechanical life:	> 1 million operations
Switching frequency	max. 5000/h
Max. actuating speed:	1 m/s
Protection class:	IP 67 to IEC/EN 60529
Insulation protection class:	II
Overvoltage category:	III
Degree of pollution:	3
Termination:	M12 connector, 4 pole
Electrical data AS-Interface:	
Operating voltage range:	26.5 ... 31.6 VDC, through AS-Interface, reverse polarity-proof
AS-interface power consumption:	max. 0.1 A
Rated insulation voltage U _{i1} :	32 VDC
Rated impulse withstand voltage U _{imp1} :	800 V
Device fuse rating:	internally short-circuit proof
Specification (V 2.1):	AS-i slave profile: S-0 .B.E IO code: 0 x 0 ID code 0 x B ID code 1: 0 x F ID code 2: 0 x E
AS-i inputs:	
Contact 1:	Data bits D0 / D1 = static 00 or dynamic code transmission
Contact 2:	Data bits D2 / D3 = static 00 or dynamic code transmission
Outputs:	A0 ... A3 no function
Parameter bits:	P0 ... P3 no function
Diagnostic information:	
Green LED:	AS-Interface supply voltage
Red LED:	AS-Interface communication error or slave address = 0
Yellow LED:	Enabling status
Input module address:	preset to address 0, can be changed through AS-interface bus master or hand-held programming device
Ambient conditions:	
EMC rating:	conforming to EMC Directive
Ambient temperature:	-25 °C ... +60 °C
Storage and transport temperature:	-25 °C ... +85 °C

2.5 Safety classification (Approval under preparation)

Standards:	EN ISO 13849-1, IEC 61508
PL:	up to c
Control category:	up to 1
PFH value:	1.14 x 10 ⁻⁶ /h up to max. 1,000,000 switching cycles/year
SIL:	up to 1
Service life:	20 years
If 2 safety switches with mutual monitoring are used and provided that sufficient protection against tampering is provided, suitable up to:	
PL:	up to e
Control category:	up to 4
PFH value:	2.5 x 10 ⁻⁸ /h up to max. 1,000,000 switching cycles/year
SIL:	up to 3
Service life:	20 years

3 Mounting

3.1 Dimensions

All measurements in mm.

Dimensions T 335-AS

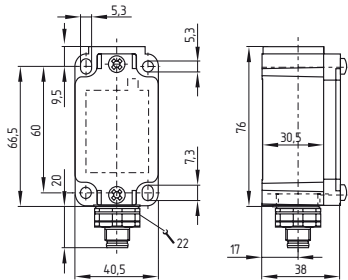

3.2 Mounting of the position switches

The mounting dimensions are mentioned at the rear of the enclosure. The fixing screws of the component must be protected against unauthorised tampering. The switch enclosure must not be used as end stop. Any mounting position. To ensure a proper functioning, the switch must be installed so that the required switch travel is obtained. For safety functions, at least the positive break travel indicated in the switch travel diagram (refer to catalogue) must be obtained. All components have sufficient after-travel to compensate for inaccuracies in the guidance of the actuating system. The actuation of the switch beyond its end stop however must be avoided.



Please observe the remarks of the standards EN ISO 12100, EN 953 and EN 1088.

3.3 Changing the switching function (4VH, 4V7H, 4V10H)

Position switches with "4V" actuating head can be set so that they are switched either only clockwise, only counterclockwise or in both directions. The following steps are required.

1. Unscrew the screws and remove the actuating head.
2. Change the position of both inner plastic parts.
3. Replace the actuating head and tighten the screws

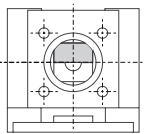

switching in both directions

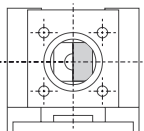

switching only clockwise

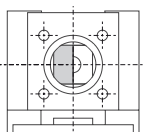

switching only counterclockwise

3.4 Mounting of the actuating heads

Repositioning the actuating head (R, K, 1K, 3K, V, 4V.H)

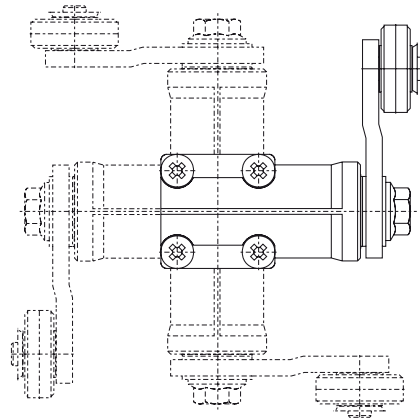

The actuating head can be repositioned by 4 x 90°. Unscrew the four screws of the actuating head. Reposition the actuating head in the desired position and retighten the four screws.

Repositioning the roller lever (H)

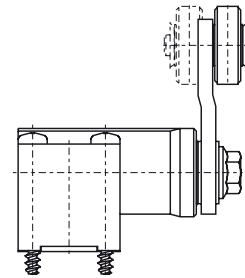

The roller lever can be repositioned by 180°, so that the roller either faces towards or away from the switch.

Positioning the lever (.H)

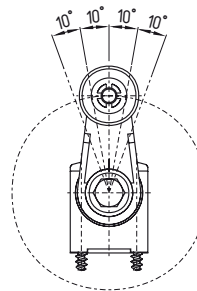

The roller lever can be repositioned in 10° steps over 360° on the toothed shaft. Unscrew the hexagonal screw for approx. 4 mm, position the lever in the desired position and retighten the screw.

Length-adjustable lever (7H-2138)

To adjust the length of the lever, unscrew the fixing screw of the lever. Firmly retighten the screw after the length adjustment.

3.5 Actuation of the position switches

Top plunger

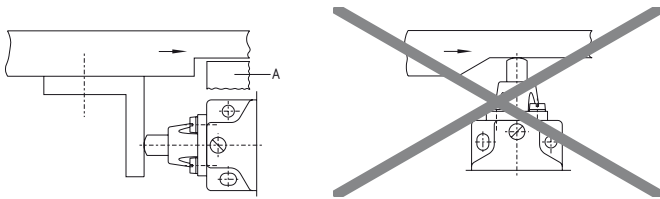

A Stop

Roller plunger

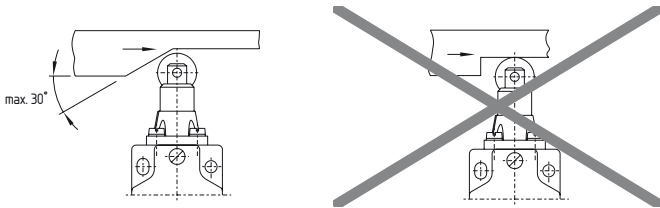

Cam disc

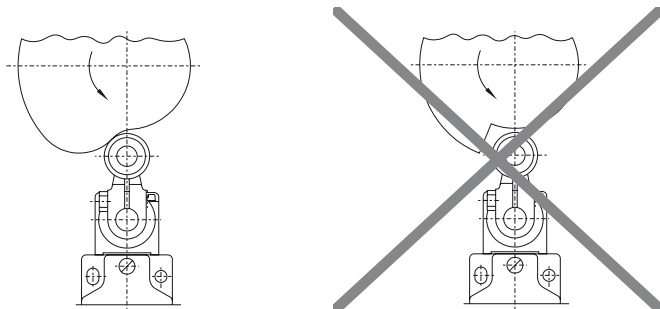

Front side

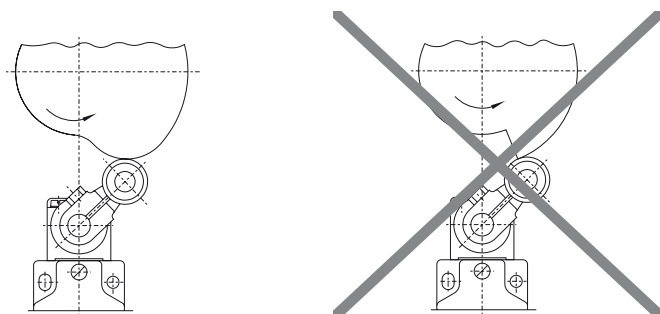

Rear side

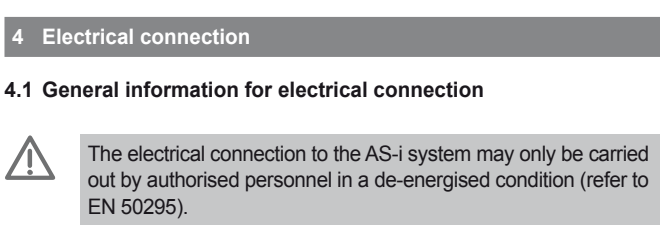

4 Electrical connection

4.1 General information for electrical connection



The electrical connection to the AS-i system may only be carried out by authorised personnel in a de-energised condition (refer to EN 50295).

The connection to the AS-Interface system is realised through an M12 connector. The M12 x 1 connector is A-coded. The wiring configuration of the M12 connector is defined as follows (to EN 50295):

- 1: AS-i +
- 2: spare
- 3: AS-i -
- 4: spare
- 5: FE (functional earth connection)



For safe ESD protection of the integrated electronics, the metal enclosure of the switch must be equipped with a reliable earth connection. This can be realised either through pin 5 of the M12 connector or through the fixing screws for the switch. If the fixing screws are used for the earth connection, a good contact between the metal enclosure of the switch (use toothed washers!) and the earthed mounting surface must be ensured.

5 Configuration

5.1 Programming the slave address

The slave address is programmed through the M12 connector. Any address from 1 to 31 can be set by means of the AS-i bus master or a hand-held programming device.

5.2 Configuration of the safety monitor

In the ASIMON configuration software, the T..335-AS can be configured with the following safety-monitoring modules (refer to ASIMON manual):

Dual-channel dependent

- Optional with start-up test
- Synchronisation time typically 0.5 – 2.0 s

Dual-channel dependent with filtering

The use of this safety-monitoring module is especially advantageous on safety guards where bounce or vibration against the mechanical stop upon closing is a problem.

- Optional with start-up test
- Stabilising time typically 0.5 1.0 s
- Synchronisation time typically 5.0 – 10.0 s

The safety-monitoring module is only released after expiration of the stabilising time; the synchronization time always must exceed the stabilising time.



The configuration of the safety monitor must be tested and confirmed by a qualified and authorised safety expert/safety engineer.

5.3 Status signal "safety release"

The "safety release" status signal from a Safety at Work slave can be cyclically queried by the control system through the AS-i master. To that effect, the 4 input bits with the varying SaW code of a Safety at Work slave are evaluated through an OR operation with 4 inputs in the control system.

6 Set-up and maintenance

6.1 Functional testing

The safety function of the safety components must be tested. The following conditions must be previously checked and met:

1. Check the switch enclosure for damage.
2. Check the free movement of the actuating element
3. Check the integrity of the cable entry and connections

6.2 Maintenance

A regular visual inspection and functional test, including the following steps, is recommended:

1. Check the free movement of the actuating element
2. Remove particles of dust and soiling
- 3 Check cable entry and connections

Damaged or defective components must be replaced.

7 Disassembly and disposal



7.1 Disassembly

The safety switchgear must be disassembled in a de-energised condition only.

7.2 Disposal

The safety switchgear must be disposed of in an appropriate manner in accordance with the national prescriptions and legislations.

8.1 EC Declaration of conformity

	
<h2>EC Declaration of conformity</h2>	
Translation of the original declaration of conformity valid as of December 29, 2009	K.A. Schmersal GmbH Industrielle Sicherheitssysteme Mödinghofe 30, D - 42279 Wuppertal Germany Internet: www.schmersal.com
We hereby certify that the hereafter described safety components both in its basic design and construction conforms to the applicable European Directives.	
Name of the safety component / type:	T.. 335-AS
Description of the safety component:	Positive break position switch for safety functions with integrated AS-i Safety at Work
Harmonised EC-Directives:	2006/42/EC EC-Machinery Directive 2004/108/EC EMC-Directive
Person authorized for the compilation of the technical documentation:	Ulrich Loss Mödinghofe 30 42279 Wuppertal
Place and date of issue:	Wuppertal, December 2, 2009
T 335-AS-B-DE	
	Authorised signature Heinz Schmersal Managing Director



Note

The currently valid declaration of conformity can be downloaded from the internet at www.schmersal.net.



K. A. Schmersal GmbH
Industrielle Sicherheitssysteme
Möddinghofe 30, D - 42279 Wuppertal
Postfach 24 02 63, D - 42232 Wuppertal

Telefon +49 - (0)2 02 - 64 74 - 0
Telefax +49 - (0)2 02 - 64 74 - 1 00
E-Mail: info@schmersal.com
Internet: <http://www.schmersal.com>