



**EN** Operating instructions. . . . .pages 1 to 6  
Translation of the original operating instructions

**Content**

**1 About this document**

1.1 Function . . . . . 1

1.2 Target group: authorised qualified personnel. . . . . 1

1.3 Explanation of the symbols used . . . . . 1

1.4 Appropriate use . . . . . 1

1.5 General safety instructions . . . . . 1

1.6 Warning about misuse . . . . . 2

1.7 Exclusion of liability . . . . . 2

**2 Product description**

2.1 Ordering code . . . . . 2

2.2 Special versions. . . . . 2

2.3 Destination and use . . . . . 2

2.4 Technical data . . . . . 2

2.5 Safety classification . . . . . 3

**3 Mounting**

3.1 General mounting instructions . . . . . 3

3.2 Dimensions . . . . . 4

**4 Electrical connection**

4.1 General information for electrical connection. . . . . 4

**5 Functions and configuration**

5.1 Programming the slave address . . . . . 4

5.2 Configuration of the safety monitor . . . . . 4

5.3 Status signal "safety release" . . . . . 4

**6 Diagnostic**

6.1 Internal LED indications . . . . . 4

6.2 Read-out of the parameter ports . . . . . 4

**7 Set-up and maintenance**

7.1 Functional testing. . . . . 5

7.2 Maintenance . . . . . 5

**8 Disassembly and disposal**

8.1 Disassembly. . . . . 5

8.2 Disposal . . . . . 5

**9 Appendix**

9.1 EC Declaration of conformity . . . . . 6

**1. About this document**

**1.1 Function**

This operating instructions manual provides all the information you need for the mounting, set-up and commissioning to ensure the safe operation and disassembly of the safety switchgear. The operating instructions must be available in a legible condition and a complete version in the vicinity of the device.

**1.2 Target group: authorised qualified personnel**

All operations described in this operating instructions manual must be carried out by trained specialist personnel, authorised by the plant operator only.

Please make sure that you have read and understood these operating instructions and that you know all applicable legislations regarding occupational safety and accident prevention prior to installation and putting the component into operation.

The machine builder must carefully select the harmonised standards to be complied with as well as other technical specifications for the selection, mounting and integration of the components.

**1.3 Explanation of the symbols used**



**Information, hint, note:**

This symbol is used for identifying useful additional information.



**Caution:** Failure to comply with this warning notice could lead to failures or malfunctions.

**Warning:** Failure to comply with this warning notice could lead to physical injury and/or damage to the machine.

**1.4 Appropriate use**

The products described in these operating instructions are developed to execute safety-related functions as part of an entire plant or machine. It is the responsibility of the manufacturer of a machine or plant to ensure the correct functionality of the entire machinery or plant.

The safety switchgear must be exclusively used in accordance with the versions listed below or for the applications authorised by the manufacturer. Detailed information regarding the range of applications can be found in the chapter "Product description".

**1.5 General safety instructions**

The user must observe the safety instructions in this operating instructions manual, the country-specific installation standards as well as all prevailing safety regulations and accident prevention rules.



Further technical information can be found in the Schmersal catalogues or in the online catalogue on the Internet: [www.schmersal.net](http://www.schmersal.net).

The information contained in this operating instructions manual is provided without liability and is subject to technical modifications.

There are no residual risks, provided that the safety instructions as well as the instructions regarding mounting, commissioning, operation and maintenance are observed.

### 1.6 Warning about misuse



In case of improper use or manipulation of the safety switch-gear, personal hazards or damages to machinery or plant components cannot be excluded. The relevant requirements of the standard EN ISO 13850 must be observed.

### 1.7 Exclusion of liability

We shall accept no liability for damages and malfunctions resulting from defective mounting or failure to comply with this operating instructions manual. The manufacturer shall accept no liability for damages resulting from the use of unauthorised spare parts or accessories.

For safety reasons, invasive work on the device as well as arbitrary repairs, conversions and modifications to the device are strictly forbidden; the manufacturer shall accept no liability for damages resulting from such invasive work, arbitrary repairs, conversions and/or modifications to the device.

## 2. Product description

### 2.1 Ordering code

This operating instructions manual applies to the following types:

#### ZQ 900 ①-AS ②

No.	Option	Description
①	ST	Connector plug M 12, bottom
	STR	Connector plug M 12, right
	STL	Connector plug M 12, left
	FK	Flat cable connection, bottom
	FKR	Flat cable connection, at the right-hand side
	FKL	Flat cable connection, at the left-hand side
②		Without emergency-stop button
	N	With emergency-stop button



Only if the information described in this operating instructions manual are realised correctly, the safety function and therefore the compliance with the Machinery Directive is maintained.

### 2.2 Special versions

For special versions, which are not listed in the order code below 2.1, these specifications apply accordingly, provided that they correspond to the standard version.

### 2.3 Destination and use

Pull-wire emergency stop switches are used on machinery and plants, where triggering the emergency stop command must be enabled at arbitrary points on the wire run. If the tensioned pull-wire is pulled or in case of wire breakage or if the optional emergency stop switch is pushed, the switching function of the pull-wire emergency stop switch is activated. (refer to image 1).

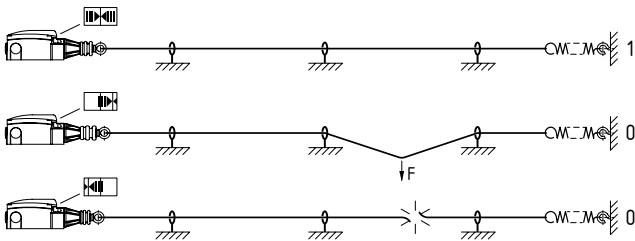

Image 1: position indication and actuation

### Design/operating principle

The pull-wire emergency stop switches are brought into the operational condition by the proper pre-tensioning of the wire. The inner switching elements have 2 contacts; in tensioned condition, the NC contacts are closed.

After actuation of the emergency stop function, a latching mechanism maintains the stop command until the switch is released by pushing the blue reset button. Prior to the reset of the emergency stop signal, the reason why the switch has been actuated must be determined. The switch can only be reset if the switch is correctly pre-tensioned (position indication in central position, refer to image 1).

An AS-Interface Safety at Work component functions on the basis of an individual code generator (8 × 4 bit). This safety code is cyclically transmitted over the AS-i network and monitored by the ASM safety monitor. The component status can be evaluated through a PLC with AS-Interface master. The safety-related functions are enabled by means of the AS-i safety monitor.



The user must evaluate and design the safety chain in accordance with the relevant standards and the required safety level.

### 2.4 Technical data

Standards: EN 60947-5-1, EN 60947-5-5, EN ISO 13850, EN 50295, EN ISO 13849-1, IEC 61508

Enclosure: zinc die-cast, enamel finish  
Cover: glass-fibre reinforced thermoplastic, self-extinguishing

Wire length: max. 75 m depending in relation to the range of ambient temperature (see image 3)

Switching system: Snap action, positive break NC ⊖

Mechanical life: ≥ 100.000 operations

Switching frequency: max. 1/s

Response time: < 100 ms

Connection: Connector plug M12, 5-pole or FK

#### Electrical data - AS-Interface:

AS-i supply voltage: 18.0 ... 31.6 VDC through AS-Interface, reverse polarity proof (stabilised PELV unit)

AS-I power consumption: ≤ 0,05 A

AS-i Device insulation: internal short-circuit proof

#### AS-I specification:

Version: V 3.0

Profile: S-0.B.F.F

IO-Code: 0×0

ID-Code: 0×B

ID-Code 1: 0×F

ID-Code 2: 0×F

#### AS-interface inputs:

Channel 1: DI 0 / DI 1 = dynamic code transmission

Channel 2: DI 2 / DI 3 = dynamic code transmission

#### AS-interface outputs:

DO 0 ... DO 3: no function

#### AS-Interface parameter port:

P0: Channel 2 switched

P1 ... P3: no function

Input module address: 0, preset to address 0, can be changed through AS-interface bus master or hand-held programming device

#### LED switching conditions display (internal)

LED yellow: Channel 1, SaW-Bit 0.1

LED green-red (AS-i Duo LED): AS-Interface supply voltage / AS-Interface communication error / slave address = 0 or periphery error detected

LED yellow: Channel 2, SaW-Bit 2.3

### Ambient conditions:

Protection class:	IP65, IP67
Ambient temperature:	-25 °C ... +60 °C
Storage and transport temperature:	-25 °C ... +85 °C
Relative humidity:	30% ... 95%, no condensation, no icing
Resistance to vibration:	10 ... 150 Hz (0,35 mm / 5 g)
Resistance to shock:	15 g / 11 ms
Protection class:	II
Overvoltage category:	III
Degree of pollution:	3
Rated impulse withstand voltage $U_{imp}$ :	800 V
Rated insulation voltage $U_i$ :	32 VDC

### 2.5 Safety classification

Standards:	EN ISO 13849-1, IEC 61508
PL:	up to e
Control category:	up to 4
PFH-value:	$\leq 1.4 \times 10^{-8}/h$ up to max. 5,000 switching cycles/year
SIL:	up to 3
Service life:	20 years

## 3. Mounting

### 3.1 General mounting instructions

The installation may only be carried out by authorised personnel. The pull-wire emergency stop switch is fitted by means of two screws (distance of the drill holes 40 mm or 48 mm), so that a release by hand can be realised without hazard. The component must be fitted so that the entire length of the wire can be viewed from the position of the switch.

In accordance with IEC/EN 60947-5-5, the maximum perpendicular traction force to be exercised on the wire in order to activate the emergency pull-wire switch is 200 N, the maximum deflection is 400 mm. Sufficient space must be provided so that the required actuating deflection can be reached.

For tensioned span lengths up to 10 m, intermediate wire supports are required every 3 to 5 m. To avoid resonance vibrations in the wire on machines with high vibrations, it is recommended to realise the individual support length differently. Assembly: refer to image 2.

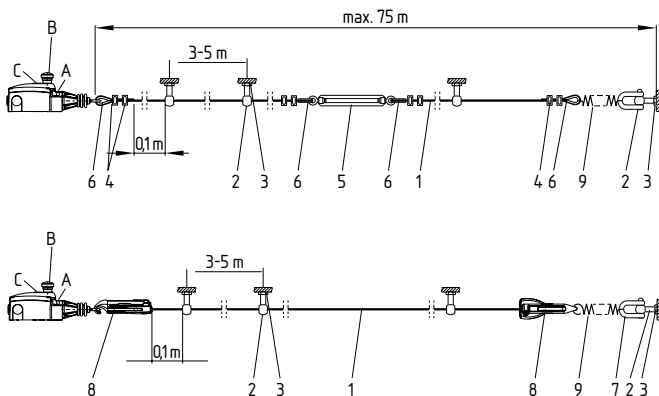

Image 2: mounting of the components

### Key

- 1 Pull-wire with red PVC sheath  $\varnothing$  5 mm (steel core:  $\varnothing$  3 mm)
- 2 Eyebolt
- 3 Nut
- 4 Wire clamp
- 5 Tensioner
- 6 Wire thimble
- 7 Shackles
- 8 S900 wire tensioner
- 9 Tension spring RZ-2041
- A Position indication
- B Emergency-Stop button
- C Reset button

We recommend the use of the RZ-2041 tension spring to attenuate the effects of temperature variations.

Due to the thermal expansion behaviour of the wire, the maximum authorised wire length is determined by the ambient temperature range (refer to image 3).

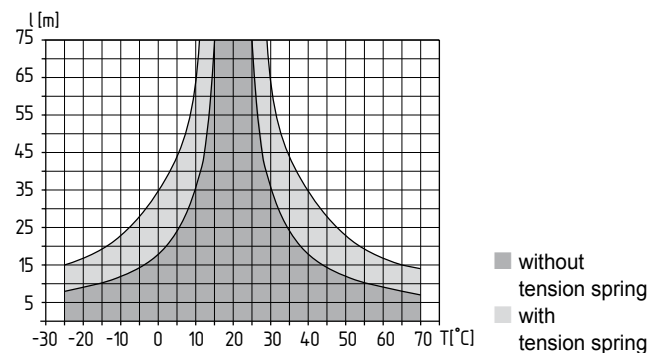

Image 3: temperature-dependent maximum wire length with or without tension spring

The pull-wire must be fixed to the ring and then be pre-tensioned until the position indication is in the central position (refer to image 1). As the thimbles are subject to deformation in case of wire pull, the wire should be pulled several times after fitting. After that, the wire must be re-tensioned (see image 4).

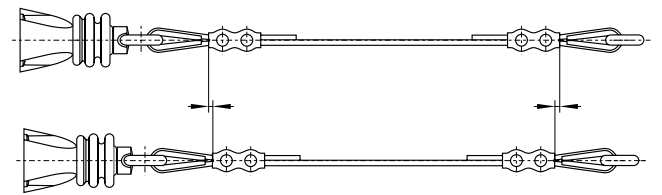

Image 4: deformation of the wire thimbles



In order to ensure an optimal operation safety and to save time during fitting, we recommend using the wire rope and the combined fixing and tensioning system from Schmersal. Alternatively, wire thimbles and wire clamps can be used in conjunction with a tensioner. In this case, the red PVC sheet must be removed in the clamp area prior to installing the wire rope.

### 3.2 Dimensions

All measurements in mm.

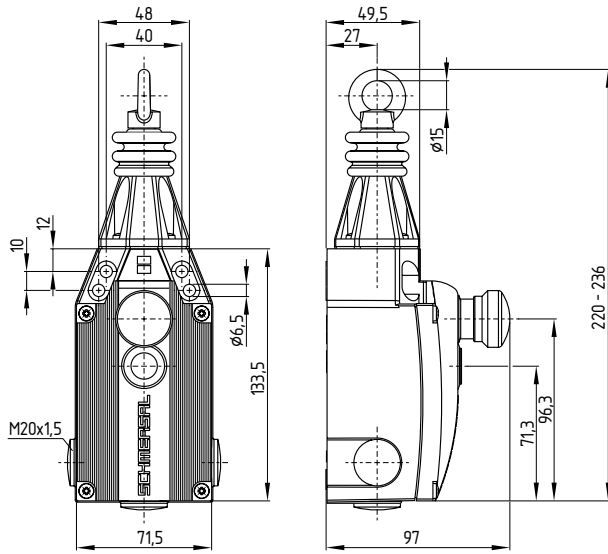

#### Key

- A Position indication
- B Emergency-Stop button
- C Reset button

### 4. Electrical connection

#### 4.1 General information for electrical connection



The electrical connection may only be carried out by authorised personnel in a de-energised condition.

The connection to the AS-Interface system is realised through an M12 connector or an AS-i flat cable clamp. The wiring configuration of the M12 connector is defined as follows (to EN 50295):

#### Pin assignment M12 connector

##### 5-pole



- PIN 1: AS-i +
- PIN 2: spare
- PIN 3: AS-i -
- PIN 4: spare
- PIN 5: FE (functional earth connection)

### 5. Functions and configuration

#### 5.1 Programming the slave address

The slave address is programmed through the AS-i connector. Any address from 1 to 31 can be set by means of the AS-i bus master or a hand-held programming device.

#### 5.2 Configuration of the safety monitor

The safety switch can be configured in the ASIMON configuration software with the following monitoring devices (refer to ASIMON manual):

##### Double channel dependent

- Optionally with startup test
- Synchronisation time typically 0.1 - 0.5 s



The configuration of the safety monitor must be tested and confirmed by a qualified and authorised safety expert/safety engineer.

#### 5.3 Status signal "safety release"

The "safety release" status signal from a Safety at Work slave can be cyclically queried by the control system through the AS-i master. To this effect, the 4 input bits with the varying SaW code of a Safety at Work slave are evaluated through an OR operation with 4 inputs in the control system.

### 6. Diagnostic

#### 6.1 Internal LED indications

The LED's have the following meaning (to EN 50295):

- LED yellow** Channel 1 / AS-i SaW-Bit 0,1
- LED green/red** AS-Interface supply voltage/ (AS-i duo LED): AS-Interface communication error or slave address = 0 or periphery error
- LED yellow** Channel 2 / AS-i SaW-Bit 2,3

#### 6.2 Read-out of the parameter ports

The parameter port P0 to P3 of an AS-i slave can be read out through the control interface of the AS-i master (see component description) by means of the "Write parameter" instruction (with hexadecimal value F). This (non-safe) diagnostic information from the reflected parameters or the answer to a "Write parameter instruction" can be used by the user for diagnostic purposes or for the control programme.

Table 3: diagnostic information (P0 ... P3)

Parameter bit	Condition = 1	Condition = 0
0	Channel 2 activated	Channel 2 disabled
1	—	—
2	—	—
3	—	—

### 7. Set-up and maintenance

#### 7.1 Functional testing

The safety function of the safety components must be tested. The following conditions must be previously checked and met:

1. Check the correct fitting of the pull-wire emergency stop switch.
2. Check the integrity of the cable entry and connections.
3. Check the switch enclosure for damage.
4. Check the functionality of the switch by actuating the wire.
5. Check the cable tensioning by means of the position indicator.

#### 7.2 Maintenance

A regular visual inspection and functional test, including the following steps, is recommended:

1. Check the functionality of the switch by actuating the wire and, if applicable, the emergency stop switch.
2. Check the cable entries and the wire connections.
3. Remove particles of dust and soiling.
4. Check the wire tension through the wire position indication and check the wire and the wire guides for damages and proper fitting.

**Damaged or defective components must be replaced.**

### 8. Disassembly and disposal

#### 8.1 Disassembly

The safety switchgear must be disassembled in a de-energised condition only.

#### 8.2 Disposal

The safety switchgear must be disposed of in an appropriate manner in accordance with the national prescriptions and legislations.

9.1 EC Declaration of conformity

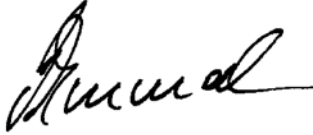
	
<b>EC Declaration of conformity</b>	
Translation of the original Declaration of Conformity	K.A. Schmersal GmbH & Co. KG Möddinghofe 30 42279 Wuppertal Germany www.schmersal.com
We hereby certify that the hereafter described safety components both in its basic design and construction conform to the applicable European Directives.	
<b>Name of the safety component:</b>	ZQ 900 AS
<b>Type:</b>	Refer to ordering code
<b>Description of the safety component:</b>	Pull-wire emergency stop switches with integrated AS-i Safety at Work
<b>Relevant EC-Directives:</b>	2006/42/EC - EC-Machinery Directive 2004/108/EC - EMC-Directive
<b>Person authorized for the compilation of the technical documentation:</b>	Oliver Wacker Möddinghofe 30 42279 Wuppertal
<b>Place and date of issue:</b>	Wuppertal, September 9, 2014
ZQ900 AS-B-EN	
	Authorised signature <b>Philip Schmersal</b> Managing Director



The currently valid declaration of conformity can be downloaded from the internet at [www.schmersal.net](http://www.schmersal.net).



**K. A. Schmersal GmbH & Co. KG**  
Möddinghofe 30, D - 42279 Wuppertal  
Postfach 24 02 63, D - 42232 Wuppertal

Phone: +49 - (0)2 02 - 64 74 - 0  
Telefax: +49 - (0)2 02 - 64 74 - 1 00  
E-Mail: [info@schmersal.com](mailto:info@schmersal.com)  
Internet: <http://www.schmersal.com>