



EN Operating instructions.pages 1 to 6
Translation of the original operating instructions

Content

1 About this document

1.1 Function 1

1.2 Target group: authorised qualified personnel. 1

1.3 Explanation of the symbols used 1

1.4 Appropriate use 1

1.5 General safety instructions 1

1.6 Warning about misuse 2

1.7 Exclusion of liability 2

2 Product description

2.1 Ordering code 2

2.2 Special versions. 2

2.3 Destination and use 2

2.4 Technical data 2

2.5 Safety classification 3

3 Mounting

3.1 General mounting instructions 3

3.2 Dimensions 3

4 Electrical connection

4.1 General information for electrical connection. 3

5 Operating principle and settings

5.1 LED functions. 3

5.2 Description of the terminals 3

5.3 Notes 4

5.4 Application hints. 4

6 Set-up and maintenance

6.1 Functional testing. 4

6.2 Maintenance 4

7 Disassembly and disposal

7.1 Disassembly. 5

7.2 Disposal 5

8 Appendix

8.1 Wiring example 5

9 Declaration of conformity

9.1 EC Declaration of conformity 6

1. About this document

1.1 Function

This operating instructions manual provides all the information you need for the mounting, set-up and commissioning to ensure the safe operation and disassembly of the safety switchgear. The operating instructions must be available in a legible condition and a complete version in the vicinity of the device.

1.2 Target group: authorised qualified personnel

All operations described in this operating instructions manual must be carried out by trained specialist personnel, authorised by the plant operator only.

Please make sure that you have read and understood these operating instructions and that you know all applicable legislations regarding occupational safety and accident prevention prior to installation and putting the component into operation.

The machine builder must carefully select the harmonised standards to be complied with as well as other technical specifications for the selection, mounting and integration of the components.

1.3 Explanation of the symbols used



Information, hint, note:

This symbol is used for identifying useful additional information.



Caution: Failure to comply with this warning notice could lead to failures or malfunctions.

Warning: Failure to comply with this warning notice could lead to physical injury and/or damage to the machine.

1.4 Appropriate use

The products described in these operating instructions are developed to execute safety-related functions as part of an entire plant or machine. It is the responsibility of the manufacturer of a machine or plant to ensure the correct functionality of the entire machinery or plant.

The safety switchgear must be exclusively used in accordance with the versions listed below or for the applications authorised by the manufacturer. Detailed information regarding the range of applications can be found in the chapter "Product description".

1.5 General safety instructions

The user must observe the safety instructions in this operating instructions manual, the country-specific installation standards as well as all prevailing safety regulations and accident prevention rules.



Further technical information can be found in the Schmersal catalogues or in the online catalogue on the Internet: www.schmersal.net.

The information contained in this operating instructions manual is provided without liability and is subject to technical modifications.



The entire concept of the control system, in which the safety component is integrated, must be validated to EN ISO 13849-2.

There are no residual risks, provided that the safety instructions as well as the instructions regarding mounting, commissioning, operation and maintenance are observed.

1.6 Warning about misuse



In case of improper use or manipulation of the safety switch-gear, personal hazards or damages to machinery or plant components cannot be excluded. The relevant requirements of the standards EN 1088 and EN ISO 13850 must be observed.

1.7 Exclusion of liability

We shall accept no liability for damages and malfunctions resulting from defective mounting or failure to comply with this operating instructions manual. The manufacturer shall accept no liability for damages resulting from the use of unauthorised spare parts or accessories.

For safety reasons, invasive work on the device as well as arbitrary repairs, conversions and modifications to the device are strictly forbidden; the manufacturer shall accept no liability for damages resulting from such invasive work, arbitrary repairs, conversions and/or modifications to the device.

The safety-monitoring module must only be used when the enclosure is closed, i.e. with the front cover fitted.

2. Product description

2.1 Ordering code

This operating instructions manual applies to the following types:

AZR 31S1 ① ②

No.	Option	Description
①	230VAC	230 VAC
	115VAC	115 VAC
	24VAC	24 VAC
	24 VDC	24 VDC
②		Pull-in delay 7 sec.
	2 sec.	Pull-in delay 2 sec.



This device is designed as dual-channel fail-safe standstill monitor for monitoring the sensorless motor standstill (no adjustment required). The nominal motor voltage may amount up to 400 VAC ±10%.



Only if the information described in this operating instructions manual are realised correctly, the safety function and therefore the compliance with the Machinery Directive is maintained.

2.2 Special versions

For special versions, which are not listed in the order code below 2.1, these specifications apply accordingly, provided that they correspond to the standard version.

2.3 Destination and use

The safety-monitoring modules for integration in safety circuits are designed for fitting in control cabinets. They are used for the safe evaluation of the voltage at the inputs L1, L2 and L3

The safety function is defined as the opening of the enabling contacts 13-14, 23-24 and 33-34 when voltage is detected at the inputs L1, L2 and L3. The safety-relevant current paths with the output contacts 13-14, 23-24 and 33-34 meet the following requirements under observation of a B_{10d} value assessment (also refer to "Requirements to DIN EN ISO 13849-1"):

- control category 4 – PL e to DIN EN ISO 13849-1
- corresponds to SIL 3 to DIN EN 61508-2
- corresponds to SILCL 3 to DIN EN 62061
(corresponds to control category 4 to DIN EN 954-1)

To determine the Performance Level (PL) of the entire safety function (e.g. sensor, logic, actuator) to DIN EN ISO 13849-1, an analysis of all relevant components is required.

2.4 Technical data

General data

Standards:	IEC / EN 60204-1, EN 60947-5-1; EN ISO 13849-1, IEC / EN 61508
Climate resistance:	EN 60068-2-78
Mounting:	Snaps onto standard DIN rail to EN 60715
Terminal designations:	EN 60947-1
Material of the housings:	glass-fibre reinforced thermoplastic, ventilated
Material of the contacts:	AgSnO, self-cleaning, positive drive
Weight:	115/230 V-version: typ. 400 g 24 V-version: typ. 380 g
Start conditions:	Automatic
Feedback circuit (Y/N):	yes
Pull-in delay:	typ. 7 sec. after the detection of the standstill (2 sec. variants: after typ. 2 sec.)
Drop-out delay:	immediately after the detection of a rotary movement < 15 ms

Mechanical data

Connection type:	Screw connection
Cable section:	min. 0.25 mm ² / max. 2.5 mm ²
Connecting cable:	rigid or flexible
Tightening torque for the terminals:	0.6 Nm
With removable terminals (Y/N):	Nein
Mechanical life:	10 million operations
Electrical life:	Derating curve available on request
Resistance to shock:	10 g / 11 ms
Resistance to vibrations to EN 60068-2-6:	10 ... 55 Hz, amplitude 0.35 mm

Ambient conditions

Ambient temperature:	–25 °C ... +45 °C
Storage and transport temperature:	–40 °C ... +85 °C
Protection class:	Enclosure: IP40 Terminals: IP20 Clearance: IP54

Air clearances and creepage distances

to IEC/EN 60664-1:	4 kV/2 (basic insulation)
EMC rating:	to EMC Directive

Electrical data

Contact resistance in new state:	max. 100 mΩ
Power consumption:	max. 3.2 W / 4 VA
Rated operating voltage U _g :	115 VAC / 230 VAC: –15% / +10% 24 VAC / VDC: –15% / +20%, residual ripple max. 10%
Frequency range:	50 Hz / 60 Hz (AC-operating voltage)
Fuse rating for the operating voltage (F1):	230 VAC-version: T 32 mA / 250 V 115 VAC-version: T 64 mA / 250 V 24 VAC / VDC-version: T 315 mA / 250 V

Monitored inputs	
Short-circuit recognition (Y/N):	No
Wire breakage detection (Y/N):	Yes
Earth leakage detection (Y/N):	Yes
Number of NO contacts:	0
Number of NC contacts:	0
Conduction resistance:	max. 40 Ω
Outputs	
Number of safety contacts:	3
Number of auxiliary contacts:	1
Number of signalling outputs:	0
Switching capacity of the safety contacts:	
- 13-14; 23-24; 33-34:	max. 250 V, 6 A ohmic (inductive in case of appropriate protective wiring); min. 10 V / 10 mA
Switching capacity of the auxiliary contacts:	41-42: 24 VDC / 2 A
Fuse rating of the safety contacts:	6.3 A slow blow
Recommended fuse for the auxiliary contacts:	2 A slow blow
Utilisation category to IEC / EN 60947-5-1:	AC-15: 230 VAC / 6 A DC-13: 24 VDC / 6 A
Dimensions H x W x D:	73.2 mm x 45 mm x 121 mm
The data specified in this manual are applicable when the component is operated with rated operating voltage $U_e \pm 0\%$.	

2.5 Safety classification

Standards:	EN ISO 13849-1, IEC 61508, EN 60947-5-1
PL:	up to e
Control category:	up to 4
DC:	99% (high)
CCF:	> 65 points
PFH value:	$\leq 2.00 \times 10^{-8}/h$
SIL:	up to 3
Service life:	20 years

The PFH value of $2.00 \times 10^{-8}/h$ applies to the combinations of contact load (current through enabling contacts) and number of switching cycles (n_{oply}) mentioned in the table below. At 365 operating days per year and a 24-hours operation, this results in the below-mentioned switching cycle times (t_{cycle}) for the relay contacts. Diverging applications upon request.

Contact load	n_{oply}	t_{cycle}
20 %	525,600	1.0 min
40 %	210,240	2.5 min
60 %	75,087	7.0 min
80 %	30,918	17.0 min
100 %	12,223	43.0 min

3. Mounting

3.1 General mounting instructions

Mounting: snaps onto standard DIN rails to EN 60715.

Snap the bottom of the enclosure slightly tilted forwards in the DIN rail and push down until it latches in position.

3.2 Dimensions

All measurements in mm.

Device dimensions (H/W/D): 73,2 mm x 45 mm x 121 mm

4. Electrical connection

4.1 General information for electrical connection



As far as the electrical safety is concerned, the protection against unintentional contact of the connected and therefore electrically interconnected apparatus and the insulation of the feed cables must be designed for the highest voltage, which can occur in the device.



The electrical connection may only be carried out by authorised personnel in a de-energised condition.

Wiring examples: see appendix



To avoid EMC disturbances, the physical ambient and operational conditions at the place where the product is installed, must meet the provisions laid down in the paragraph "Electromagnetic Compatibility (EMC)" of DIN EN 60204-1.

5. Operating principle and settings

5.1 LED functions

ON: Status operating voltage (LED is on, when the operating voltage on the terminals is ON)
 A: channel A (on, when frequency at channel A)
 B: channel B (on, when frequency at channel B)
 OUT: enabling signal (on when 13-14, 23-24, 33-34 closed)
 ERR: error (on in case of malfunction)

5.2 Description of the terminals

Voltages:	A1* A2*	+24 VDC/24 VAC / 115 VAC / 230 VAC 0 VDC/24 VAC
Outputs:	13-14 23-24 33-34	First safety enabling circuit Second safety enabling circuit Third safety enabling circuit
Start:	X1-X2 41-42	Feedback circuit Auxiliary contact

* depending on the operating voltage variant



Signalling outputs must not be used in safety circuits.

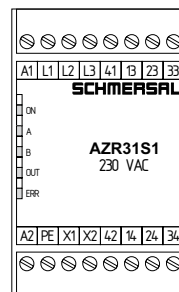

Fig. 1

5.3 Notes

Operating principle

The safety-monitoring module checks the correct position of all internal relay contacts. During start-up, every motor generates an induced voltage caused by residual magnetism, which is evaluated by the safety-monitoring module. Any interruption of the motor cable is detected and recognised as well. To activate the AZR 31S1, the connected motor must be standing still and the feedback input X1/X2 must be closed.



When the AZR 31S1 is connected to cable lengths > 10 m, failures of the standstill monitor can occur.

We therefore recommend:

- short and shielded connecting cables between the safety-monitoring module and the motor,
- lay cables to other high-capacity consumers (motors etc.) or strong interference sources (frequency converters) at sufficient distance and if possible not parallel to the signal input lines (L1, L2, L3) of the safety-monitoring module.

When using frequency converters, please observe that

- the terminal stage of the frequency converter is switched off when the motor is at standstill,
- there is no position control when the motor is at standstill.

In order to avoid any inadvertent switch-off or malfunction (ERR-LED) of the safety-monitoring module, please ensure that

- external influences do not trigger any movement of the motor,
- no rotary movement of the motor can occur as soon as the self-test is started (i.e. motor at standstill, LED's A and B simultaneously flashing).

5.4 Application hints

Single-channel control (star contactor is not pulled-in) (Fig. 2)

- If the application does not allow for the star contactor to be pulled-in after the motor is switched off, a single-channel control of the AZR 31S1 can be realised.
- Category 1 – PL c to DIN EN ISO 13849-1

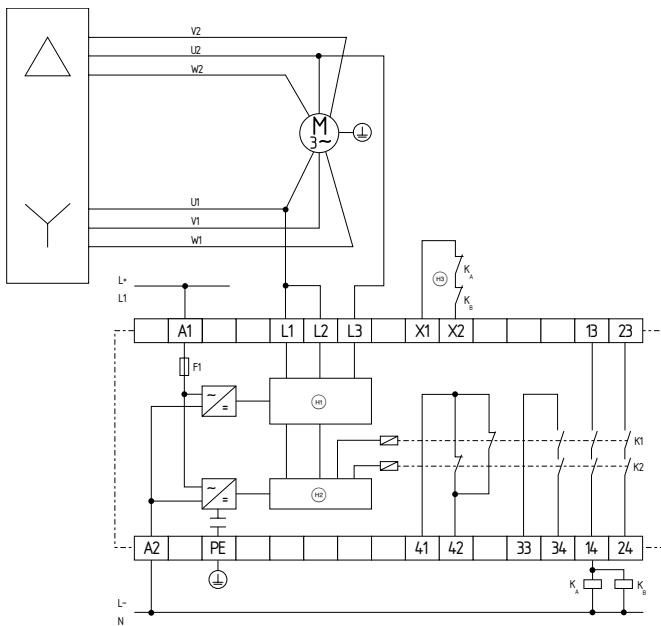

Fig. 2
R = Signal processing
Ⓜ = Monitoring
Ⓜ = Feedback circuit

Dual-channel control (star contactor pulled-in, also when motor is stationary) (Fig. 3)

- In case of automatic star delta start or pole changing, the star contactor must be pulled in during the measurement process.

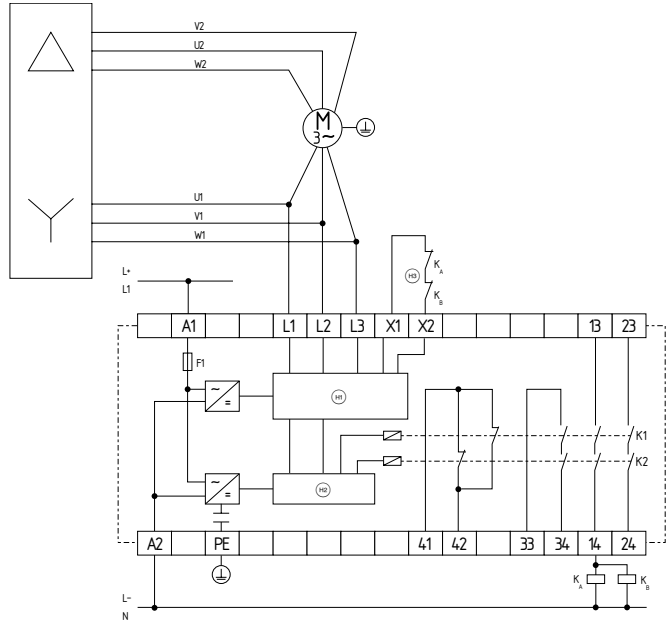

Fig. 3
R = Signal processing
Ⓜ = Monitoring
Ⓜ = Feedback circuit

6. Set-up and maintenance

6.1 Functional testing

The safety function of the safety-monitoring module must be tested. The following conditions must be previously checked and met:

1. Correct fixing
2. Check the integrity of the cable entry and connections
3. Check the safety-monitoring module's enclosure for damage
4. Check the electrical function of the connected sensors and their influence on the safety-monitoring module and the downstream actuators

6.2 Maintenance

A regular visual inspection and functional test, including the following steps, is recommended:

1. Check the correct fixing of the safety-monitoring module
2. Check the cable for damages
3. Check electrical function



The device has to be integrated into the periodic check-ups according to the Ordinance on Industrial Safety and Health, however at least 1 x year.

Damaged or defective components must be replaced.

7. Disassembly and disposal

7.1 Disassembly

The safety-monitoring module must be disassembled in a de-energised condition only.

Unlock the bottom of the enclosure by means of a slot screwdriver, push up and hang out slightly tilted forwards.

7.2 Disposal

The safety-monitoring module must be disposed of in an appropriate manner in accordance with the national prescriptions and legislations.

8. Appendix

8.1 Wiring example

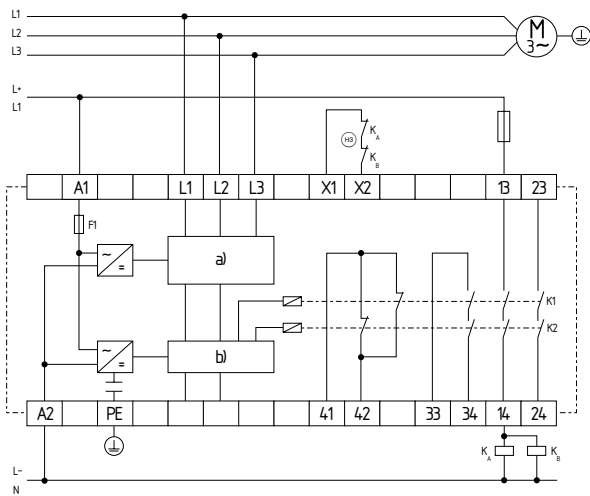

Fig. 4
a) Signal processing;
b) Monitoring

Wiring example 1 (Fig. 5)

- If the feedback circuit is not required, establish a bridge.



When the AZR 31S1 safety-monitoring module is used, an automatic restart after a shutdown in case of emergency must be prevented by the upstream control to EN 60204-1 paragraph 9.2.5.4.2 and 10.8.3.

Wiring example 2 (Fig. 6)

- The control is realised through 3 phases of the AC network.
- Wire breakage between the motor windings is detected.
- Control category: 4 - PL e to DIN EN ISO 13849-1 possible



When the AZR 31S1 safety-monitoring module is used, an automatic restart after a shutdown in case of emergency must be prevented by the upstream control to EN 60204-1 paragraph 9.2.5.4.2 and 10.8.3.



Fig. 5

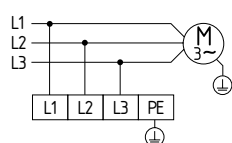

Fig. 6

Wiring example 3 (Fig. 7)

- The control is realised through L1 and N of the AC network.
- Wire breakage between the motor windings is detected.
- Control category: 2 - PL e to DIN EN ISO 13849-1 possible

Wiring example 4 (see fig. 8)

- Single-channel control
 - Suitable for increase in capacity or number of contacts by means of contactors or relays with positive-guided contacts.
 - If the feedback circuit is not required, establish a bridge.
- * = Feedback circuit

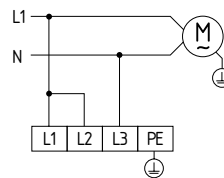

Fig. 7

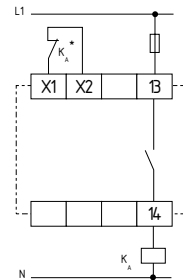

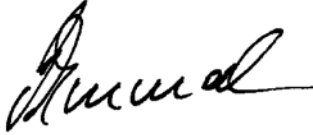

Fig. 8

9. Declaration of conformity

9.1 EC Declaration of conformity

	
<h2>EC Declaration of conformity</h2>	
Translation of the original Declaration of Conformity	K.A. Schmersal GmbH & Co. KG Industrielle Sicherheitssysteme Mödinghofe 30, 42279 Wuppertal Germany Internet: www.schmersal.com
<p>We hereby certify that the hereafter described safety components both in its basic design and construction conform to the applicable European Directives.</p>	
Name of the safety component:	AZR 31S1
Description of the safety component:	Safety-monitoring module for motor standstill monitoring
Relevant EC-Directives:	2006/42/EC-EC-Machinery Directive 2004/108/EC EMC-Directive
Person authorized for the compilation of the technical documentation:	Oliver Wacker Mödinghofe 30 42279 Wuppertal
Notified body, which approved the full quality assurance system, referred to in Appendix X, 2006/42/EC:	TÜV Rheinland Industrie Service GmbH Alboinstraße 56 12103 Berlin ID n°: 0035
Place and date of issue:	Wuppertal, January 6, 2014
AZR31S1-C-EN	
	Authorised signature Philip Schmersal Managing Director



The currently valid declaration of conformity can be downloaded from the internet at www.schmersal.net.



K. A. Schmersal GmbH & Co. KG
Industrielle Sicherheitssysteme
Mödinghofe 30, D - 42279 Wuppertal
Postfach 24 02 63, D - 42232 Wuppertal

Phone: +49 - (0)2 02 - 64 74 - 0
Telefax +49 - (0)2 02 - 64 74 - 1 00
E-Mail: info@schmersal.com
Internet: <http://www.schmersal.com>