



**EN** Operating instructions..... pages 1 to 6  
Translation of the original operating instructions

**FR** Vous trouverez la version actuelle du mode d'emploi dans votre langue nationale officielle sur l'Internet, [www.schmersal.net](http://www.schmersal.net).

**ES** Encontrará el manual de instrucciones actual en su idioma oficial de la UE en nuestra página de Internet [www.schmersal.net](http://www.schmersal.net).

**NL** U vindt de huidige versie van de gebruikshandleiding in uw officiële landstaal op het Internet, [www.schmersal.net](http://www.schmersal.net).

**IT** Il manuale d'istruzioni aggiornato nella vostra lingua (lingua ufficiale UE) è scaricabile in Internet all'indirizzo [www.schmersal.net](http://www.schmersal.net).

**JP** EU公用語で書かれた最新の取扱説明書は、インターネット ([www.schmersal.net](http://www.schmersal.net)) からダウンロードできます。

## Content

<b>1 About this document</b>	
1.1 Function .....	1
1.2 Target group: authorised qualified personnel .....	1
1.3 Explanation of the symbols used .....	1
1.4 Appropriate use .....	1
1.5 General safety instructions .....	1
1.6 Warning about misuse .....	1
1.7 Exclusion of liability .....	2
<b>2 Product description</b>	
2.1 Ordering code .....	2
2.2 Special versions .....	2
2.3 Destination and use .....	2
2.4 Technical data .....	3
<b>3 Mounting</b>	
3.1 Dimensions .....	3
<b>4 Electrical connection</b>	
4.1 General information for electrical connection .....	3
4.2 Contact variants .....	3
<b>5 Set-up and maintenance</b>	
5.1 Functional testing .....	4
5.2 Maintenance .....	4
<b>6 Disassembly and disposal</b>	
6.1 Disassembly .....	4
6.2 Disposal .....	4
<b>7 Appendix</b>	
7.1 EC Declaration of conformity .....	5

## 1 About this document

### 1.1 Function

This operating instructions manual provides all the information you need for the mounting, set-up and commissioning to ensure the safe operation and disassembly of the foot switch. The operating instructions must be available in a legible condition and a complete version in the vicinity of the device.

### 1.2 Target group: authorised qualified personnel

All operations described in this operating instructions manual must be carried out by trained specialist personnel, authorised by the plant operator only.

Please make sure that you have read and understood these operating instructions and that you know all applicable legislations regarding occupational safety and accident prevention prior to installation and putting the component into operation.

The machine builder must carefully select the harmonised standards to be complied with as well as other technical specifications for the selection, mounting and integration of the components.

### 1.3 Explanation of the symbols used



#### Information, hint, note:

This symbol is used for identifying useful additional information.



**Caution:** Failure to comply with this warning notice could lead to failures or malfunctions.

**Warning:** Failure to comply with this warning notice could lead to physical injury and/or damage to the machine.

### 1.4 Appropriate use

The products described in these operating instructions are developed to execute safety-related functions as part of an entire plant or machine. It is the responsibility of the manufacturer of a machine or plant to ensure the proper functionality of the entire machinery or plant.

The component must be exclusively used in accordance with the versions listed below or for the applications authorised by the manufacturer. Detailed information regarding the range of applications can be found in the chapter „Product description“.

### 1.5 General safety instructions

The user must observe the safety instructions in this operating instructions manual, the country-specific installation standards as well as all prevailing safety regulations and accident prevention rules.



Further technical information can be found in the Schmersal catalogues or in the online catalogue on the Internet: [www.schmersal.net](http://www.schmersal.net).

The information contained in this operating instructions manual is provided without liability. Subject to technical modifications.

There are no residual risks, provided that the safety instructions as well as the instructions regarding mounting, commissioning, operation and maintenance are observed.

### 1.6 Warning about misuse



In case of inadequate or improper use or manipulations of the foot switch, personal hazards or damage to machinery or plant components cannot be excluded. The relevant requirements of the standard EN 1088 must be observed.

### 1.7 Exclusion of liability

We shall accept no liability for damages and malfunctions resulting from defective mounting or failure to comply with this operating instructions manual. The manufacturer shall accept no liability for damages resulting from the use of unauthorised spare parts or accessories.

For safety reasons, invasive work on the device as well as arbitrary repairs, conversions and modifications to the device are strictly forbidden; the manufacturer shall accept no liability for damages resulting from such invasive work, arbitrary repairs, conversions and/or modifications to the device.

## 2 Product description

### 2.1 Ordering code

This operating instructions manual applies to the following types:

①F② 232-③-④		
No.	Option	Description
①	T	Slow action
	Z	Snap action
②		without protective shield
	H	with protective shield
③	11	1 NO contact / 1 NC contact
	02	2 NC contacts
	20	2 NO contacts
	22	2 NO contacts / 2 NC contacts
	04	4 NC contacts
	40	4 NO contacts
④	HD	Staggering with pressure point
	F	Bi-stable function

①2F② 232-③-④		
No.	Option	Description
①	T	Slow action
	Z	Snap action
②		without protective shield
	H	with protective shield
③		per pedal:
	11/11	1 NO contact / 1 NC contact
	02/02	2 NC contacts
	20/20	2 NO contacts
	22/22	2 NO contacts / 2 NC contacts
	04/04	4 NC contacts
40/40	4 NO contacts	
④	HD	Staggered contacts with pressure point

### 2.2 Special versions

For special versions, which are not listed in the order code below 2.1, these specifications apply accordingly, provided that they correspond to the standard version.

### 2.3 Destination and use

These robust foot switches are particularly suitable for industrial applications. They are equipped with slow or snap action switch inserts. The foot switches with ordering suffix H are mounted with a shield to protect against unintentional actuation.

### Staggered operating principle (ordering suffix -HD)

The staggering is realised by means of a pressure point, which is installed under the pedal. When the foot pedal is actuated as far as the pressure point, 1 NO contact is closed. If the pedal is actuated beyond the pressure point, the second NO contact is closed. The first pair of contacts remain enabled.

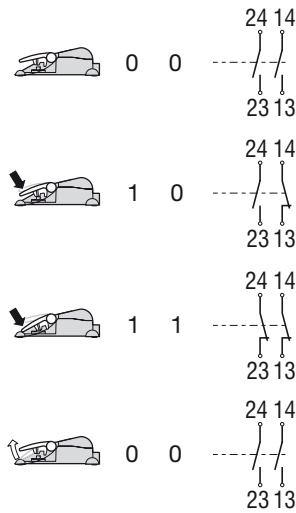

### Bi-stable operating principle (ordering suffix -F)

Upon the first foot lever action, the switch insert is switched on (= ON). Upon the second foot lever action, the latching of the switching elements is neutralised, i.e. the switch insert is switched off by the spring in the switch insert (= OFF) (push/push function).

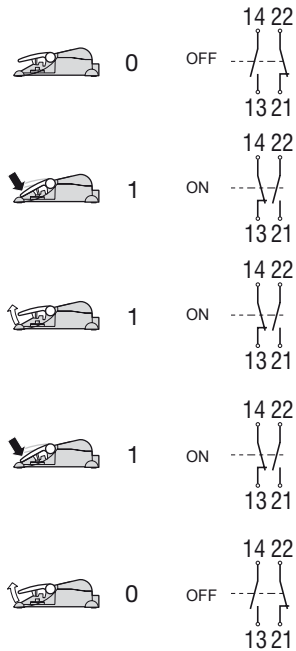

**2.4 Technical data**

Standards:	IEC/EN 60947-5-1, UL 508
Enclosure/shield/cover:	Aluminium die-cast, powder-coated
Pedal:	glass-fibre reinforced thermoplastic
Cable entry:	1 pedal: 1 x M20 x 1.5 2 pedals: 2 x M25 x 1.5
Protection class:	IP 65 to IEC/EN 60529
Switching system:	Slow action 1 NC / 1 NO contact; 2 NO contacts; 2 NC contacts Snap action 1 NC / 1 NO contact; 2 NC contacts
Termination:	Screw terminals
Cable section:	max. 2.5 mm <sup>2</sup> (incl. conductor ferrules)
Utilisation category:	AC-15/DC-13
I <sub>e</sub> /U <sub>e</sub> :	4 A / 230 VAC, 1 A / 24 VDC
U <sub>imp</sub> :	6 kV
U <sub>i</sub> :	500 VAC
I <sub>the</sub> :	10 A
Max. fuse rating:	6 A gG D-fuse (DIN/EN 60269-1)
Ambient temperature:	-25 °C ... +70 °C
Mechanical life:	> 1 million operations

 Openings shall be closed by equipment rated for enclosure types: 3, 3R, 3RX, 3S, 3SX, 3X, 5, 4, 4X, 6, 6P, 12, or 13. Use 105°C wires/cables only.

**3 Mounting**

**3.1 Dimensions**

All measurements in mm.

TZ(H)/ZF(H), 1 foot pedal

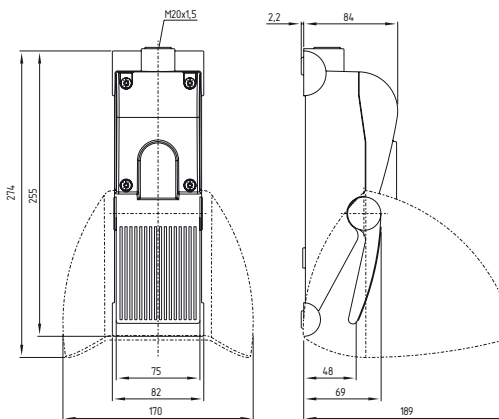

T2Z(H)/Z2F(H), 2 foot pedals

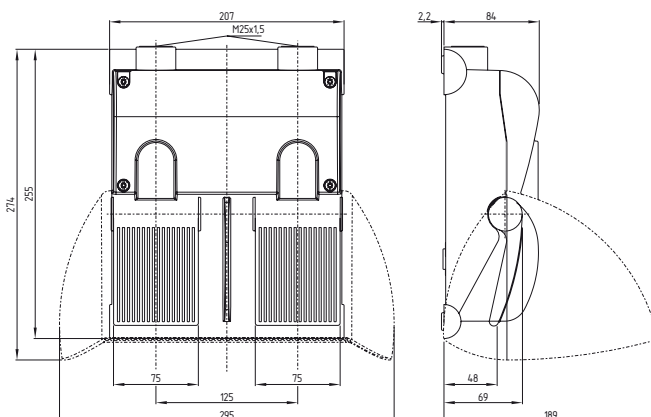

**4 Electrical connection**

**4.1 General information for electrical connection**



The electrical connection may only be carried out by authorised personnel in a de-energised condition.

The contact labelling can be found in the wiring compartment of the switch. For the cable entry, suitable cable glands with an appropriate degree of protection must be used. The cables must be laid correctly in the wiring compartment of the switch. For foot switches with 1 foot pedal, the M20 x 1.5 cable entry is available, for foot switches with 2 foot pedals, 2x M25 x 1.5. The non-used cable entry must be sealed with blanking plugs. After wiring, the wiring compartment of the switch must definitely be cleaned (e.g. removal of cables residues), considering that foreign bodies can affect the switching behaviour. The tightening torque for the cover screws is min. 1.8 Nm.

**4.2 Contact variants**

The contacts are shown in non-actuated condition.

**with 1 foot pedal**

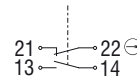

TF 232-11; TFH 232-11;  
ZF 232-11; ZFH 232-11

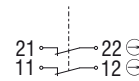

TF 232-02; TFH 232-02;  
ZF 232-02; ZFH 232-02



TF 232-20; TFH 232-20

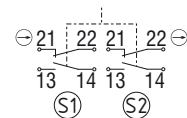

TF 232-22; TFH 232-22;  
ZF 232-22; ZFH 232-22

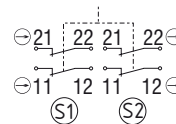

TF 232-04; TFH 232-04;  
ZF 232-04; ZFH 232-04

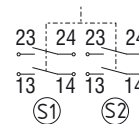

TF 232-04; TFH 232-04;  
ZF 232-04; ZFH 232-04

**with 2 foot pedals**

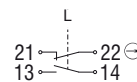

T2F 232-11/11; T2FH 232-11/11;  
Z2F 232-11/11; Z2FH 232-11/11

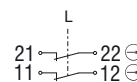
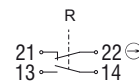

T2F 232-02/02; T2FH 232-02/02;  
Z2F 232-02/02; Z2FH 232-02/02

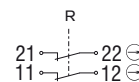

T2F 232-20/20; T2FH 232-20/20



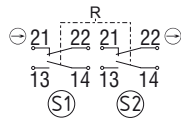
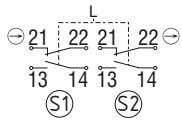

T2F 232-22/22; T2FH 232-22/22;  
Z2F 232-22/22; Z2FH 232-22/22

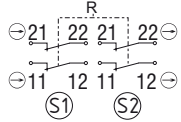
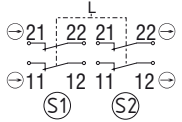

T2F 232-04/04; T2FH 232-04/04;  
Z2F 232-04/04; Z2FH 232-04/04

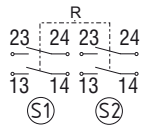
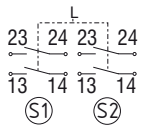

T2F 232-40/40; T2FH 232-40/40

**Legend:** ⊖ Positive break NC contact  
L left pedal  
R right pedal

## 5 Set-up and maintenance

### 5.1 Functional testing

The function of the component must be tested. The following conditions must be previously checked and met:

1. Check the integrity of the cable entry and connections
2. Check the switch enclosure for damage
3. Check the functionality of the switch by actuating the foot switch

### 5.2 Maintenance

The function (switching) of the foot switch must be tested in regular intervals. Possible soiling accumulated below the foot pedal must be removed.

A regular visual inspection and functional test, including the following steps, is recommended:

- Check the switch enclosure for damages
- Check the cable entries and the wire connections

**Damaged or defective components must be replaced.**

## 6 Disassembly and disposal



### 6.1 Disassembly

The switchgear must be disassembled in a de-energised condition only.

### 6.2 Disposal

The switchgear must be disposed of in an appropriate manner in accordance with the national prescriptions and legislations.

7.1 EC Declaration of conformity

	
<b>EC Declaration of conformity</b>	
Translation of the original declaration of conformity	SCHMERSAL Industrial Switchgear (Shanghai) Co., Ltd. Wai Qing Song Road 5388 Qingpu 201700 Shanghai P.R. China Internet: www.schmersal.com.cn
We hereby certify that the hereafter described products both in their basic design and construction conform to the applicable European Directives.	
<b>Name of the component:</b>	Z/TF 232
<b>Description of the component:</b>	Foot switches
<b>Harmonised EC-Directives:</b>	2006/95/EC EC Low Voltage Directive
<b>Place and date of issue:</b>	Shanghai, November 11, 2009
	
	Authorised signature Dr. Youqi Liu Managing Director



**Note**

The currently valid declaration of conformity can be downloaded from the internet at [www.schmersal.net](http://www.schmersal.net).



**K. A. Schmersal GmbH**  
**Industrielle Sicherheitsschaltssysteme**  
Möddinghofe 30, D - 42279 Wuppertal  
Postfach 24 02 63, D - 42232 Wuppertal

Telefon +49 - (0)2 02 - 64 74 - 0  
Telefax +49 - (0)2 02 - 64 74 - 1 00  
E-Mail: [info@schmersal.com](mailto:info@schmersal.com)  
Internet: <http://www.schmersal.com>

**Production site:**  
**SCHMERSAL**  
**Industrial Switchgear (Shanghai) Co., Ltd.**  
Wai Qing Song Road 5388  
Qingpu 201700 Shanghai, P.R.CHINA

Telefon +86 - (0)21 - 69210585  
Telefax +86 - (0)21 - 69210586  
E-Mail: [info@schmersal.com.cn](mailto:info@schmersal.com.cn)  
Internet: <http://www.schmersal.com.cn>