



EN Operating instructions..... pages 7 to 12
Translation of the original operating instructions

FR Vous trouverez la version actuelle du mode d'emploi dans votre langue nationale officielle sur l'Internet, www.schmersal.net.

ES Encontrará el manual de instrucciones actual en su idioma oficial de la UE en nuestra página de Internet www.schmersal.net.

NL U vindt de huidige versie van de gebruikshandleiding in uw officiële landstaal op het Internet, www.schmersal.net.

IT Il manuale d'istruzioni aggiornato nella vostra lingua (lingua ufficiale UE) è scaricabile in Internet all'indirizzo www.schmersal.net.

JP EU公用語で書かれた最新の取扱説明書は、インターネット(www.schmersal.net)からダウンロードできます。

Content

1 About this document	
1.1 Function	1
1.2 Target group: authorised qualified personnel	1
1.3 Explanation of the symbols used	1
1.4 Appropriate use	1
1.5 General safety instructions	1
1.6 Warning about misuse	1
1.7 Exclusion of liability	2
2 Product description	
2.1 Ordering code	2
2.2 Special versions	2
2.3 Destination and use	2
2.4 Technical data	2
2.5 Safety classification	3
3 Mounting	
3.1 General mounting instructions	3
3.2 Dimensions	3
4 Electrical connection	
4.1 General information for electrical connection	3
5 Operating principle and settings	
5.1 LED functions	3
5.2 Description of the terminals	3
6 Set-up and maintenance	
6.1 Functional testing	4
6.2 Maintenance	4
7 Disassembly and disposal	
7.1 Disassembly	4
7.2 Disposal	4
8 Appendix	
8.1 Wiring examples	4
8.2 Start configuration	4
8.3 Sensor configuration	4
8.4 Actuator configuration	5
8.5 EC Declaration of conformity	6

1 About this document

1.1 Function

This operating instructions manual provides all the information you need for the mounting, set-up and commissioning to ensure the safe operation and disassembly of the safety-monitoring module. The operating instructions must be available in a legible condition and a complete version in the vicinity of the device.

1.2 Target group: authorised qualified personnel

All operations described in this operating instructions manual must be carried out by trained specialist personnel, authorised by the plant operator only.

Please make sure that you have read and understood these operating instructions and that you know all applicable legislations regarding occupational safety and accident prevention prior to installation and putting the component into operation.

The machine builder must carefully select the harmonised standards to be complied with as well as other technical specifications for the selection, mounting and integration of the components.

1.3 Explanation of the symbols used



Information, hint, note:

This symbol is used for identifying useful additional information.



Caution: Failure to comply with this warning notice could lead to failures or malfunctions.

Warning: Failure to comply with this warning notice could lead to physical injury and/or damage to the machine.

1.4 Appropriate use

The products described in these operating instructions are developed to execute safety-related functions as part of an entire plant or machine. It is the responsibility of the manufacturer of a machine or plant to ensure the proper functionality of the entire machinery or plant.

The safety-monitoring module must be exclusively used in accordance with the versions listed below or for the applications authorised by the manufacturer. Detailed information regarding the range of applications can be found in the chapter "Product description".

1.5 General safety instructions

The user must observe the safety instructions in this operating instructions manual, the country-specific installation standards as well as all prevailing safety regulations and accident prevention rules.



Further technical information can be found in the Elan catalogues or in the online catalogue on the Internet: www.schmersal.net.

The information contained in this operating instructions manual is provided without liability and is subject to technical modifications.

There are no residual risks, provided that the safety instructions as well as the instructions regarding mounting, commissioning, operation and maintenance are observed.

1.6 Warning about misuse



In case of inadequate or improper use or manipulations of the safety-monitoring module, personal hazards or damage to machinery or plant components cannot be excluded. The relevant requirements of the standard EN 1088 must be observed.

1.7 Exclusion of liability

We shall accept no liability for damages and malfunctions resulting from defective mounting or failure to comply with this operating instructions manual. The manufacturer shall accept no liability for damages resulting from the use of unauthorised spare parts or accessories.

For safety reasons, invasive work on the device as well as arbitrary repairs, conversions and modifications to the device are strictly forbidden; the manufacturer shall accept no liability for damages resulting from such invasive work, arbitrary repairs, conversions and/or modifications to the device.

2 Product description

2.1 Ordering code

This operating instructions manual applies to the following types:

SRB 200X2



Only if the information described in this operating instructions manual are realised correctly, the safety function and therefore the compliance with the Machinery Directive is maintained.

2.2 Special versions

For special versions, which are not listed in the order code below 2.1, these specifications apply accordingly, provided that they correspond to the standard version.

2.3 Destination and use

The safety-monitoring modules for integration in safety circuits are designed for fitting in control cabinets. They are used for the safe evaluation of the signals of positive break position switches or magnetic safety sensors for safety functions on sliding, hinged and removable safety guards as well as emergency stop control devices and AOPD's.

The safety function is defined as the opening of the enabling circuits 13-14 and 23-24 when the inputs S11 - S12 and/or S11 - S22 are opened or when the supply voltage A1 is disconnected. The safety-relevant current paths with the output contacts 13-14 and 23-24 meet the following requirements under observation of a B_{10d} value assessment (also refer to "Requirements of DIN EN ISO 13849-1"):

- Category 4 - PL e to DIN EN ISO 13849-1
- SIL 3 to DIN EN 61508-2
- SILCL 3 to DIN EN 62061

(meets the requirements of control category 4 to DIN EN 954-1)

To determine the Performance Level (PL) of the entire safety function (e.g. sensor, logic, actuator) to DIN EN ISO 13849-1, an analysis of all relevant components is required.

2.4 Technical data

General data:

Standards:	IEC/EN 60204-1, EN 60947-5-1; EN ISO 13849-1, IEC/EN 61508
Climate resistance:	EN 60068-2-78
Fixing:	Snaps onto standard DIN rails to DIN EN 60715
Terminal designations:	EN 60947-1
Material of the enclosure:	glass-fibre reinforced thermoplastic, ventilated
Material of the contacts:	AgSnO, self-cleaning, positive drive
Weight:	230 g
Start conditions	Start button (monitored)
Feedback circuit (Y/N):	Yes
Drop-out delay:	1-channel input circuit: typ. 50 ms 2-channel input circuit: typ. 20 ms
Pull-in delay:	typ. 20 ms
Bridging in case of voltage drops:	typ. 50 ms

Mechanical data:

Connection type:	Screw connection
Cable section:	min. 2 mm ² / max. 2 mm ²
Connecting cable:	rigid or flexible
Tightening torque for the terminals:	0.6 Nm
With removable terminals (Y/N):	No
Mechanical life:	10 million operations
Electrical life:	Derating curve available on request
Resistance to shock:	10 g / 11 ms
Resistance to vibrations to EN 60068-2-6:	10 ... 55 Hz, amplitude 0.35 mm

Ambient conditions:

Ambient temperature:	–25°C ... +60°C
Storage and transport temperature:	–40°C ... +85°C
Protection class:	Enclosure: IP 40 Terminals: IP 20 Wiring compartment: IP 54
Air clearances and creepage distances to IEC/EN 60664-1:	4 kV/2 (basic insulation)
EMC rating:	to EMC Directive

Electrical data:

Contact resistance in new state:	max. 100 mΩ
Power consumption:	max. 1.5 W / 3.0 VA
Rated operating voltage U _e :	24 VDC –15%/+20%, residual ripple max. 10% 24 VAC –15% / +10%
Frequency range:	50 Hz / 60 Hz
Max. fuse rating of the operating voltage:	internal electronic fuse, tripping current > 1 A, reset after approx. 1 sec.

Current and voltage at:	S11-S12: 24 VDC, permanent current: 40 mA, start impulse: 700 mA / 5 ms
	S21-S22: 24 VDC, permanent current: 40 mA, start impulse: 700 mA / 5 ms
	S33-S34: 24 VDC, start impulse 200 mA / 5 ms

Monitored inputs:

Cross-wire detection (Y/N):	Yes (if dual-channel)
Wire breakage detection (Y/N):	Yes
Earth leakage detection (Y/N):	Yes
Number of NO contacts:	0
Number of NC contacts:	2
Cable lengths:	1-channel without cross-wire short detection: – 1,500 m with 1.5 mm ² – 2,500 m with 2.5 mm ² 2-channel without cross-wire short detection
Conduction resistance:	max. 40 Ω

Outputs:	
Number of safety contacts:	2
Number of auxiliary contacts:	0
Number of signalling outputs:	0
Switching capacity of the safety contacts:	13-14; 23-24: max. 230 V, 8 A ohmic (inductive in case of appropriate protective wiring) min. 10 V / 10 mA; AC-15: 230 VAC / 6 A; DC-13: 24 VDC / 6 A
Fuse rating of the safety contacts:	8 A slow blow
Utilisation category to EN 60947-5-1:	AC-15 / DC-13: EN 60947-5-1
Dimensions (H/W/D):	100 mm x 22,5 mm x 121 mm
The data specified in this manual is applicable when the component is operated with rated operating voltage $U_e \pm 0\%$.	

2.5 Safety classification

Standards:	EN ISO 13849-1, IEC 61508, EN 60947-5-1
PL:	Stop 0: up to e
Control category:	Stop 0: up to 4
DC:	Stop 0: 99% (high)
CCF:	> 65 points
SIL:	Stop 0: up to 3
Service life:	20 years
B_{10d} value (for one channel):	Low voltages range 20%: 20,000,000 40%: 7,500,000 60%: 2,500,000 80%: 1,000,000 Maximum load 100%: 400,000

$$MTTF_d = \frac{B_{10d}}{0,1 \times n_{op}} \quad n_{op} = \frac{d_{op} \times h_{op} \times 3600 \text{ s/h}}{t_{cycle}}$$

For an average annual demand rate of $n_{op} = 126,720$ cycles per year, Performance Level PL e can be obtained at maximum load.

n_{op} = average number of activations per year
 d_{op} = average number of operating days per year
 h_{op} = average number of operating hours per day
 t_{cycle} = average demand rate of the safety function in s
 (e.g. 4 × per hour = 1 × per 15 min. = 900 s)

(Specifications can vary depending on the application-specific parameters h_{op} , d_{op} and t_{cycle} as well as the load.)

3 Mounting

3.1 General mounting instructions

Mounting: snaps onto standard DIN rails to EN 60715.

Snap the bottom of the enclosure slightly tilted forwards in the DIN rail and push up until it latches in position.

3.2 Dimensions

All measurements in mm.

Device dimensions (H/W/D): 100 x 22.5 x 121 mm

4 Electrical connection

4.1 General information for electrical connection



The electrical connection may only be carried out by authorised personnel in a de-energised condition.

Wiring examples: see appendix

5 Operating principle and settings

5.1 LED functions

- K1: Status channel 1
- K2: Status channel 2
- U_B : Status internal operating voltage (LED is on, when the operating voltage on the terminals A1-A2 is ON and the fuse has not been triggered)

5.2 Description of the terminals

Voltages:	A1	+24 VDC/24 VAC
	A2	0 VDC/24 VAC
Inputs:	S11-S12	Input channel 1 (+)
	S21-S22	Input channel 2 (-)
Outputs:	13-14	First safety enabling circuit
	23-24	Second safety enabling circuit
Start:	S33-S34	Feedback circuit and external reset

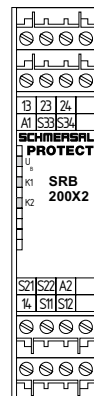

Fig. 1

6 Set-up and maintenance

6.1 Functional testing

The safety function of the safety-monitoring module must be tested. The following conditions must be previously checked and met:

1. Correct fixing
2. Check the integrity of the cable entry and connections
3. Check the safety-monitoring module's enclosure for damage.
4. Check the electrical function of the connected sensors and their influence on the safety-monitoring module and the downstream actuators

6.2 Maintenance

A regular visual inspection and functional test, including the following steps, is recommended:

1. Check the correct fixing of the safety-monitoring module
2. Check the cable for damages
3. Check electrical function

Damaged or defective components must be replaced.

7 Disassembly and disposal

7.1 Disassembly

The safety-monitoring module must be disassembled in a de-energised condition only.

7.2 Disposal

The safety-monitoring module must be disposed of in an appropriate manner in accordance with the national prescriptions and legislations.

8 Appendix

8.1 Wiring examples

2-channel control, shown for a guard door monitor with two position switches where one has a positive break contact; with external reset button [®] (Fig. 2)

- Relay outputs: Suitable for 2-channel control, for increase in capacity or number of contacts by means of contactors or relays with positive-guided contacts.
- The control system recognises wire breakage, earth faults and cross-wire shorts in the monitoring circuit.
- [®] = Feedback circuit

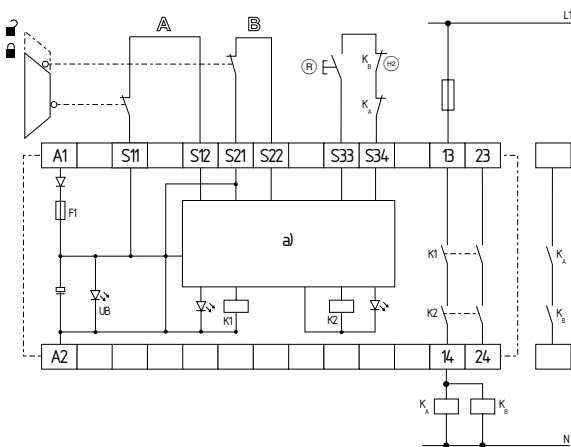

Fig. 2
a) Logic

8.2 Start configuration

External reset button (with edge detection) (see Fig. 3)

- The external reset button is integrated as shown.
- The safety-monitoring module is activated by the reset (after release) of the reset button (= detection of the falling edge). Faults in the reset button, e.g. welded contacts or manipulations which could lead to an inadvertent restart, are detected in this configuration and will result in an inhibition of the operation.

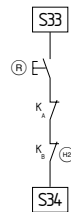

Fig. 3

8.3 Sensor configuration

Single-channel emergency stop circuit with command devices to DIN EN ISO 13850 (EN 418) and EN 60947-5-5 (Fig. 4)

- Wire breakage and earth leakage in the control circuits are detected.
- Possible control categories:
 - 1 to EN 954-1
 - 2 – PL d to DIN EN ISO 13849-1

Dual-channel emergency stop circuit with command devices to DIN EN ISO 13850 (EN 418) and EN 60947-5-5 (Fig. 5)

- Wire breakage and earth leakage in the control circuits are detected.
- Cross-wire shorts between the control circuits are detected.
- Possible control categories:
 - 4 to EN 954-1
 - 4 – PL e to DIN EN ISO 13849-1

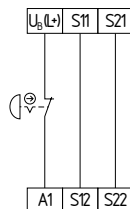

Fig. 4

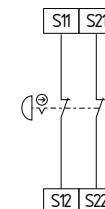

Fig. 5

Single-channel guard door monitoring circuit with interlocking devices to EN 1088 (Fig. 6)

- At least one contact with positive break required
- Wire breakage and earth leakage in the control circuits are detected.
- Possible control categories:

- 1 to EN 954-1
- 2 – PL d to DIN EN ISO 13849-1

Dual-channel guard door monitoring circuit with interlocking device to EN 1088 (Fig. 7)

- At least one contact with positive break required
- Wire breakage and earth leakage in the control circuits are detected.
- Cross-wire shorts between the control circuits are detected.
- Possible control categories:

- 4 to EN 954-1
- 4 – PL e to DIN EN ISO 13849-1

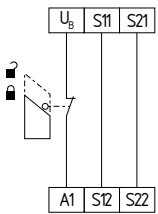

Fig. 6

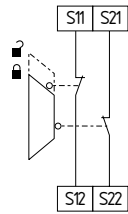

Fig. 7

8.4 Actuator configuration

Single-channel control with feedback circuit (Fig. 8)

- Suitable for increase in capacity or number of contacts by means of contactors or relays with positive-guided contacts.
- Ⓜ = feedback circuit:
If the feedback circuit is not required, establish a bridge.

Dual-channel control with feedback circuit (Fig. 9)

- Suitable for increase in capacity or number of contacts by means of contactors or relays with positive-guided contacts.
- Ⓜ = feedback circuit:
If the feedback circuit is not required, establish a bridge.

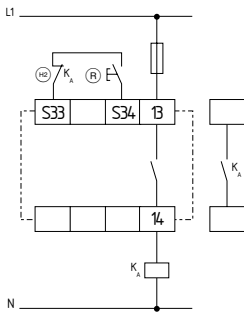

Fig. 8

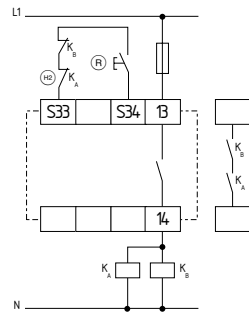



Fig. 9

8.5 EC Declaration of conformity

	
<h2>EC Declaration of conformity</h2>	
Translation of the original declaration of conformity valid as of December 29, 2009	Elan Schaltelemente GmbH & Co. KG Im Ostpark 2 · 35435 Wettenberg Germany Internet: www.elan.de
We hereby certify that the hereafter described safety components both in its basic design and construction conforms to the applicable European Directives.	
Name of the safety component:	SRB 200X2
Description of the safety component:	Safety-monitoring module for emergency stop circuits and guard door monitoring
Harmonised EC-Directives:	2006/42/EC EC-Machinery Directive 2004/108/EC EMC-Directive
Person authorized for the compilation of the technical documentation:	Ulrich Loss Möddinghofe 30 42279 Wuppertal
Notified body, which approved the full quality assurance system, referred to in Appendix X, 2006/42/EC:	TÜV Rheinland Industrie Service GmbH Alboinstraße 56 12103 Berlin ID n°: 0035
Place and date of issue:	Wuppertal, October 6, 2009
SRB200X2-B-EN	
	Authorised signature Heinz Schmersal Managing Director



Note

The currently valid declaration of conformity can be downloaded from the internet at www.schmersal.net.



Elan Schaltelemente GmbH & Co. KG
Im Ostpark 2, D - 35435 Wettenberg
Postfach 1109, D - 35429 Wettenberg

Telefon: +4 9 (0)6 41 9848-0
Telefax: +49 (0)641 9848-420
E-Mail: info-elan@schmersal.com
Internet: www.elan.de