



EN Operating instructions..... pages 1 to 8
Translation of the original operating instructions

FR Vous trouverez la version actuelle du mode d'emploi dans votre langue nationale officielle sur l'Internet, www.schmersal.net.

ES Encontrará el manual de instrucciones actual en su idioma oficial de la UE en nuestra página de Internet www.schmersal.net.

NL U vindt de huidige versie van de gebruikshandleiding in uw officiële landstaal op het Internet, www.schmersal.net.

IT Il manuale d'istruzioni aggiornato nella vostra lingua (lingua ufficiale UE) è scaricabile in Internet all'indirizzo www.schmersal.net.

JP EU公用語で書かれた最新の取扱説明書は、インターネット (www.schmersal.net) からダウンロードできます。

Content

1 About this document	
1.1 Function	1
1.2 Target group: authorised qualified personnel	1
1.3 Explanation of the symbols used	1
1.4 Appropriate use	1
1.5 General safety instructions	1
1.6 Warning about misuse	1
1.7 Exclusion of liability	2
2 Product description	
2.1 Ordering code	2
2.2 Special versions	2
2.3 Destination and use	2
2.4 Technical data	2
2.5 Safety classification	3
3 Mounting	
3.1 General mounting instructions	3
3.2 Dimensions	3
4 Electrical connection	
4.1 General information for electrical connection	3
5 Operating principle and settings	
5.1 LED functions	3
5.2 Description of the terminals	3
6 Set-up and maintenance	
6.1 Functional testing	3
6.2 Maintenance	3
7 Disassembly and disposal	
7.1 Disassembly	3
7.2 Disposal	3
8 Appendix	
8.1 Wiring examples	4
8.2 Start configuration	4
8.3 Sensor configuration	4
8.4 Actuator configuration	7
8.5 EC Declaration of conformity	8

1 About this document

1.1 Function

This operating instructions manual provides all the information you need for the mounting, set-up and commissioning to ensure the safe operation and disassembly of the safety-monitoring module. The operating instructions must be available in a legible condition and a complete version in the vicinity of the device.

1.2 Target group: authorised qualified personnel

All operations described in this operating instructions manual must be carried out by trained specialist personnel, authorised by the plant operator only.

Please make sure that you have read and understood these operating instructions and that you know all applicable legislations regarding occupational safety and accident prevention prior to installation and putting the component into operation.

The machine builder must carefully select the harmonised standards to be complied with as well as other technical specifications for the selection, mounting and integration of the components.

1.3 Explanation of the symbols used



Information, hint, note:

This symbol is used for identifying useful additional information.



Caution: Failure to comply with this warning notice could lead to failures or malfunctions.

Warning: Failure to comply with this warning notice could lead to physical injury and/or damage to the machine.

1.4 Appropriate use

The products described in these operating instructions are developed to execute safety-related functions as part of an entire plant or machine. It is the responsibility of the manufacturer of a machine or plant to ensure the proper functionality of the entire machinery or plant.

The safety-monitoring module must be exclusively used in accordance with the versions listed below or for the applications authorised by the manufacturer. Detailed information regarding the range of applications can be found in the chapter "Product description".

1.5 General safety instructions

The user must observe the safety instructions in this operating instructions manual, the country-specific installation standards as well as all prevailing safety regulations and accident prevention rules.



Further technical information can be found in the Elan catalogues or in the online catalogue on the Internet: www.schmersal.net.

The information contained in this operating instructions manual is provided without liability and is subject to technical modifications.

There are no residual risks, provided that the safety instructions as well as the instructions regarding mounting, commissioning, operation and maintenance are observed.

1.6 Warning about misuse



In case of inadequate or improper use or manipulations of the safety-monitoring module, personal hazards or damage to machinery or plant components cannot be excluded. The relevant requirements of the standard EN 1088 must be observed.

1.7 Exclusion of liability

We shall accept no liability for damages and malfunctions resulting from defective mounting or failure to comply with this operating instructions manual. The manufacturer shall accept no liability for damages resulting from the use of unauthorised spare parts or accessories.

For safety reasons, invasive work on the device as well as arbitrary repairs, conversions and modifications to the device are strictly forbidden; the manufacturer shall accept no liability for damages resulting from such invasive work, arbitrary repairs, conversions and/or modifications to the device.

2 Product description

2.1 Ordering code

This operating instructions manual applies to the following types:

SRB 206 ^{①-②}		
No.	Option	Description
①	ST	without cross-wire monitoring
	SQ	with cross-wire monitoring
②	24 V	24 VAC / VDC
	230 V	48 ... 230 VAC



Only if the information described in this operating instructions manual are realised correctly, the safety function and therefore the compliance with the Machinery Directive is maintained.

2.2 Special versions

For special versions, which are not listed in the order code below 2.1, these specifications apply accordingly, provided that they correspond to the standard version.

2.3 Destination and use

The safety-monitoring modules for integration in safety circuits are designed for fitting in control cabinets. They are used for the safe evaluation of the signals of positive break position switches for safety functions on sliding, hinged and removable safety guards as well as emergency stop control devices.

The safety function is defined as the opening of enabling circuits 13-14 and 23-24 when the inputs S11-S12 and/or one or more other inputs up to S112-S122 are opened. The safety-relevant current paths with the output contacts 13-14 and 23-24 meet the following requirements under observation of a B_{10d} value assessment (also refer to "Requirements of DIN EN ISO 13849-1"):

- Category 4 - PL e to DIN EN ISO 13849-1
- SIL 3 to DIN EN 61508-2
- SILCL 3 to DIN EN 62061 (meets the requirements of control category 4 to DIN EN 954-1)

To determine the Performance Level (PL) of the entire safety function (e.g. sensor, logic, actuator) to DIN EN ISO 13849-1, an analysis of all relevant components is required.

2.4 Technical data

General data:	
Standards:	IEC/EN 60204-1, EN 60947-5-1; EN ISO 13849-1, IEC/EN 61508
Climate resistance:	EN 60068-2-78
Fixing:	Snaps onto standard DIN rails to DIN EN 60715
Terminal designations:	EN 60947-1
Material of the enclosure:	glass-fibre reinforced thermoplastic, ventilated
Material of the contacts:	AgCdO, self-cleaning, positive drive
Weight:	400 g

Start conditions	Automatic or start button
Feedback circuit (Y/N):	Yes
Pull-in delay:	typ. 50 ms
Drop-out delay in case of emergency stop:	typ. 30 ms
Drop-out delay on "supply failure":	on request
Mechanical data:	
Connection type:	Screw terminals
Cable section:	min. 2 mm ² / max. 2 mm ²
Connecting cable:	rigid or flexible
Tightening torque for the terminals:	0.6 Nm
With removable terminals (Y/N):	Yes
Mechanical life:	10 million operations
Electrical life:	Derating curve available on request
Resistance to shock:	10 g / 11 ms
Resistance to vibrations to EN 60068-2-6:	10 ... 55 Hz, amplitude 0.35 mm
Ambient conditions:	
Ambient temperature:	–25°C ... +45°C
Storage and transport temperature:	–40°C ... +85°C
Protection class:	Enclosure: IP 40 Terminals: IP 20 Wiring compartment: IP 54
Air clearances and creepage distances to IEC/EN 60664-1:	4 kV/2 (basic insulation)
EMC rating:	to EMC Directive
Electrical data:	
Contact resistance in new state:	max. 100 mΩ
Power consumption:	24 V version: max. 3.6 W / 6.6 VA 230 V version: max. 6.8 VA
Rated operating voltage U _e :	24 V version: 24 VDC –15%/+20%, residual ripple max. 10% 24 VAC –15% / +10% 230 V version: 48 ... 240 VAC
Frequency range:	50 Hz / 60 Hz
Max. fuse rating of the operating voltage:	24 V version: F1: Internal electronic trip, tripping current > 1 A, Reset after disconnection of supply voltage 230 V version: primary side: fuse, tripping current > 1 A; secondary side: internal electronic fuse, tripping current > 0.12 A
Monitored inputs:	
Cross-wire detection (Y/N):	Yes (only SRB 206SQ)
Wire breakage detection (Y/N):	Yes
Earth leakage detection (Y/N):	Yes
Number of NO contacts:	0
Number of NC contacts:	2 ... 12 pc.
Cable lengths:	1,500 m with 1.5 mm ² 2,500 m with 2.5 mm ²
Conduction resistance:	max. 40 Ω
Outputs:	
Number of safety contacts:	2
Number of auxiliary contacts:	0
Number of signalling outputs:	6
Switching capacity of the safety contacts:	13-14 / 23-24: max. 250 V, 6 A ohmic (inductive in case of appropriate protective wiring)
Fuse rating of the safety contacts:	6.3 A slow blow
Utilisation category to EN 60947-5-1:	AC-15 / DC-13: EN 60947-5-1
Dimensions (H/W/D):	100 mm × 45 mm × 121 mm
The data specified in this manual is applicable when the component is operated with rated operating voltage U _e ±0%.	

2.5 Safety classification

Standards:	EN ISO 13849-1, IEC 61508, EN 60947-5-1
PL:	Stop 0: up to e
Control category:	Stop 0: up to 4 (when an individual guard door is opened)
DC:	Stop 0: 99% (high) (when an individual guard door is opened)
CCF:	> 65 points
SIL:	Stop 0: up to 3 (when an individual guard door is opened)
Service life:	20 years
B _{10d} value (for one channel):	Low voltages range 20%: 20,000,000 40%: 7,500,000 60%: 2,500,000 80%: 1,000,000 Maximum load 100%: 400,000

$$MTTF_d = \frac{B_{10d}}{0,1 \times n_{op}} \quad n_{op} = \frac{d_{op} \times h_{op} \times 3600 \text{ s/h}}{t_{cycle}}$$

For an average annual demand rate of $n_{op} = 126,720$ cycles per year, Performance Level PL e can be obtained at maximum load.

n_{op} = average number of activations per year
 d_{op} = average number of operating days per year
 h_{op} = average number of operating hours per day
 t_{cycle} = average demand rate of the safety function in s
 (e.g. 4 × per hour = 1 × per 15 min. = 900 s)

(Specifications can vary depending on the application-specific parameters h_{op} , d_{op} and t_{cycle} as well as the load.)

3 Mounting

3.1 General mounting instructions

Mounting: snaps onto standard DIN rails to EN 60715.

Snap the bottom of the enclosure slightly tilted forwards in the DIN rail and push up until it latches in position.

3.2 Dimensions

All measurements in mm.

Device dimensions (H/W/D): 100 x 45 x 121 mm
 with plugged-in terminals: 120 x 45 x 121 mm

4 Electrical connection

4.1 General information for electrical connection



The electrical connection may only be carried out by authorised personnel in a de-energised condition.

Wiring examples: see appendix

5 Operating principle and settings

5.1 LED functions

- K1: Status channel 1
- K2: Status channel 2
- U_B: Status operating voltage (LED is on, when the operating voltage on the terminals A1-A2 is ON)
- U_i: Status internal operating voltage (LED is on, when the operating voltage on the terminals A1-A2 is ON and the fuse has not been triggered)

5.2 Description of the terminals

Voltages:	A1	+24 VDC / 24 VAC / 48 ... 230 VAC
	A2	0 VDC / 24 VAC / 48 ... 230 VAC
Inputs:		refer to 8.3 Sensor configuration
Outputs:	13-14	First safety enabling circuit (stop 0)
	23-24	Second safety enabling circuit (stop 0)
Feedback circuit:	X1-X3	Automatic start
Start:	X1-X2	Manual start (reset button, monitored)
Signalling output:	41-42	Auxiliary contact

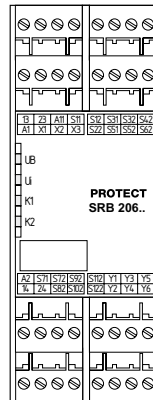

Fig. 1

6 Set-up and maintenance

6.1 Functional testing

The safety function of the safety-monitoring module must be tested. The following conditions must be previously checked and met:

1. Correct fixing
2. Check the integrity of the cable entry and connections
3. Check the safety-monitoring module's enclosure for damage.
4. Check the electrical function of the connected sensors and their influence on the safety-monitoring module and the downstream actuators

6.2 Maintenance

A regular visual inspection and functional test, including the following steps, is recommended:

1. Check the correct fixing of the safety-monitoring module
2. Check the cable for damages
3. Check electrical function

Damaged or defective components must be replaced.

7 Disassembly and disposal

7.1 Disassembly

The safety-monitoring module must be disassembled in a de-energised condition only.

7.2 Disposal

The safety-monitoring module must be disposed of in an appropriate manner in accordance with the national prescriptions and legislations.

8 Appendix

8.1 Wiring examples

Dual-channel control, shown for a guard door monitor; with two contacts, where at least one is a positive break contact; with external reset button [®]

- Relay outputs: Suitable for 2-channel control, for increase in capacity or number of contacts by means of contactors or relays with positive-guided contacts.
- The control system recognises wire breakage, earth faults (and cross-wire shorts in the SQ version) in the guard monitoring circuits.
- [®] = Feedback circuit

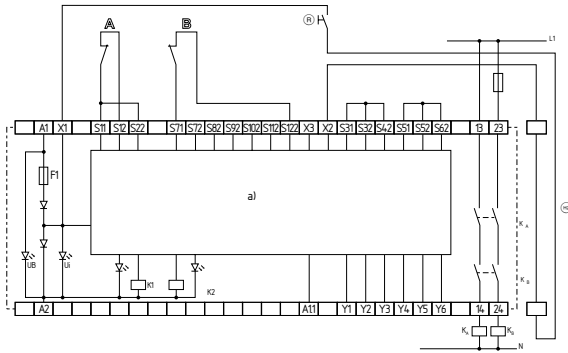

Fig. 2
a) Logic

8.2 Start configuration

Automatic start (see Fig. 3)

- If the feedback circuit is not required, establish a bridge.
- When the safety-monitoring module is used with the operating mode "Automatic start", an automatic restart after a shutdown in case of emergency must be prevented by the upstream control to EN 60204-1 paragraph 9.2.5.4.2 and 10.8.3.

External reset button (monitored) (Fig. 4)

- The external reset button is wired to the terminals X1-X2.
- The safety-monitoring module is activated by the reset (after release) of the reset button (= detection of the falling edge). Faults in the reset button, e.g. welded contacts or manipulations which could lead to an inadvertent restart, are detected in this configuration and will result in an inhibition of the operation.
- The external reset button is integrated in the feedback circuit in series.

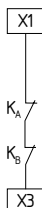

Fig. 3

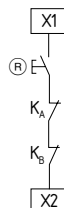

Fig. 4

8.3 Sensor configuration

Sixfold emergency stop circuit to EN 418/EN 60947-5-5 (Fig. 5 a-f)

- Dual-channel control
- This control system recognises earth faults (only SRB 206ST-24V and SRB 206SQ-24V) and wire breakage in the control circuits.
- Cross-wire shorts between the control circuits are detected (only SRB 206SQ-24V and SRB 206SQ-230V).
- In case of a partial assignment (less than 6 sensors connected) also refer to the table below with the then required bridges.

Connection of 1 emergency stop circuit:		Bridges:
NC contact 1	S11-S12	S11 / S22 / S31 / S32 / S42 / S51 / S52 / S62
NC contact 2	S71-S122	S52 / S62
Connection of 2 emergency stop circuits:		Bridges:
NC contact 1	S11-S12	S31 / S32 / S42 / S51 / S52 / S62
NC contact 2	S71-S72	
NC contact 3	S11-S22	
NC contact 4	S72-S122	
Connection of 3 emergency stop circuits:		Bridges:
NC contact 1	S11-S12	S31 / S42 / S51 / S52 / S62
NC contact 2	S71-S72	
NC contact 3	S11-S22	
NC contact 4	S72-S82	
NC contact 5	S31-S32	
NC contact 6	S82-S122	
Connection of 4 emergency stop circuits:		Bridges:
NC contact 1	S11-S12	S51 / S52 / S62
NC contact 2	S71-S72	
NC contact 3	S11-S22	
NC contact 4	S72-S82	
NC contact 5	S31-S32	
NC contact 6	S82-S92	
NC contact 7	S31-S42	
NC contact 8	S92-S122	
Connection of 5 emergency stop circuits:		Bridges:
NC contact 1	S11-S12	S51 / S62
NC contact 2	S71-S72	
NC contact 3	S11-S22	
NC contact 4	S72-S82	
NC contact 5	S31-S32	
NC contact 6	S82-S92	
NC contact 7	S31-S42	
NC contact 8	S92-S102	
NC contact 9	S51-S52	
NC contact 10	S102-S122	
Connection of 6 emergency stop circuits:		Bridges:
NC contact 1	S11-S12	None
NC contact 2	S71-S72	
NC contact 3	S11-S22	
NC contact 4	S72-S82	
NC contact 5	S31-S32	
NC contact 6	S82-S92	
NC contact 7	S41-S42	
NC contact 8	S92-S102	
NC contact 9	S51-S52	
NC contact 10	S102-S112	
NC contact 11	S51-S62	
NC contact 12	S112-S122	

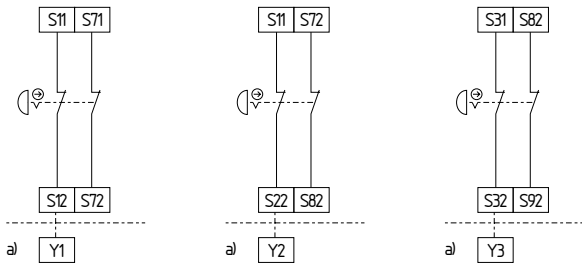

Fig. 5a a) Signalling outputs
Fig. 5b a) Signalling outputs
Fig. 5c a) Signalling outputs

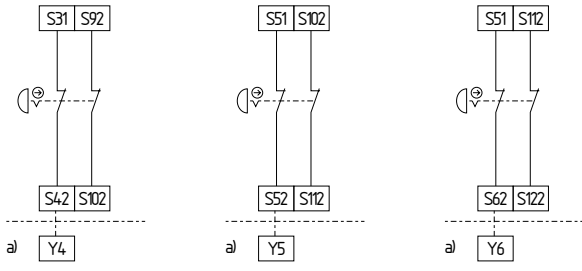

Fig. 5d a) Signalling outputs
Fig. 5e a) Signalling outputs
Fig. 5f a) Signalling outputs

Sixfold guard door monitoring to EN 1088 with at least one positive break position switch (Fig. 6 a-f)

- Dual-channel control
- This control system recognises earth faults (only SRB 206ST-24V and SRB 206SQ-24V) and wire breakage in the control circuits.
- Cross-wire shorts between the control circuits are detected (only SRB 206SQ-24V and SRB 206SQ-230V).
- In case of a partial assignment (less than 6 sensors connected) also refer to the table below with the then required bridges.

Connection of 1 safety guard:		Bridges:
NC contact 1	S11-S12	S11 / S22 / S31 / S32 / S42 / S51 / S52 / S62
NC contact 2	S71-S122	
Connection of 2 safety guards:		Bridges:
NC contact 1	S11-S12	S31 / S32 / S42 / S51 / S52 / S62
NC contact 2	S71-S72	
NC contact 3	S11-S22	
NC contact 4	S72-S122	
Connection of 3 safety guards:		Bridges:
NC contact 1	S11-S12	S31 / S42 / S51 / S52 / S62
NC contact 2	S71-S72	
NC contact 3	S11-S22	
NC contact 4	S72-S82	
NC contact 5	S31-S32	
NC contact 6	S82-S122	
Connection of 4 safety guards:		Bridges:

NC contact 1	S11-S12	S51 / S52 / S62
NC contact 2	S71-S72	
NC contact 3	S11-S22	
NC contact 4	S72-S82	
NC contact 5	S31-S32	
NC contact 6	S82-S92	
NC contact 7	S31-S42	
NC contact 8	S92-S122	

Connection of 5 safety guards: Bridges:

NC contact 1	S11-S12	S51 / S62
NC contact 2	S71-S72	
NC contact 3	S11-S22	
NC contact 4	S72-S82	
NC contact 5	S31-S32	
NC contact 6	S82-S92	
NC contact 7	S31-S42	
NC contact 8	S92-S102	
NC contact 9	S51-S52	
NC contact 10	S102-S122	

Connection of 6 safety guards: Bridges:

NC contact 1	S11-S12	None
NC contact 2	S71-S72	
NC contact 3	S11-S22	
NC contact 4	S72-S82	
NC contact 5	S31-S32	
NC contact 6	S82-S92	
NC contact 7	S41-S42	
NC contact 8	S92-S102	
NC contact 9	S51-S52	
NC contact 10	S102-S112	
NC contact 11	S51-S62	
NC contact 12	S112-S122	

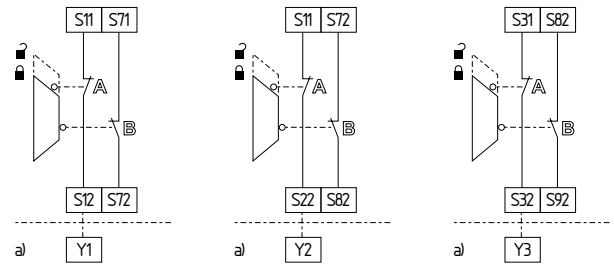

Fig. 6a a) Signalling outputs
Fig. 6b a) Signalling outputs
Fig. 6c a) Signalling outputs

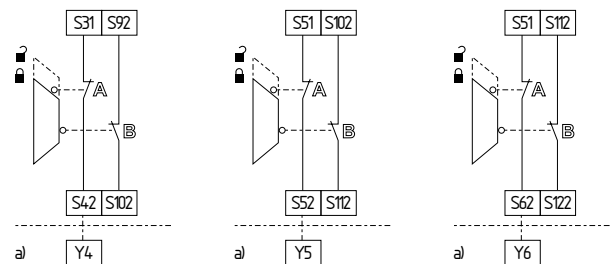

Fig. 6d a) Signalling outputs
Fig. 6e a) Signalling outputs
Fig. 6f a) Signalling outputs

Sixfold guard door monitoring to EN 1088 with one positive break position switch (only possible with version SRB 206ST-24V / -230V (Fig. 7 a-f)

- Single-channel control, refer to the table below for the status of the signalling outputs Y1...Y6.
- The control system recognises wire-breakage and earth faults in the control circuit.
- In case of a partial assignment (less than 6 sensors connected) also refer to the table below with the then required bridges.

Connection of 1 safety guard: Bridges:		
NC contact 1	S71-S72	S72 / S12 / S22 / S32 / S42 / S52 / S62 / S122
Connection of 2 safety guards: Bridges:		
NC contact 1	S71-S12	S12-S72 / S82 / S22 / S32 / S42 / S52 / S62 / S122
NC contact 2	S72-S82	S52 / S62 / S122
Connection of 3 safety guards: Bridges:		
NC contact 1	S71-S12	S12-S72 / S22-S82 / S92 / S32 / S42 / S52 / S62 / S122
NC contact 2	S72-S22	S42 / S52 / S62 / S122
NC contact 3	S82-S92	
Connection of 4 safety guards: Bridges:		
NC contact 1	S71-S12	S12-S72 / S22-S82 / S32-S92 / S102 / S42 / S52 / S62 / S122
NC contact 2	S72-S22	S102 / S42 / S52 / S62 / S122
NC contact 3	S82-S32	
NC contact 4	S92-S102	
Connection of 5 safety guards: Bridges:		
NC contact 1	S71-S12	S12-S72 / S22-S82 / S32-S92 / S42-S102 / S112-S52 / S62-S122
NC contact 2	S72-S22	S42-S102 / S112-S52 / S62-S122
NC contact 3	S82-S32	
NC contact 4	S92-S42	
NC contact 5	S102-S112	
Connection of 6 safety guards: Bridges:		
NC contact 1	S71-S12	S12-S72 / S22-S82 / S32-S92 / S42-S102 / S112-S52 / S62-S122
NC contact 2	S72-S22	S42-S102 / S112-S52 / S62-S122
NC contact 3	S82-S32	
NC contact 4	S92-S42	
NC contact 5	S102-S52	
NC contact 6	S112-S62	

Y1	Y2	Y3	Y4	Y5	Y6	Status
1	1	1	1	1	1	All guards closed
1	1	1	1	1	0	Guard 6 open
1	1	1	1	0	0	Guard 5 open
1	1	1	0	0	0	Guard 4 open
1	1	0	0	0	0	Guard 3 open
1	0	0	0	0	0	Guard 2 open
0	0	0	0	0	0	Guard 1 open

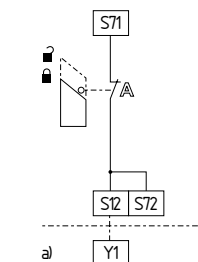

Fig. 7a
a) Signalling outputs

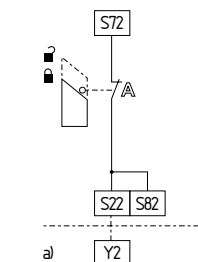

Fig. 7b
a) Signalling outputs

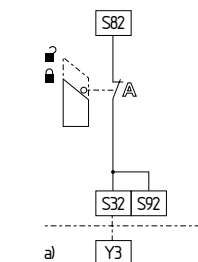

Fig. 7c
a) Signalling outputs

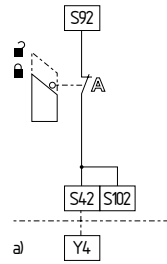

Fig. 7d
a) Signalling outputs

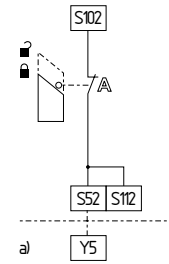

Fig. 7e
a) Signalling outputs

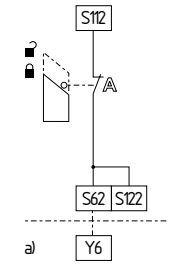

Fig. 7f
a) Signalling outputs

Sixfold emergency stop circuit to EN 418/EN 60947-5-5 (only possible with version SRB 206ST-24V / -230V (Fig. 8 a-f))

- Single-channel control
- The control system recognises wire-breakage and earth faults in the control circuit.
- In case of a partial assignment (less than 6 sensors connected) also refer to the table below with the then required bridges.

Connection of 1 emergency stop circuit: Bridges:		
NC contact 1	S71-S72	S72 / S12 / S22 / S32 / S42 / S52 / S62 / S122
Connection of 2 emergency stop circuits: Bridges:		
NC contact 1	S71-S12	S12-S72 / S82 / S22 / S32 / S42 / S52 / S62 / S122
NC contact 2	S72-S82	S52 / S62 / S122
Connection of 3 emergency stop circuits: Bridges:		
NC contact 1	S71-S12	S12-S72 / S22-S82 / S92 / S32 / S42 / S52 / S62 / S122
NC contact 2	S72-S22	S42 / S52 / S62 / S122
NC contact 3	S82-S92	
Connection of 4 emergency stop circuits: Bridges:		
NC contact 1	S71-S12	S12-S72 / S22-S82 / S32-S92 / S102 / S42 / S52 / S62 / S122
NC contact 2	S72-S22	S102 / S42 / S52 / S62 / S122
NC contact 3	S82-S32	
NC contact 4	S92-S102	
Connection of 5 emergency stop circuits: Bridges:		
NC contact 1	S71-S12	S12-S72 / S22-S82 / S32-S92 / S42-S102 / S112-S52 / S62-S122
NC contact 2	S72-S22	S42-S102 / S112-S52 / S62-S122
NC contact 3	S82-S32	
NC contact 4	S92-S42	
NC contact 5	S102-S112	
Connection of 6 emergency stop circuits: Bridges:		
NC contact 1	S71-S12	S12-S72 / S22-S82 / S32-S92 / S42-S102 / S112-S52 / S62-S122
NC contact 2	S72-S22	S42-S102 / S112-S52 / S62-S122
NC contact 3	S82-S32	
NC contact 4	S92-S42	
NC contact 5	S102-S52	
NC contact 6	S112-S62	

Y1	Y2	Y3	Y4	Y5	Y6	Status
1	1	1	1	1	1	No emergency stop actuated
1	1	1	1	1	0	Emergency stop 6 actuated
1	1	1	1	0	0	Emergency stop 5 actuated
1	1	1	0	0	0	Emergency stop 4 actuated
1	1	0	0	0	0	Emergency stop 3 actuated
1	0	0	0	0	0	Emergency stop 2 actuated
0	0	0	0	0	0	Emergency stop 1 actuated

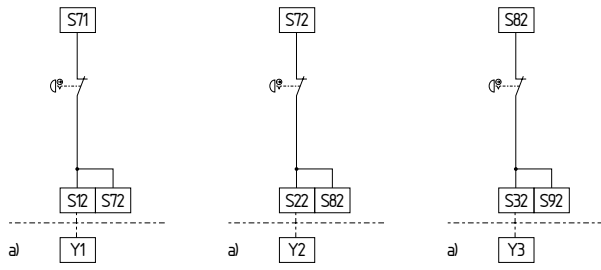

Fig. 8a a) Signalling outputs
Fig. 8b a) Signalling outputs
Fig. 8c a) Signalling outputs

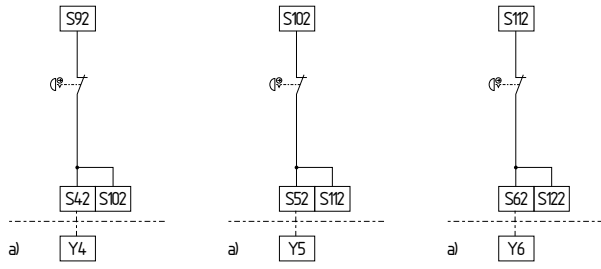

Fig. 8d a) Signalling outputs
Fig. 8e a) Signalling outputs
Fig. 8f a) Signalling outputs

Notes:

- Max. control category 4 to EN 954-1 (when an individual emergency stop or guard door circuit is opened). To control the risk of error accumulation, which is especially required in control category 4, we recommend regularly checking the circuit by means of a start-up test.
- Max. control category 3 to EN 954-1 (when multiple guard door or emergency stop circuits are simultaneously opened).
- An individual fault of the sensors does not lead to the safety function to be lost.
- If the single failure occurs, the safety function will be maintained. Some, although not all, errors will be recognised. An accumulation of unrecognised errors could cause the safety function to be lost.

Wiring example signalling output (Fig. 9)

- Visualisation of the door position by external LED indications at the signalling outputs Y1-Y6
- When the safety guard is closed, the signalling output is supplied with 24V.



Do not use the signalling outputs for safety circuits!

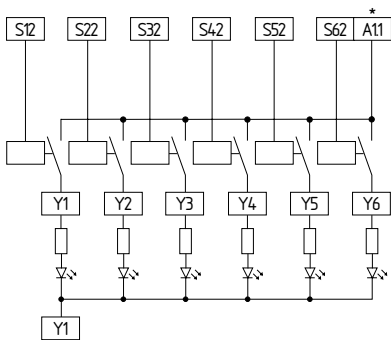

Fig. 9
* = 24 VDC external

8.4 Actuator configuration

Single-channel control (see Fig. 10)

- Suitable for increase in capacity or number of contacts by means of contactors or relays with positive-guided contacts.
- \ominus = feedback circuit:
If the feedback circuit is not required, establish a bridge.

Dual-channel control with feedback circuit (Fig. 11)

- Suitable for increase in capacity or number of contacts by means of contactors or relays with positive-guided contacts.
- \ominus = feedback circuit: If the feedback circuit is not required, establish a bridge.

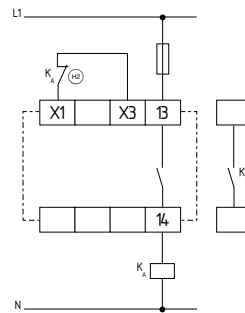

Fig. 10

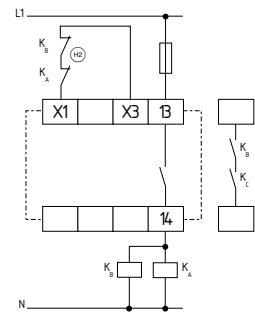



Fig. 11

8.5 EC Declaration of conformity

	
<h2>EC Declaration of conformity</h2>	
Translation of the original declaration of conformity valid as of December 29, 2009	Elan Schaltelemente GmbH & Co. KG Im Ostpark 2 · 35435 Wettenberg Germany Internet: www.elan.de
We hereby certify that the hereafter described safety components both in its basic design and construction conform to the applicable European Directives.	
Name of the safety component:	SRB 206ST SRB 206SQ
Description of the safety component:	Safety-monitoring module for emergency stop circuits and guard door monitoring
Harmonised EC-Directives:	2006/42/EC EC-Machinery Directive 2004/108/EC EMC-Directive
Person authorized for the compilation of the technical documentation:	Ulrich Loss Möddinghofe 30 42279 Wuppertal
Notified body, which approved the full quality assurance system, referred to in Appendix X, 2006/42/EC:	TÜV Rheinland Industrie Service GmbH Alboinstraße 56 12103 Berlin ID n°: 0035
Place and date of issue:	Wuppertal, October 6, 2009
SRB206ST_SQ-B-EN	
	Authorised signature Heinz Schmersal Managing Director



Note

The currently valid declaration of conformity can be downloaded from the internet at www.schmersal.net.



Elan Schaltelemente GmbH & Co. KG
Im Ostpark 2, D - 35435 Wettenberg
Postfach 1109, D - 35429 Wettenberg

Telefon: +49 (0)641 9848-0
Telefax: +49 (0)641 9848-420
E-Mail: info-elan@schmersal.com
Internet: www.elan.de