



EN Operating instructions.pages 1 to 6
Translation of the original operating instructions

Content

1 About this document

1.1 Function 1

1.2 Target group: authorised qualified personnel. 1

1.3 Explanation of the symbols used 1

1.4 Appropriate use 1

1.5 General safety instructions 1

1.6 Warning about misuse 2

1.7 Exclusion of liability 2

2 Product description

2.1 Ordering code 2

2.2 Special versions. 2

2.3 Destination and use 2

2.4 Technical data 2

2.5 Safety classification 3

3 Mounting

3.1 General mounting instructions 3

3.2 Dimensions 3

4 Electrical connection

4.1 General information for electrical connection. 3

5 Operating principle and settings

5.1 LED functions. 3

5.2 Description of the terminals 3

6 Set-up and maintenance

6.1 Functional testing. 3

6.2 Maintenance 4

7 Disassembly and disposal

7.1 Disassembly. 4

7.2 Disposal 4

8 Appendix

8.1 Wiring examples 4

8.2 Sensor configuration 4

8.3 Actuator configuration 5

9 Declaration of conformity

9.1 EC Declaration of conformity 6

1. About this document

1.1 Function

This operating instructions manual provides all the information you need for the mounting, set-up and commissioning for the safe operation and disassembly of the input expander module. The operating instructions must be available in a legible condition and a complete version in the vicinity of the device.

1.2 Target group: authorised qualified personnel

All operations described in this operating instructions manual must be carried out by trained specialist personnel, authorised by the plant operator only.

Please make sure that you have read and understood these operating instructions and that you know all applicable legislations regarding occupational safety and accident prevention prior to installation and putting the component into operation.

The machine builder must carefully select the harmonised standards to be complied with as well as other technical specifications for the selection, mounting and integration of the components.

1.3 Explanation of the symbols used



Information, hint, note:

This symbol is used for identifying useful additional information.



Caution: Failure to comply with this warning notice could lead to failures or malfunctions.

Warning: Failure to comply with this warning notice could lead to physical injury and/or damage to the machine.

1.4 Appropriate use

The products described in these operating instructions are developed to execute safety-related functions as part of an entire plant or machine. It is the responsibility of the manufacturer of a machine or plant to ensure the correct functionality of the entire machinery or plant.

The input expander module must be exclusively used in accordance with the versions listed below or for the applications authorised by the manufacturer. Detailed information regarding the range of applications can be found in the chapter "Product description".



To avoid EMC disturbances, the physical ambient and operational conditions at the place where the product is installed, must meet the provisions laid down in the paragraph "Electromagnetic Compatibility (EMC)" of DIN EN 60204-1.

1.5 General safety instructions

The user must observe the safety instructions in this operating instructions manual, the country-specific installation standards as well as all prevailing safety regulations and accident prevention rules.



Further technical information can be found in the online catalogue on the Internet: www.schmersal.net.

The information contained in this operating instructions manual is provided without liability and is subject to technical modifications.



If multiple safety components are wired in series, the Performance Level to EN ISO 13849-1 will be reduced due to the restricted error detection under certain circumstances. The entire concept of the control system, in which the safety component is integrated, must be validated to EN ISO 13849-2.

There are no residual risks, provided that the safety instructions as well as the instructions regarding mounting, commissioning, operation and maintenance are observed.

1.6 Warning about misuse



In case of inadequate or improper use or manipulations of the component, personal hazards or damage to machinery or plant components cannot be excluded. The relevant requirements of the standards EN 1088 and EN ISO 13850 must be observed.

1.7 Exclusion of liability

We shall accept no liability for damages and malfunctions resulting from defective mounting or failure to comply with this operating instructions manual. The manufacturer shall accept no liability for damages resulting from the use of unauthorised spare parts or accessories.

For safety reasons, invasive work on the device as well as arbitrary repairs, conversions and modifications to the device are strictly forbidden; the manufacturer shall accept no liability for damages resulting from such invasive work, arbitrary repairs, conversions and/or modifications to the device.

2. Product description

2.1 Ordering code

This operating instructions manual applies to the following types:

PROTECT-IE^{①-②}

No.	Option	Description
①	02	Connection of NC/NC sensors
	11	Connection of NC/NO sensors with cage clamps
②	SK	with plug-in screw connection



- Possibility to connect up to 4 sensors per interface, e.g. safety magnetic switches of the BNS type, emergency stop control devices, interlocking devices, etc.
- Current and voltage limitation of the input circuits
- Cross-wire monitoring of the input circuits
- Signalling output for each sensor (monitoring of both circuits of the sensors)
- Green LED indications for UB and every sensor contact
- Cascading possible for the connection of up to 80 sensors



This device is designed as input expander module. The safety function is only realised in conjunction with the downstream basic device (SRB). To this effect, the device must be connected in accordance with the wiring example!



Only if the information described in this operating instructions manual are realised correctly, the safety function and therefore the compliance with the Machinery Directive is maintained.

2.2 Special versions

For special versions, which are not listed in the order code below 2.1, these specifications apply accordingly, provided that they correspond to the standard version.

2.3 Destination and use

The input expander modules for integration in safety circuits are designed for fitting in control cabinets. They are used for the evaluation of the signals of 1...4 sensors and the summarised transmission of the signals to a downstream safety-monitoring module.

The function is defined as the opening of the enabling contacts 13-14 and 23-24 when one or more of the 8 sensor inputs are actuated. The enabling paths with the outputs contacts 13-14 and 23-24 meet the following requirements under observation of a PFH value assessment and in conjunction with an SRB (control category 4 / PLe) (also refer to chapter 2.5 "Safety classification"):

- Control category 3 – PL d to EN ISO 13849-1 (when multiple safety guards are opened within one work cycle)
- SIL 2 to IEC 61508
- SILCL 2 to EN 62061

refer to folder:

http://www.schmersal.net/Bilddata/broschue/k-info/i_diap01.pdf (german)

http://www.schmersal.net/Bilddata/broschue/k-info/i_diap02.pdf (english)



The above-described requirements cannot be met by the input expander module solely, but only in combination with a safety-monitoring module as described in this manual.

To determine the Performance Level (PL) to EN ISO 13849-1 of the entire safety function (e.g. sensor, logic, actuator), an assessment of all relevant components is required.

2.4 Technical data

General data:

Standards: IEC/EN 60204-1, EN 60947-5-1; EN ISO 13849-1, IEC/EN 61508

Climate resistance: EN 60068-2-78

Mounting: Snaps onto standard DIN rail to EN 60715

Terminal designations: EN 60947-1

Material of the housings: thermoplastic plastic

Material of the contacts: AgNi

Weight: 140 g

Start conditions: Automatic

Feedback circuit (Y/N): No

Pull-in delay: ≤ 20 ms

Drop-out delay: ≤ 20 ms

Mechanical data:

Connection type: Cage clamps;

- SK variant: plug-in screw connection

Cable section:

- Cage clamps: min. 0.08 mm² / max. 2.5 mm²

- Screw connection: min. 0.14 mm² / max. 1.5 mm²

Connecting cable: rigid or flexible

Tightening torque for the terminals: 0.6 Nm

With removable terminals (Y/N): No;

SK variant: Yes

Mechanical life: 10 million operations

Electrical life: Derating curve available on request

Resistance to shock: 30 g / 11 ms

Resistance to vibrations to EN 60068-2-6: 10 ... 55 Hz,

amplitude 0.35 mm

Ambient conditions:

Ambient temperature: -25 °C ... +55 °C

Storage and transport temperature: -40 °C ... +85 °C

Protection class: IP20

Air clearances and creepage

distances to IEC/EN 60664-1: 800 V/2 (basic insulation)

EMC rating: to EMC Directive

Electrical data:

Contact resistance in new state: max. 100 mΩ

Power consumption: max. max. 1.7 W plus Y1-Y4

Rated operating voltage U_e: 24 VDC -15% / +20%,

residual ripple max. 10%

Fuse rating for the operating voltage: Internal electronic trip,

tripping current > 100 mA

Monitored inputs:

Cross-wire detection (Y/N):	Yes
Wire breakage detection (Y/N):	Yes
Earth leakage detection (Y/N):	Yes
Number of NO contacts:	variant 02: 0; variant 11: 4
Number of NC contacts:	variant 02: 8; variant 11: 4
Conduction resistance:	max. 40 Ω

Outputs:

Number of enabling paths:	2
Number of auxiliary contacts:	0
Number of signalling outputs:	4
Switching capacity of the enabling paths:	13-14; 23-24: max. 24 V / 2 A ohmic (inductive with suitable protective circuit); min. 10 V / 10 mA

Recommended fuse for the enabling paths:	2 A slow blow
Switching capacity of the signalling outputs: Y1 ... Y4:	24 VDC / 100 mA
Dimensions H x W x D:	126 mm x 48 mm x 61 mm

The data specified in this manual is applicable when the component is operated with rated operating voltage $U_e \pm 0\%$.

2.5 Safety classification

Standards:	EN ISO 13849-1, IEC 61508
PL:	STOP 0: up to d
Category:	STOP 0: up to 3
DC:	STOP 0: > 60 % (low)
CCF:	> 65 points
PFH value:	STOP 0: $2.00 \times 10^{-7}/h$
SIL:	STOP 0: up to 2
Service life:	20 years

The PFH value of $2.00 \times 10^{-7}/h$ applies to the combinations of contact load (current through enabling contacts) and number of switching cycles (n_{oply}) mentioned in the table below. At 365 operating days per year and a 24-hours operation, this results in the below-mentioned switching cycle times (t_{cycle}) for the relay contacts.

Diverging applications upon request.

Contact load	n_{oply}	t_{cycle}
20 %	525,600	1.0 min
40 %	210,240	2.5 min
60 %	75,087	7.0 min
80 %	30,918	17.0 min
100 %	12,223	43.0 min



The above-described requirements cannot be met by the input expander module solely, but only in combination with a safety-monitoring module as described in this manual.

3. Mounting

3.1 General mounting instructions

Mounting: snaps onto standard DIN rails to EN 60715.

Snap the bottom of the enclosure slightly tilted backwards in the DIN rail and push down until it latches in position.

3.2 Dimensions

All measurements in mm.

Device dimensions (H/W/D): 126 × 48 × 61 mm
with plug-in terminals: 126 × 48 × 53 mm

4. Electrical connection

4.1 General information for electrical connection



As far as the electrical safety is concerned, the protection against unintentional contact of the connected and therefore electrically interconnected apparatus and the insulation of the feed cables must be designed for the highest voltage, which can occur in the device.



The electrical connection may only be carried out by authorised personnel in a de-energised condition.

Wiring examples: see appendix

5. Operating principle and settings

5.1 LED functions

- U_B : Status operating voltage (LED is on, when the operating voltage on the terminals is ON)
- Y1...Y4: Status of the inputs S1...S8 (LED is on, when the allocated input circuit is opened)

5.2 Description of the terminals

Voltages:	A1	+24 VDC
	A2	0 VDC
	+	24 VDC
	-	0 VDC
	S1 ... S8	+24 VDC / 0 VDC
Outputs:	13-14	1. Enabling circuit
	23-24	2. Enabling circuit
Start:	Y1 ... Y4	Status of the inputs (+24 V, when the allocated input circuit is opened)

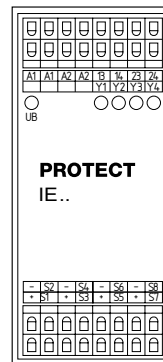

Fig. 1



Signalling outputs must not be used in safety circuits.

6. Set-up and maintenance

6.1 Functional testing

The function of the component must be tested. The following conditions must be previously checked and met:

1. Correct fixing
2. Check the integrity of the cable entry and connections
3. Check the switch enclosure for damage
4. Check the electrical function of the connected sensor technology and their influence on the safety-monitoring module and the downstream actuators

6.2 Maintenance

A regular visual inspection and functional test, including the following steps, is recommended:

1. Check the correct fixing of the input expander module
2. Check the cable for damages
3. Check electrical function



The device has to be integrated into the periodic check-ups according to the Ordinance on Industrial Safety and Health, however at least 1x/year.

Damaged or defective components must be replaced.

7. Disassembly and disposal

7.1 Disassembly



The input expander module must be disassembled in the de-energised condition only.

Insert a screwdriver at the marked position, press in the direction of the cover and remove.

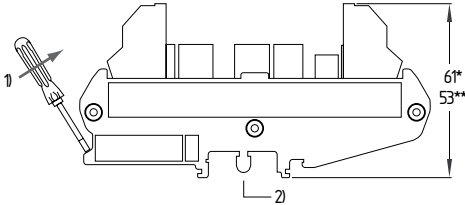

Fig. 6:

- 1) Disassembly;
 - 2) DIN rail system to EN 60715;
- * with cage clamps;
** with plug-in terminals (representation of the standard version PROTECT-IE-11)

7.2 Disposal

The input expander module must be disposed of in an appropriate manner in accordance with the national prescriptions and legislations.

8. Appendix

8.1 Wiring examples

- Start level: Depends on the wiring of the safety relay module
- Sensor level: Dual-channel control of magnetic safety sensors to IEC 60947-5-3
- Output level: dual-channel control of a downstream safety-monitoring module

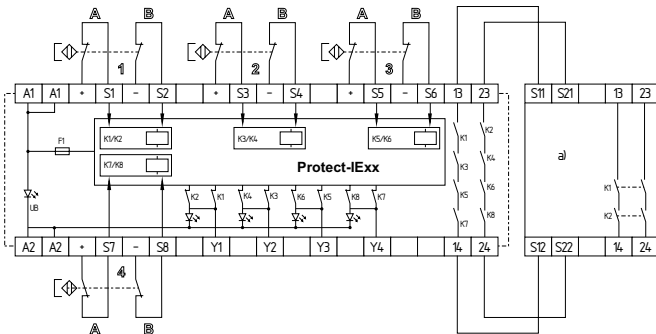

Fig. 3

a) Safety-monitoring module, e.g. SRB 301MC, SRB 301ST, SRB 211ST

8.2 Sensor configuration

Dual-channel control of magnetic safety sensors to IEC 60947-5-3 (see Fig. 4)

- The control system recognises wire breakage and earth faults in the control circuit.
- Cross-wire shorts between the monitoring circuits are detected.
- If the inputs S1, S3, S5 and S7 are not used, they have to be bridged to +.
- If the inputs S2, S4, S6 and S8 are not used, they have to be bridged to -.

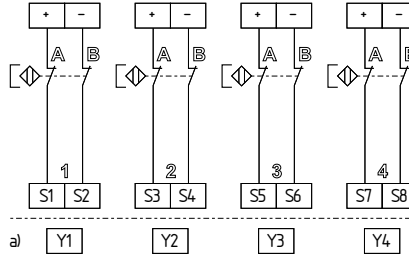

Fig. 4 a) signal outputs

Dual-channel emergency stop circuit to EN ISO 13850 and EN 60947-5-5 (Fig. 5)

- The control system recognises wire breakage and earth faults in the control circuit.
- Cross-wire shorts between the monitoring circuits are detected.
- If the inputs S1, S3, S5 and S7 are not used, they have to be bridged to +.
- If the inputs S2, S4, S6 and S8 are not used, they have to be bridged to -.

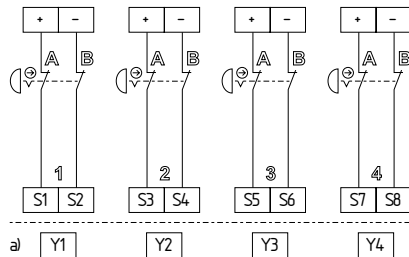

Fig. 5 a) signal outputs

Dual-channel guard door monitoring to EN 1088 (Fig. 6)

- The control system recognises wire breakage and earth faults in the control circuit.
- Cross-wire shorts between the monitoring circuits are detected.
- If the inputs S1, S3, S5 and S7 are not used, they have to be bridged to +.
- If the inputs S2, S4, S6 and S8 are not used, they have to be bridged to -.

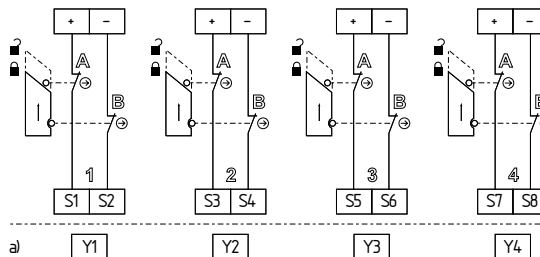

Fig. 6 a) signal outputs

Dual-channel antivolt control of magnetic safety sensors to IEC 60947-5-3 (see Fig. 7)

- The control system recognises wire breakage and earth faults in the control circuit.
- Cross-wire shorts between the monitoring circuits are detected.
- If the inputs S1, S3, S5 and S7 are not used, they have to be bridged to +.
- The unused inputs S2, S4, S6 and S8 remain vacant.

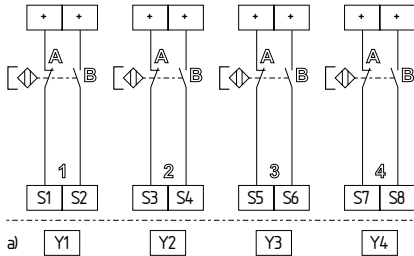

Fig. 7 a) signal outputs

Dual-channel antivolt control of an emergency stop circuit to EN ISO 13850 and EN 60947-5-5 (Fig. 8)

- The control system recognises wire breakage and earth faults in the control circuit.
- Cross-wire shorts between the monitoring circuits are detected.
- If the inputs S1, S3, S5 and S7 are not used, they have to be bridged to +.
- The unused inputs S2, S4, S6 and S8 remain vacant.

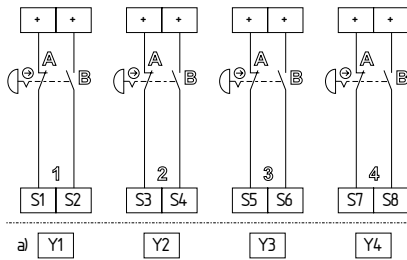

Fig. 8 a) signal outputs

Dual-channel antivolt control of a guard door monitoring EN 1088 (Fig. 9)

- The control system recognises wire breakage and earth faults in the control circuit.
- Cross-wire shorts between the monitoring circuits are detected.
- If the inputs S1, S3, S5 and S7 are not used, they have to be bridged to +.
- The unused inputs S2, S4, S6 and S8 remain vacant.

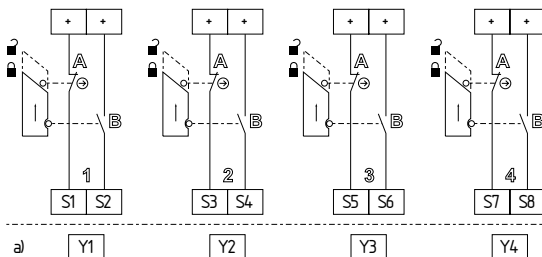

Fig. 9 a) signal outputs

8.3 Actuator configuration

Enabling circuits (Fig. 10)

- All safety-monitoring modules with control category 4 or PLe from the Schmersal Group with current < 1 A in the monitoring circuit can be connected to the Protect-IE-02 and Protect-IE-11 devices.

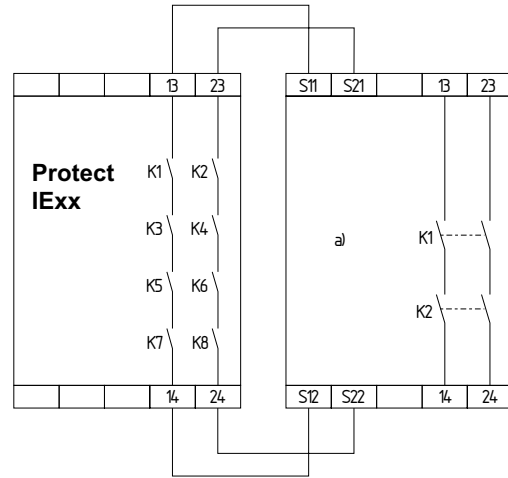

Fig. 10

a) Safety-monitoring module, e.g. SRB 301MC, SRB 301ST, SRB 211ST



The safety-monitoring modules must be suitable for the signal processing of single- or dual-channel potential-free NC contacts. The start and actuator configuration must be set up in accordance with the datasheet.

Signalling outputs (see fig. 11)

- The LED's or the signal outputs indicate that the safety guard or the emergency stop circuit is opened.
- Both contact circuits of a sensor are monitored.
- If the safety guard or the emergency stop circuit is opened, a 24V signal is activated at the output concerned (Y1...Y4) and the allocated LED is lit.

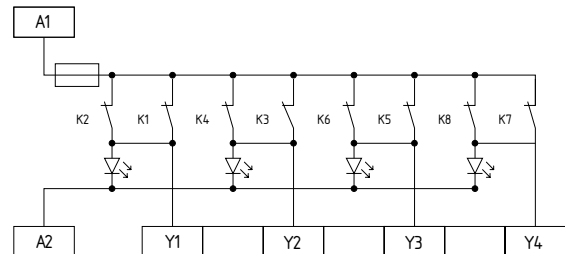

Fig. 11

Cascading (Fig. 12)

- In this way, up to 20 components can be wired in series. This corresponds to a signal processing of up to 80 sensors.

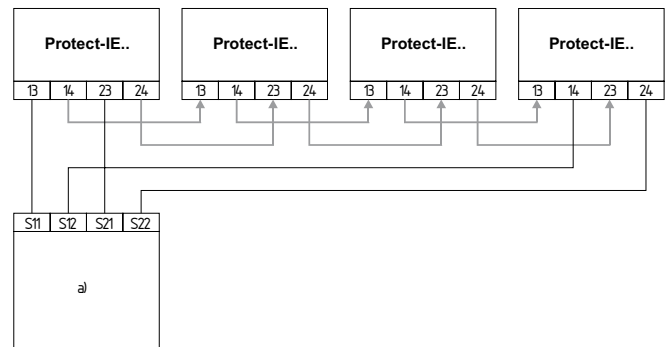

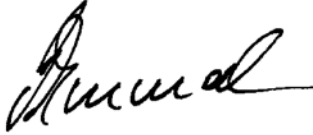

Fig. 12

a) Safety-monitoring module, e.g. SRB 301MC, SRB 301ST, SRB 211ST

9. Declaration of conformity

9.1 EC Declaration of conformity

	
<h2>EC Declaration of conformity</h2>	
Translation of the original declaration of conformity	K.A. Schmersal GmbH & Co. KG Industrielle Sicherheitssysteme Möddinghofe 30, 42279 Wuppertal Germany Internet: www.schmersal.com
We hereby certify that the hereafter described safety components both in its basic design and construction conform to the applicable European Directives.	
Name of the safety component:	PROTECT-IE02 PROTECT-IE02-SK PROTECT-IE11 PROTECT-IE11-SK
Description of the safety component:	Safety-monitoring module as input expander in conjunction with a safety-monitoring module as basic device
Relevant EC-Directives:	2006/42/EC-EC-Machinery Directive 2004/108/EC EMC-Directive
Person authorized for the compilation of the technical documentation:	Oliver Wacker Möddinghofe 30 42279 Wuppertal
Notified body, which approved the full quality assurance system, referred to in Appendix X, 2006/42/EC:	TÜV Rheinland Industrie Service GmbH Alboinstraße 56 12103 Berlin ID n°: 0035
Place and date of issue:	Wuppertal, 06.08.2013
PROTECT-IE-D-EN	 Authorised signature Philip Schmersal Managing Director



The currently valid declaration of conformity can be downloaded from the internet at www.schmersal.net.



K. A. Schmersal GmbH & Co. KG
Industrielle Sicherheitssysteme
Möddinghofe 30, D - 42279 Wuppertal
Postfach 24 02 63, D - 42232 Wuppertal

Phone: +49 - (0)2 02 - 64 74 - 0
Telefax +49 - (0)2 02 - 64 74 - 1 00
E-Mail: info@schmersal.com
Internet: <http://www.schmersal.com>