



EN Operating instructions.pages 1 to 4
Translation of the original operating instructions

Content

1 About this document

1.1 Function 1

1.2 Target group: authorised qualified personnel. 1

1.3 Explanation of the symbols used 1

1.4 Appropriate use 1

1.5 General safety instructions 1

1.6 Warning about misuse 1

1.7 Exclusion of liability 1

2 Product description

2.1 Ordering code 2

2.2 Special versions. 2

2.3 Destination and use 2

2.4 Technical data 2

3 Mounting

3.1 General mounting instructions 2

3.2 Dimensions 2

3.3 Mounting set-up and actuating distances 3

4 Electrical connection

4.1 General information for electrical connection. 3

4.2 Adjustment. 3

5 Set-up and maintenance

5.1 Functional testing. 3

5.2 Maintenance 3

6 Disassembly and disposal

6.1 Disassembly. 3

6.2 Disposal 3

7 Appendix

7.1 EC Declaration of conformity 4

1. About this document

1.1 Function
This operating instructions manual provides all the information required for the mounting, set-up and commissioning to ensure the safe operation and disassembly of the safety switchgear. The operating instructions must be available in a legible condition and a complete version in the vicinity of the device.

1.2 Target group: authorised qualified personnel
All operations described in this operating instructions manual must be carried out by trained specialist personnel, authorised by the plant operator only.

Please make sure that you have read and understood these operating instructions and that you know all applicable legislations regarding occupational safety and accident prevention prior to installation and putting the component into operation.

The machine builder must carefully select the harmonised standards to be complied with as well as other technical specifications for the selection, mounting and integration of the components.

1.3 Explanation of the symbols used

 **Information, hint, note:**
This symbol is used for identifying useful additional information.

 **Caution:** Failure to comply with this warning notice could lead to failures or malfunctions.

Warning: Failure to comply with this warning notice could lead to physical injury and/or damage to the machine.

1.4 Appropriate use
The product must be exclusively used in accordance with the versions listed below or for the applications authorised by the manufacturer. Detailed information regarding the range of applications can be found in the chapter "Product description".

1.5 General safety instructions
The user must observe the safety instructions in this operating instructions manual, the country-specific installation standards as well as all prevailing safety regulations and accident prevention rules.

 Further technical information can be found in the Schmersal catalogues or in the online catalogue on the Internet: www.schmersal.net.

The information contained in this operating instructions manual is provided without liability and is subject to technical modifications.

There are no residual risks, provided that the safety instructions as well as the instructions regarding mounting, commissioning, operation and maintenance are observed.

1.6 Warning about misuse

 In case of inadequate or improper use or manipulations of the component, personal hazards or damage to machinery or plant components cannot be excluded.

1.7 Exclusion of liability
We shall accept no liability for damages and malfunctions resulting from defective mounting or failure to comply with this operating instructions manual. The manufacturer shall accept no liability for damages resulting from the use of unauthorised spare parts or accessories.

For safety reasons, invasive work on the device as well as arbitrary repairs, conversions and modifications to the device are strictly forbidden; the manufacturer shall accept no liability for damages resulting from such invasive work, arbitrary repairs, conversions and/or modifications to the device.

2. Product description

2.1 Ordering code

This operating instructions manual applies to the following types:

BN 325-R①-②

No.	Option	Description
①		without LED
	G	with LED
②		Blade terminal 4.8 mm and 1 shielding plate
	1239	Blade terminal 4.8 mm and 2 shielding plates
	1389	Blade terminal 6.3 mm and 2 shielding plates
	1279	Cable outlet left and 2 shielding plates
	1279-2	Cable outlet right and 2 shielding plates
	LST-1279	Cable with connector, -1279 like above



Only if the information described in this operating instructions manual are realised correctly, the compliance with the Low Voltage Directive is maintained.

2.2 Special versions

For special versions, which are not listed in the order code below 2.1, these specifications apply accordingly, provided that they correspond to the standard version.

2.3 Destination and use

Magnetic switches are preferably used wherever mechanically operated limit switches do not feature a satisfactory operation due to the unfavourable operating conditions. In the elevator industry, magnetic switches are preferably used for positioning and control purposes.

For actuating the magnetic switches, the actuating magnets listed by Schmersal (refer to Automation technology catalogue) can be used. Depending on the chosen combination of magnetic switch and actuating magnet, the switching distances and travels may vary.

2.4 Technical data

Standards:	-
Enclosure and cover:	glass-fibre reinforced thermoplastic
Protection class:	
- Ordering suffix -1239 and -1389:	IP00
- Ordering suffix -1279 and -1297-2:	IP67
Termination:	
- Ordering suffix -1239:	Blade terminal 4.8 mm
- Ordering suffix -1389:	Blade terminal 6.3 mm
- Ordering suffix -1279 and -1279-2:	Cable outlet
- Ordering suffix -LST-1279:	Cable with connector
Operating principle:	magnetic
Switching voltage:	max. 250 VAC
Switching current:	max. 3 A
Switching capacity:	max. 120 VA
Sparkover voltage:	> 600 VAC (50 Hz)
Switching speed:	max. 18 m/s
Switching frequency:	max. 300/s
Switching time "Close":	max. 1.5 ms
Switching time "Open":	max. 0.5 ms
Bounce duration:	0.3 ... 0.6 ms
Ambient temperature:	- 25 °C ... + 75 °C
Mechanical life:	1 billion operations
Electrical life:	1 million - 1 billion operations, depending on load
Resistance to shock:	50 g / 11 ms
Resistance to vibration:	30 g on sine wave oscillation
Resistance to vibration:	10 ... 55 Hz, amplitude 1 mm
Switching point accuracy:	± 0.25 mm, T = constant

3. Mounting

3.1 General mounting instructions



The installation may only be carried out by authorised personnel.

- Any mounting position.
- Do not install the magnetic switch and the actuating magnet in strong magnetic fields
- Keep away from metal chips
- Do not expose the magnetic switch and the actuating magnet to strong vibrations and heavy shocks
- Do not use the magnetic switch and the actuating magnet as end stop
- The mounting distance between two sensors should always be at least 30 mm



When using more than one magnet switch, consider figures next page.

3.2 Dimensions

All measurements in mm.

Blade terminal

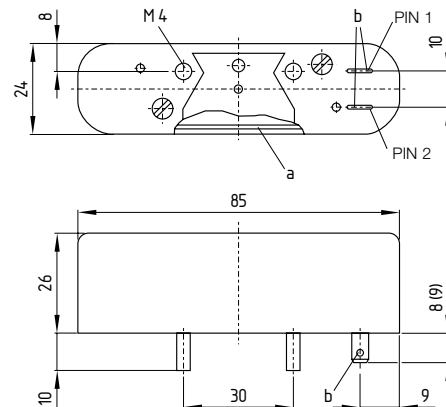

Cable outlet

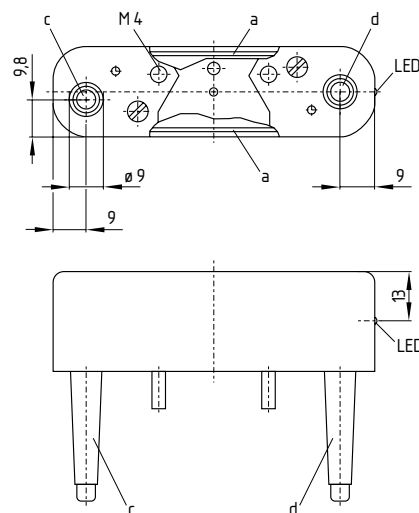

Key

- a Shielding plate
- b Blade terminal
- c Cable outlet left (Index -1279)
- d Cable outlet right (Index -1279-2)

3.3 Mounting set-up and actuating distances

Positioning of the switches when using more than one magnet switch (actuating distance for all BN 325 with 2 shielding plates at $-20\text{ }^{\circ}\text{C} \dots +50\text{ }^{\circ}\text{C}$)

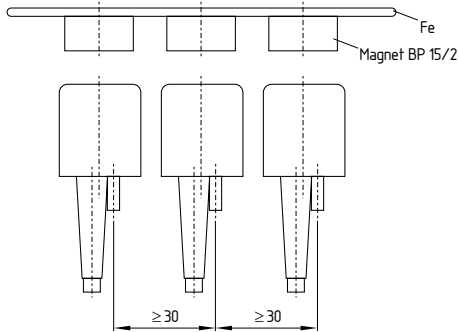

Achievable switching distance, even by offset of the actuating magnet

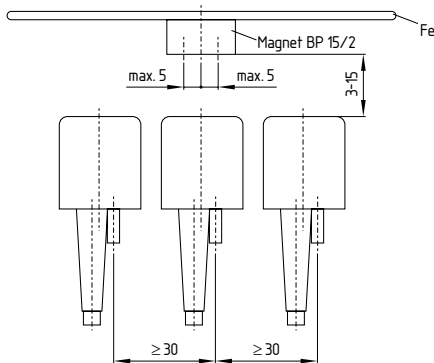

Maximum side-ways offset of two actuating magnets, whereby the middle switch will not be affected.

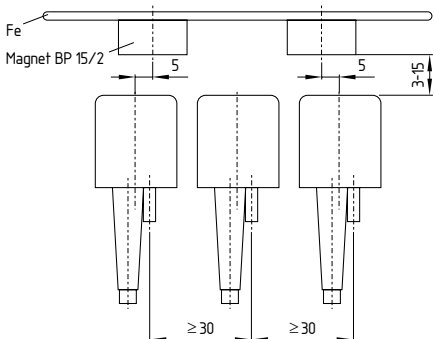

The specified switching distances are applicable for the actuation of individually mounted components without ferromagnetic influence. A change of the distance, positive either negative, is possible due to ferromagnetic influences. The mutual interference between multiple actuating magnets must be observed. (For special versions: diverging values possible)

Magnetic switches with bistable contacts will only function correctly, when a magnetic north (green) or south (red) pole goes past the active surface. The NC or NO function depends on the actuating direction and the polarity of the actuating magnet.



Further information on the switching distances can be found in the Automation technology catalogue in appendix.

4. Electrical connection

4.1 General information for electrical connection



The electrical connection may only be carried out by authorised personnel in a de-energised condition.

BN 325-R
BN 325-R-1239
BN 325-R-1389

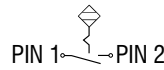

BN 325-R-1279
BN 325-R-1279-2

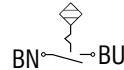

BN 325-RG-1279

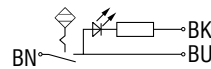

BN 325-R-LST-1279

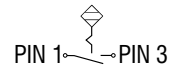

BN 325-RG-LST-1279

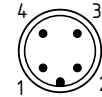
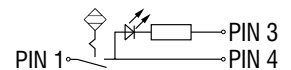

Inductive loads (e.g. contactors, relays, etc.) are to be provided with suitable interference suppression circuitry.

4.2 Adjustment

In order to actuate the BN 325-R/RG magnetic switch, a north or south pole magnet should be used. The markings found on the actuating side of the cover are used for adjusting the magnet to the switch. The coloured symbols including arrows, show the proper magnet arrangements and the actuating direction. The magnets have the corresponding coloured markings.

5. Set-up and maintenance

5.1 Functional testing

The function of the component must be tested. The following conditions must be previously checked and met:

1. Check the correct fixing of the magnetic switch and the actuating magnet
2. Integrity of the magnetic switch and the actuating magnet
3. Check the switch enclosure for damage
4. Check the functionality of the switch

5.2 Maintenance

A regular visual inspection and functional test, including the following steps, is recommended:

1. Check the functionality of the switch
2. Remove particles of dust and soiling

Damaged or defective components must be replaced.

6. Disassembly and disposal

6.1 Disassembly

The switch must be disassembled in a de-energised condition only.

6.2 Disposal

The switch must be disposed of in an appropriate manner in accordance with the national prescriptions and legislations.

7.1 EC Declaration of conformity

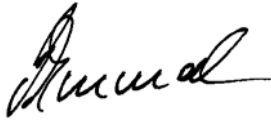
EC Declaration of conformity		
Translation of the original Declaration of Conformity	K. A. Schmersal GmbH & Co. KG Möddinghofe 30, 42279 Wuppertal Germany Internet: www.schmersal.com	
We hereby certify that the hereafter described components both in their basic design and construction conform to the applicable European Directives.		
Name of the component:	BN 1..., BN 2..., BN 3..., BN 6..., BN 7..., BN 8.	
Description of the component:	Magnetic reed switches	
Relevant EC-Directives:	2006/95/EG EC Low Voltage Directive	
Place and date of issue:	Wuppertal, November 22, 2013	
BN 1xx-8x-D-EN		
	Authorised signature Philip Schmersal Managing Director	



The currently valid declaration of conformity can be downloaded from the internet at www.schmersal.net.



K. A. Schmersal GmbH & Co. KG
Möddinghofe 30, D - 42279 Wuppertal
Postfach 24 02 63, D - 42232 Wuppertal

Phone: +49 - (0)2 02 - 64 74 - 0
Telefax: +49 - (0)2 02 - 64 74 - 1 00
E-Mail: info@schmersal.com
Internet: <http://www.schmersal.com>