



EN Operating instructions. pages 1 to 14
Translation of the original operating instructions

FR Vous trouverez la version actuelle du mode d'emploi dans votre langue nationale officielle sur l'Internet, www.schmersal.net.

ES Encontrará el manual de instrucciones actual en su idioma oficial de la UE en nuestra página de Internet www.schmersal.net.

NL U vindt de huidige versie van de gebruikshandleiding in uw officiële landstaal op het Internet, www.schmersal.net.

IT Il manuale d'istruzioni aggiornato nella vostra lingua (lingua ufficiale UE) è scaricabile in Internet all'indirizzo www.schmersal.net.

JP EU公用語で書かれた最新の取扱説明書は、インターネット (www.schmersal.net) からダウンロードできます。

Content

1	About this document	
1.1	Function.	1
1.2	Target group: authorised qualified personnel	1
1.3	Explanation of the symbols used.	1
1.4	Appropriate use.	1
1.5	General safety instructions	2
1.6	Warning about misuse.	2
1.7	Exclusion of liability.	2
2	Product description	
2.1	Ordering code	2
2.2	Special versions	2
2.3	Scope of delivery and accessories	2
2.4	Destination and use.	2
2.5	Technical data	3
2.6	Response time (reaction time)	3
2.7	Safety classification.	3
2.8	Functions.	4
2.8.1	Protective mode	4
2.8.2	Restart interlock (manual reset)	4
2.8.3	Fixed blanking	4
2.8.4	Contact control EDM (feedback)	4
2.8.5	Start interlock	5
2.8.6	Testing.	5
3	Mounting	
3.1	General conditions	5
3.2	Protection field and approach	5
3.3	Alignment	6
3.4	Safety distance	6
3.4.1	Minimum distance to reflecting surfaces	7
3.5	Dimensions	8
4	Electrical connection	
4.1	Wiring example default	10
4.2	Connector configuration Receiver & Emitter (+ possibly accessories cable)	10

5	Set-up and maintenance	
5.1	Check before start-up	11
5.2	Maintenance	11
5.3	Regular check	11
5.4	Half-yearly inspection	11
5.5	Cleaning	11
6	Diagnostic	
6.1	LED status information	12
6.2	Fault diagnostic.	12
6.3	Extended diagnostic	13
7	Disassembly and disposal	
7.1	Disassembly	13
7.2	Disposal.	13
8	Appendix	
8.1	Contact	13
8.2	EC Declaration of conformity.	14

1. About this document

1.1 Function

This operating instructions manual provides all the information you need for the mounting, set-up and commissioning to ensure the safe operation and disassembly of the safety switchgear. The operating instructions must be available in a legible condition and a complete version in the vicinity of the device.

1.2 Target group: authorised qualified personnel

All operations described in this operating instructions manual must be carried out by trained specialist personnel, authorised by the plant operator only.

Please make sure that you have read and understood these operating instructions and that you know all applicable legislations regarding occupational safety and accident prevention prior to installation and putting the component into operation.

The machine builder must carefully select the harmonised standards to be complied with as well as other technical specifications for the selection, mounting and integration of the components.

1.3 Explanation of the symbols used



Information, hint, note:

This symbol is used for identifying useful additional information.



Caution: Failure to comply with this warning notice could lead to failures or malfunctions.

Warning: Failure to comply with this warning notice could lead to physical injury and/or damage to the machine.

1.4 Appropriate use

The products described in these operating instructions are developed to execute safety-related functions as part of an entire plant or machine. It is the responsibility of the manufacturer of a machine or plant to ensure the correct functionality of the entire machinery or plant.

The safety switchgear must be exclusively used in accordance with the versions listed below or for the applications authorised by the manufacturer. Detailed information regarding the range of applications can be found in the chapter "Product description".

1.5 General safety instructions

The user must observe the safety instructions in this operating instructions manual, the country-specific installation standards as well as all prevailing safety regulations and accident prevention rules.



Further technical information can be found in the Schmersal catalogues or in the online catalogue on the Internet: www.schmersal.net.

The information contained in this operating instructions manual is provided without liability and is subject to technical modifications.



The entire concept of the control system, in which the safety component is integrated, must be validated to EN ISO 13849-2.

There are no residual risks, provided that the safety instructions as well as the instructions regarding mounting, commissioning, operation and maintenance are observed.

Additional measures could be required to ensure that the system does not present a dangerous breakdown, when other forms of light beams are available in a special application (e.g. use of wireless control devices on cranes, radiation of welding sparks or effects of stroboscopic lights).

1.6 Warning about misuse



In case of inadequate or improper use or manipulations of the safety switchgear, personal hazards or damage to machinery or plant components cannot be excluded. The relevant requirements of the standards EN ISO 13855 (successor of EN 999) and EN ISO 13857 must be observed.

1.7 Exclusion of liability

We shall accept no liability for damages and malfunctions resulting from defective mounting or failure to comply with this operating instructions manual. The manufacturer shall accept no liability for damages resulting from the use of unauthorised spare parts or accessories.

For safety reasons, invasive work on the device as well as arbitrary repairs, conversions and modifications to the device are strictly forbidden; the manufacturer shall accept no liability for damages resulting from such invasive work, arbitrary repairs, conversions and/or modifications to the device.

2. Product description

2.1 Ordering code

This operating instructions manual applies to the following types:

SLC 220-E/R^①-^②-69-RFB-^③

No.	Option	Description
①	xxxx	Protection field heights in mm available lengths: 0175*, 0250*, 0325, 0475, 0625, 0775, 0925, 1075, 1225, 1375, 1525, 1675
②	30, 80	Resolution 30, 80 mm
③	H	Range 0.3 m ... 6 m Range 4 m ... 14 m (high range)

* only for resolution 30 mm

SLG 220-E/R^①-69-RF^②

No.	Option	Description
①	0500-02 0800-03 0900-04	Distance between outermost beams: 500 mm, 2-beam 800 mm, 3-beam 900 mm, 4-beam
②	H	Range 0.3 m ... 6 m Range 5 m ... 30 m (high range)



Only if the information described in this operating instructions manual are realised correctly, the safety function and therefore the compliance with the Machinery Directive is maintained.

2.2 Special versions

For special versions, which are not listed in the order code below 2.1, these specifications apply accordingly, provided that they correspond to the standard version.

2.3 Scope of delivery and accessories

Accessories included in delivery

Connecting cable for emitter and receiver

Cable length 5,0 m, Cable connector M12 x 1; 8-pole integrated transmitter and receiver

Mounting kit MS-1035

The kit includes 4 mounting angles, material V4A and 16 fixing screws, material V4A for fixation to the end caps.

Test rod PLS-01

The test rod is used for testing the protection field. The PLS-01 test rod has a diameter of 30 mm.

Optional accessories

Safety relays

For processing the signal outputs OSSD 1 and OSSD 2 of the SLC/SLG 220 series, the use of a safety relay is recommended. This safety relay must meet the safety requirements for the chosen safety level. More technical information regarding safety switching appliances can be found on our homepage www.schmersal.com.

Connecting cable

Item number	Designation	Description	Length
1207728	KA-0904	Female connector M12, 8-pole	5 m
1207729	KA-0905	Female connector M12, 8-pole	10 m
1207730	KA-0908	Female connector M12, 8-pole	20 m

The connecting cables can be used for transmitter and receiver.

BUS converter NSR-0700

Converter for parametrization and diagnostics. Detailed information can be found in the operating instructions manual of the NSR-0700. Included in delivery: integrated connecting cable, PC-software WIN 95, 98, NT, XP; RS 232 connection. (L x W x H, 122 x 60 x 35 mm)

MSD2 Vibration damper

Kit comprising: 8 vibration dampers 15 x 20 mm, 8x M5 socket head cap screws, 8 spring washers. The MSD2 vibration damper kit must be used for damping vibrations and oscillations on the SLC/SLG 220. For applications with higher mechanical stresses, we recommend the MSD2 kit. In this way, the availability of the SLC/SLG 220 is increased.

2.4 Destination and use

The SLC/SLG is a non-contact, self-testing safety guard, which is used for the protection of hazardous points, hazardous areas and machine accesses. If one or more light beams are interrupted, the hazardous movement must be stopped.



If liquids with aggressive ingredients are used for cleaning, please check whether the product used is compatible with the material of the sensor (refer to chapter "Technical data").



The user must evaluate and design the safety chain in accordance with the relevant standards and the required safety level.

2.5 Technical data

Standards:	EN 61496-1; CLC/TS 61496-2; EN ISO 13849; EN 62061
Material of the enclosure:	Aluminium
Protective tube:	PMMA Plastic tubes
End plugs:	PA 6
Membran:	PA 6, Gore Tex Membran M12 x 1.5
Number of beams:	
SLC 220:	6 ... 66 (Standard),
SLG 220:	2, 3, 4 beams
Protection field heights :	
SLC 220:	175 mm ... 1675 mm Standard,
SLG 220:	500 mm, 800 mm, 900 mm
Beam distance:	SLG 220: 300 mm, 400 mm, 500 mm
Reaction time:	
SLC 220:	9 ... 65 ms,
SLG 220:	12 ... 19 ms
Detection sensitivity for test bodies:	30 mm, 80mm
Range of the protection field:	
SLC 220:	0,3 ... 6 m (standard), 4 ... 14 m (high range)
SLG 220:	0,3 ... 6 m (standard) 5 ... 30 m (high range)
Rated operating voltage:	24 VDC ±10% (PELV) supply unit to EN 60204 (power drop > 20 ms)
Operating current:	400 mA max. + 0.5 A (OSSD load + output signal quality load)
Wave length of the sensor:	880 nm
"Safety outputs (OSSD1, OSSD2)":	2 x PNP-type semi-conductor, short-circuit proof
Switching voltage HIGH ¹ :	15 ... 28,8 V
Switching voltage LOW ¹ :	0 ... 2 V
Switching current:	0 ... 200 mA
Leakage current ² :	1 mA
Load capacity:	2 µF
Load inductance:	2 H
Admissible conduction resistance between OSSD and load:	2.5 Ω
Supply cable:	1 Ω
Contactor control (EDM):	
Input voltage HIGH (inactive):	17 ... 29 V
Input voltage LOW (active):	0 ... 2.5 V
Input current HIGH:	3 ... 10 mA
Input current LOW:	0 ... 2 mA
Input restart interlock (manual reset)	
Input voltage HIGH (active):	17 ... 29 V
Input voltage LOW (inactive):	0 ... 2.5 V
Input current HIGH:	11 ... 120 mA
Input current LOW:	0 ... 2 mA
Function:	
SLC 220:	Protective mode, start and restart interlock, contactor control, fixed beam blanking,
SLG 220:	start and restart interlock, contactor control
Signal times	
Contactor control:	20 ... 300 ms
Restart interlock (manual reset):	20 ms ... 1.0 s signal trans- mission in case of trailing edge
Start interlock:	250 ... 1500 ms, adjustable
LED indications transmitter:	Transmitting, status, restart
LED indications receiver:	OSSD ON, OSSD OFF, signal recepti- on, blanking

Connection:	screwed cable gland M16 x 1,5 Cable length 5,0 m Cable connector M12 x 1; 8-pole transmitter and receiver integrated
Ambient temperature:	-10° C ... +50° C
Storage temperature:	-25° C ... +70° C
Interface:	Diagnostics and function setting
Protection class:	IP69K
Resistance to vibrations:	10 ... 55 Hz to IEC 60068-2-6
Resistance to shock:	10 g; 16 ms; to IEC 60068-2-29
Year of construction:	as of 2010 version 1.0

¹) To IEC 61131-2

²) In case of failure, the leakage current at the most flows to the OSSD cable. The downstream control element must recognise this state as LOW. A safety PLC must detect this state.

2.6 Response time (reaction time)

The response time depends on the height of the protected field, the resolution and the number of light beams.

Resolution 30 mm			
Protected height [mm]	Beams [Number]	Response time [ms]	Weight [kg]
175	6	12	1.0
250	9	12	1.3
325	12	12	1.4
475	18	16	2.0
625	24	19	2.6
775	30	23	3.2
925	36	27	3.8
1075	42	30	4.4
1225	48	34	5.0
1375	54	37	5.6
1525	60	41	6.2
1675	66	45	6.8

Resolution 80 mm			
Protected height [mm]	Beams [Number]	Response time [ms]	Weight [kg]
325	4	9	1.4
475	6	10	2.0
625	8	12	2.6
775	10	13	3.2
925	12	15	3.8
1075	14	16	4.4
1225	16	18	5.0
1375	18	19	5.6
1525	20	20	6.2
1675	22	21	6.8

SLG 220 multi-beam version			
Beam distance [mm]	Beams [Number]	Response time [ms]	Weight [kg]
500	2	12	2.3
400	3	16	3.6
300	4	19	3.8

2.7 Safety classification

Standards:	EN ISO 13849-1, EN 62061
PL:	up to d
Control category:	up to 2
PFH value:	3.59 x 10 ⁻⁸ / h
SIL:	up to 2
Service life:	20 years

2.8 Functions

The system consists of a receiver and a transmitter. For the described functions, no further switching elements are required. For the diagnostics and function selection, a user-friendly PC-software is offered as accessory. For the connection to a PC, the NSR-0700 BUS converter is required (not included in delivery).

The system has the following features:

- Protective mode (automatic start after release of the protected field)
- Start interlock
- Restart interlock (manual reset)
- Contactor control EDM
- Blanking of fixed protection field areas

Factory setting

The SLC/SLG 220 system features many functions without additional devices. The following table gives an overview of the possible functions and the factory settings configuration.

Function	Factory setting	Configuration
Protective mode	not active	External wiring
Restart interlock (manual reset)	active	External wiring
Fixed blanking	not active	With BUS converter NSR-0700 and PC-software
Contactor control	not active	With BUS converter NSR-0700 and PC-software
Start interlock	not active	With BUS converter NSR-0700 and PC-software
Switch-on delay	not active	With BUS converter NSR-0700 and PC-software

2.8.1 Protective mode

The protective mode switches the OSSD outputs to ON state (protection field not interrupted), without external release of a switching device. This type of protection generates an automatic restart of the machine if the protection field is not interrupted.



This operating mode may only be chosen in conjunction with the restart interlock of the machine. This operating mode must not be chosen, when persons can step behind the protection field.

2.8.2 Restart interlock (manual reset)

The restart interlock prevents an automatic enabling of the outputs (OSSD's ON state) after switch-on of the operating voltage or an interruption of the protection field.

Restart interlock (manual reset) active (factory setting)

The SLC/SLB 220 series only switches to the ON state, when a command device is connected to the restart interlock input. To enable the outputs, the command device must be actuated no longer than 2.5 seconds.

Deactivating the restart interlock (manual reset)

Wire the restart interlock input (PIN 1) of the transmitter to the signal quality output (PIN 1) of the receiver.



The command devices (enabling button) must be installed outside of the hazardous area. The operator must have a clear view on the hazardous area when actuating the enabling button.

2.8.3 Fixed blanking

The SLC 220 can blank stationary parts in the protection field.

Multiple protection field areas can be blanked.

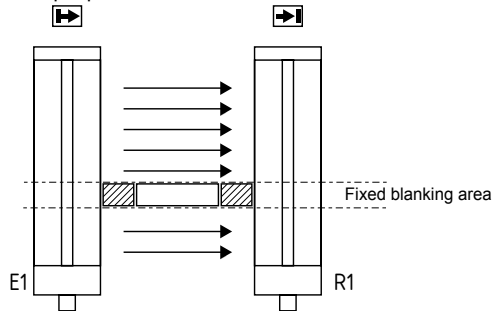

The range of the fixed blanking can be arbitrarily chosen in the protection field. Multiple areas can be blanked. At least one light beam must be active in the protection field.



The area of the fixed blanking must not be modified after the teach-in process. Any change of the area or removal of the part from the protection field will result in the absence of monitoring in certain areas of the protection field. After every shifting (part(s) in the protection field), a new teach-in process must be executed.



- The remaining lateral areas must be protected against intrusion by means of mechanical covers.
- The lateral covers must be fixed with the object. Partial covers are not authorised.
- After the fixed blanking, the protection field must be tested by means of the test rod.
- The restart interlock function of the safety light curtain or the machine must be activated.
- The standard IEC/TS 62046 includes information, which describes possibly required additional measures to prevent a person from reaching a hazard through the blanking areas of a protection field.
- After configuration, the protection field must be checked by a responsible person by means of a test rod; in addition to that, this person must compare the size of the blanked area to the object size and if necessary provide for additional covers or a larger distance of the safety guard with regard to the hazardous point.



The function is activated by means of the NSR-0700 BUS converter and a PC or laptop. The activation of the function is signaled by the LED blanking flashing in the diagnostic window of the transmitter.

The light beams of the SLG 220 series cannot be blanked.

2.8.4 Contactor control EDM (feedback)

The contactor control monitors the controlled switching elements (auxiliary contacts of the contactors) of both outputs. This monitoring is realised after each interruption of the protection field and prior to the restart (enabling) of the outputs. In this way, malfunctions of the relays are detected, e.g. contact welding or contact spring breakage. If the light curtain detects a malfunction of the switching elements, the outputs are locked. After fault rectification, the operating voltage must be once switched off and back on (power reset).



The contactor control is not activated upon delivery. This function is activated by means of the NSR-0700 BUS converter and a PC or laptop.

2.8.5 Start interlock

The start interlock prevents an automatic start of the machine when the supply voltage is switched on. After enabling of the start interlock - by the one-time interruption of the protection field -, this protective function is deactivated until the next power reset.



The start interlock is not activated upon delivery. This function is activated by means of the NSR-0700 BUS converter and a PC or laptop.

2.8.6 Testing

The system performs a complete self-test within 2 seconds after the operating voltage has been switched on. After this self-test, the system switches to the ON state, if the protection field is clear.



The system will check all safety-technical functions in the background within a cycle time of 2 seconds. Within this time, a check of all functional components as well as a complete memory test will take place. The main advantage for the user is the omission of the system test (test before each machine cycle).

In this operating mode, both outputs (OSSD1 and OSSD2) must be integrated in the application, separated from each other (second switch-off path - refer to wiring diagram 4.1).

External test

The system can trigger a test cycle by means of the external test input. By applying a signal (+ 24 VDC) at the test output, a complete self-test is executed within 150 ms. After 15 ms, the outputs change to OFF state and are re-enabled after 150 ms if no fault is detected. The test cycle must be triggered by the machine control. The signal change at the outputs of the SLC/SLG 220 series must be monitored. In case of a fault, the outputs will not be re-enabled until the fault is rectified.



If the test cycle of the application/machine cannot be completed within 150 ms, the restart interlock of the SLC/SLG 220 series must be activated (refer to wiring diagram 4.1). The max. test time of 150 ms must be observed to the standard EN 61496.

3. Mounting

3.1 General conditions

The following guidelines are provided as preventive warning notices to ensure a safe and appropriate handling. These guidelines are an essential part of the safety instructions and therefore must always be observed and respected.



- The SLC/SLG must not be used on machines, which can be stopped electrically in case of emergency.
- The safety distance between the SLC/SLG and a hazardous machine movement must always be observed and respected.
- Additional mechanical safety guards must be installed so that the operator has to pass by the protection field to reach the hazardous machine parts.
- The SLC/SLG must be installed so that the personnel always must be within the detection zone when operating the machine. An incorrect installation can lead to serious injuries.
- Never connect the outputs to +24VDC. If the outputs are wired to +24VDC, they are in ON state, as a result of which they are unable to stop a hazardous situation occurring on the application/machine.
- The safety inspections must be conducted regularly.
- The SLC/SLG must not be exposed to inflammable or explosive gasses.
- The connecting cables must be connected in accordance with the installation instructions.
- The fixing screws of the end caps and the mounting angle must be firmly tightened.
- When fitting the sensors, please observe that the cable output is at the bottom in order not to affect the functionality of the membrane.

3.2 Protection field and approach

The protection field of the SLC/SLG consists of the entire range located between the protection field markings of transmitter and receiver. Additional protective devices must ensure that the operator has to pass by the protection field to reach the hazardous machine parts.

The SLC/SLG must be installed so that the personnel is always located within the detection zone of the safety device when operating the hazardous machine parts to be secured.

Correct installation

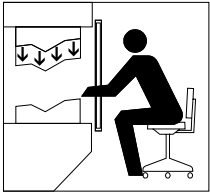

Hazardous machine parts can only be reached after passing through the protection field.

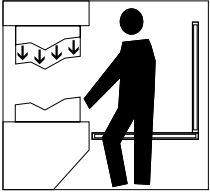

The presence of staff members between the protection field and hazardous machine parts must be prevented/avoided (protection against stepping over).

Unauthorised installation

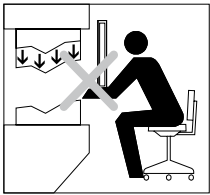

Hazardous machine parts can be reached without passing through the protection field.

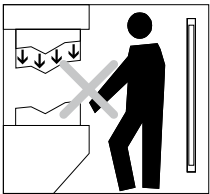

The presence of staff members between the protection field and hazardous machine parts is enabled.

3.3 Alignment

Procedure:

1. The transmitter and the receiver must be fitted parallel to each other and at the same height.
2. Turn the transmitter and monitor the diagnostic window of the receiver. Fix the light curtain, when the LED OSSD ON (green) is on and the LED signal reception (orange) is off.
3. Determine the max. rotating angle to the left and to the right, at which the LED OSSD ON (green) is on and tighten the mounting screws in central position. Make sure that the LED signal reception (orange) is not on or flashing.

3.4 Safety distance

The safety distance is the minimum distance between the protection field of the safety light curtain and the hazardous area. The safety distance must be observed to ensure that the hazardous area cannot be reached before the hazardous movement has come to standstill.

Calculation of the safety distance

The safety distance to EN ISO 13855 (successor of EN 999) and EN ISO 13857 depends on the following elements:

- Stopping time of the machine (calculation by stopping time measurement)
- Response time of the machine and the safety light curtain and the downstream relay (entire safety guard)
- Approach speed
- Resolution of the safety light curtain

Safety light curtain SLC 220

The safety distance for resolutions 14 mm up to 40 mm is calculated by means of the following formula:

$$S = 2000 \text{ mm/s} * T + 8 (d - 14) \text{ [mm]}$$

S = Safety distance [mm]

T = Total reaction time (machine stopping time, reaction time of the safety guard, relays, etc.)

d = Resolution of the safety light curtain

The approach speed is covered with a value of 2000 mm/s

If value $S \leq 500$ mm after the calculation of the safety distance, then use this value.

If value $S \geq 500$ mm, recalculate the distance:

$$S = 1600 \text{ mm/s} * T + 8 (d - 14) \text{ [mm]}$$

If the new value $S > 500$ mm, use this value as safety distance.

If the new value $S < 500$ mm, use a minimum distance of 500 mm.

Example:

Reaction time of the safety light curtain = 20 ms

Resolution of the safety light curtain = 30 mm

Stopping time of the machine = 210 ms

$$S = 2000 \text{ mm/s} * (210 \text{ ms} + 20 \text{ ms}) + 8(30 \text{ mm} - 14 \text{ mm})$$

$$S = 588 \text{ mm}$$

$$S > 500 \text{ mm, therefore new calculation with } V = 1600 \text{ mm/s}$$

$$S = 496 \text{ mm}$$

$$\text{New value} = 496 \text{ mm} < 500 \text{ mm}$$

$$S = 500 \text{ mm}$$

The safety distance for resolution 80 mm is calculated by means of the following formula:

$$S = (1600 \text{ mm/s} * T) + 850 \text{ mm}$$

S = Safety distance [mm]

T = Stopping time of the machine + reaction time of the safety light curtain

K = Approach speed 1600 mm/s

C = Safety supplement 850 mm



The safety distance between the safety light curtain and the hazardous point must always be respected and observed.

If a person reaches the hazardous point before the hazardous movement has come to standstill, he/she is exposed to serious injuries.

Safety distance to the hazardous area

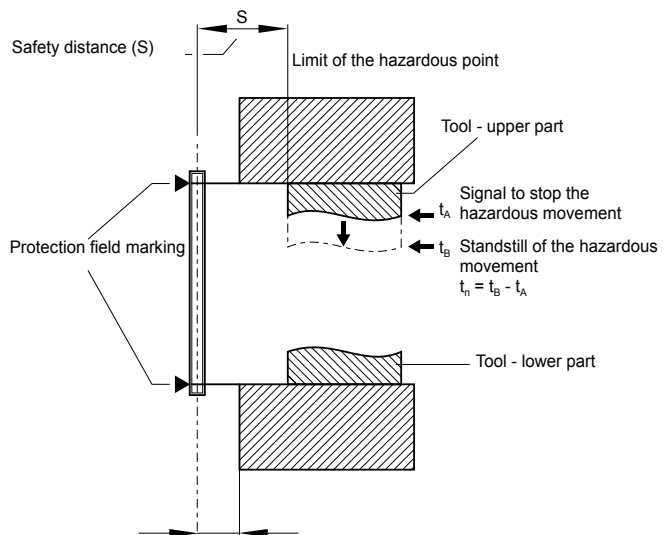

≤ 75 mm = max. distance for protection against stepping over
To prevent persons from stepping over the protection field this dimension must be imperatively respected and observed.

Safety distance for multi-beam version SLG 220 (beam distance 300, 400 and 500 mm)

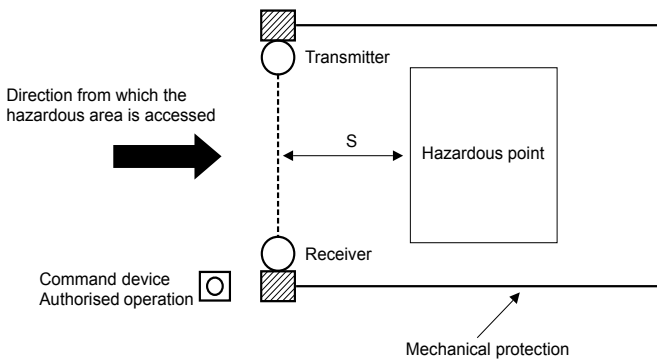

The formulae and calculation examples are related to the vertical set-up (refer to drawing) of the safety light grid with regard to the hazardous point. Please observe the applicable harmonised EN standards and possible applicable national regulations.

The protection using individual beams must be chosen so that bodies or body parts larger than the selected resolution (beam distance + beam diameter 10 mm) of the SLG 220 are detected.

The safety distance is the minimum distance between the SLG 220 and the hazardous point, which must be observed in order to ensure that the hazardous point can only be reached after the hazardous movement has come to standstill.

Calculation of the safety distance for the multi-beam light grid:

$$S = (1600 \text{ mm/s} \cdot T) + 850 \text{ mm}$$

- S = Safety distance [mm]
- T = Stopping time of the machine + reaction time of the safety light grid
- K = Approach speed 1600 mm/s
- C = Safety supplement 850 mm

Example:

Reaction time of the SLG 220 = 12 ms
 Stopping time of the machine T = 170 ms
 $S = 1600 \text{ mm/s} \cdot (170 \text{ ms} + 12 \text{ ms}) + 850 \text{ mm}$
 S = 1141 mm

The following mounting heights must be observed:

Number of beams	Mounting height above reference floor in mm
2	400, 900
3	300, 700, 1100
4	300, 600, 900, 1200



The successor standards of the EN 999 for calculating the minimum distances of the safety guards with regard to the hazardous point are EN ISO 13855 and EN ISO 13857.



The safety distance between the safety light grid and the hazardous point must always be respected and observed. If a person reaches the hazardous point before the hazardous movement has come to standstill, he/she is exposed to serious injuries.

3.4.1 Minimum distance to reflecting surfaces

During the installation, the effects of reflecting surfaces must be taken into account. In case of an incorrect installation, interruptions of the protection field could possibly not be detected, which could lead to serious injuries. The hereafter-specified minimum distances with regard to reflecting surfaces (metal walls, floors, ceilings or parts) must be imperatively observed.

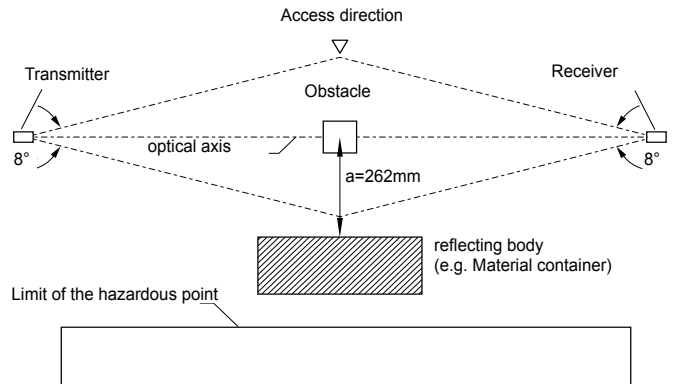
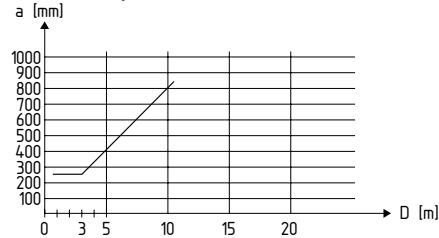

Table: Safety distance a



The effective aperture angle for the SLC/SLG 220 series is $\pm 4.0^\circ$ for a mounting distance of $> 3.0 \text{ m}$. Calculate the minimum distance to reflecting surfaces as a function of the distance with an aperture angles of $\pm 5.0^\circ$ degrees or use the value from the table below:



The correct combination (type, resolution) of transmitter and receiver always must be taken into consideration. If this is not observed, this could result in incorrect operation of the devices due to mutual interference.

Distance [m] between transmitter and receiver	Minimum distance a [mm]
0.2 ... 3.0	262
4	350
5	437
6	525

Formula: $a = \tan 5^\circ \times L$ [mm]

- a = Minimum distance to reflecting surfaces
- L = Distance between transmitter and receiver

3.5 Dimensions

All measurements in mm.

SLC 220 IP69K default transmitter and receiver

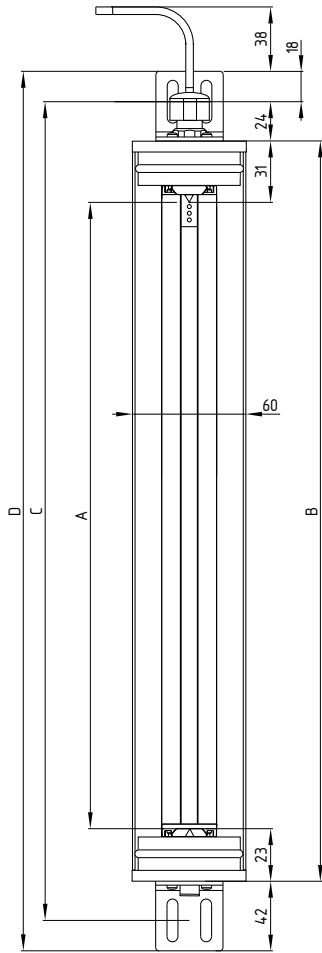

Legend

- A Protection field height
- B Sensor length
- C Mounting dimension
- D Total length

Type	A	B	C	D
SLC 220-E/R0175-xx-69-RFB	175	241.5	289.5	325.5
SLC 220-E/R0250-xx-69-RFB	250	304	352	388
SLC 220-E/R0325-xx-69-RFB	325	379	427	463
SLC 220-E/R0475-xx-69-RFB	475	529	577	613
SLC 220-E/R0625-xx-69-RFB	625	679	727	763
SLC 220-E/R0775-xx-69-RFB	775	829	877	913
SLC 220-E/R0925-xx-69-RFB	925	979	1027	1063
SLC 220-E/R1075-xx-69-RFB	1075	1129	1177	1213
SLC 220-E/R1225-xx-69-RFB	1225	1279	1327	1363
SLC 220-E/R1375-xx-69-RFB	1375	1429	1477	1513
SLC 220-E/R1525-xx-69-RFB	1525	1579	1627	1663
SLC 220-E/R1675-xx-69-RFB	1675	1729	1777	1813

All versions with resolution 30 and 80 mm as well as variant (-H) range from 4.0 to 14.0 m have identical dimensions with the same protection field height.

For the SLC 220-E/R0175-30-69-RFB type, the dimension changes from 23 mm to 35,5 mm due to the extended profile length. The protection field is marked with an individual marking.

SLG 220 multi-beam transmitter and receiver

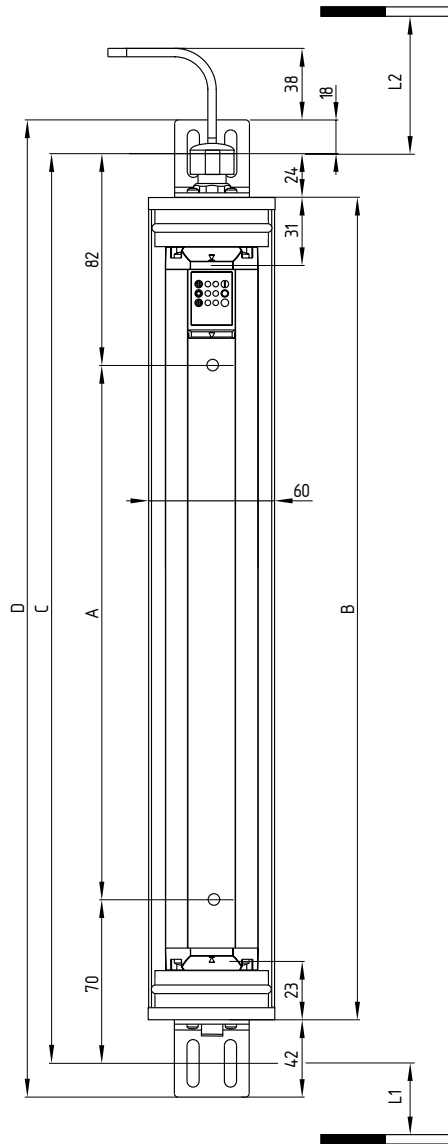

Legend

- A Beam distance
- B Sensor length
- C Mounting dimension
- D Total length

Type	A	L1	L2	B	C	D
SLG 220-E/R0500-02-69-RF	500	330	318	604	652	688
SLG 220-E/R0800-03-69-RF	400	230	218	904	952	988
SLG 220-E/R0900-04-69-RF	300	230	218	1004	1052	1088

L1 = Mounting distance (mm) between fixing surface and centre slotted hole (short end cap)

L2 = Mounting distance (mm) between fixing surface and centre slotted hole (diagnostic window)

Accessories

Fixing kit MS-1035

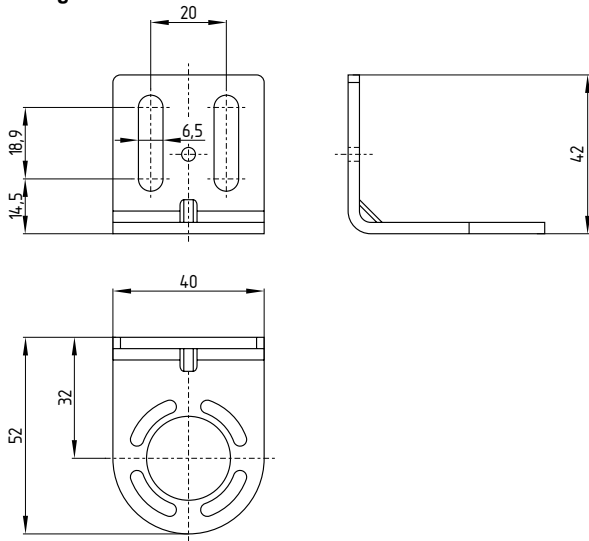

4. Electrical connection

4.1 Wiring example default

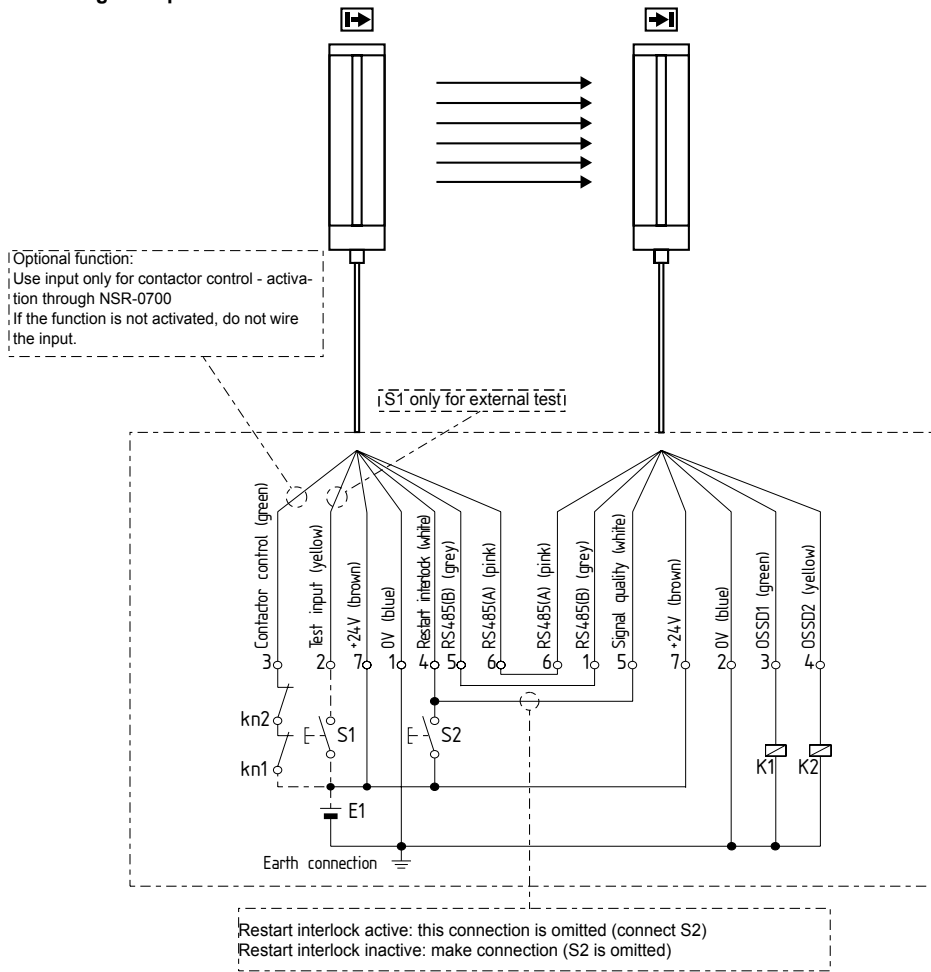

Legend

- K1, K2: Relay for processing the switching outputs OSSD 1, OSSD 2
- kn1, kn2: Auxiliary contacts of the last switching relay for contactor control (optional)
- S1: Command device for external test (optional)
- S2: Command device for restart interlock (manual reset) enabling
- E1: Power supply 24 VDC ± 10%
- RS 485 (A)/(B): These connections between the transmitter and the receiver are required for the operation

4.2 Connector configuration Receiver & Emitter (+ possibly accessories cable)

Cable: connector male M12 / 8 pole

	Receiver	Transmitter
1 WH	Signal quality	Restart interlock (manual reset)
2 BN	+24 VDC	+24 VDC
3 GN	OSSD 1	Contactor control
4 YE	OSSD 2	Test input
5 GY	RS485 (B)	RS485 (B)
6 PK	RS485 (A)	RS485 (A)
7 BU	0 VDC	0 VDC
8 RD	not used / reserved	not used / reserved

Accessory Cable: Connector female M12 / 8 pole

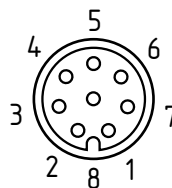

The cables (transmitter and receiver) are permanently fixed to the sensors by means of an M16 x 1.5 cable gland.



The colour codes are only valid for the cable types mentioned below "optional accessories".

5. Set-up and maintenance

5.1 Check before start-up

Prior to start-up, the following items must be checked by the responsible person.

Wiring check prior to start-up

1. The voltage supply is a 24V direct current power supply, which meets the CE Directives, Low Voltage Directives. A power downtime of 20 ms must be bridged.
2. Presence of a voltage supply with correct polarity at the SLC/SLG.
3. The connecting cable of the transmitter is correctly connected to the transmitter and the connecting cable of the receiver correctly to the receiver.
4. The double insulation between the light curtain output and an external potential is guaranteed.
5. The outputs OSSD1 and OSSD2 are not connected to +24 VDC.
6. The connected switching elements (load) are not connected to 24 VDC.
7. If two or more SLC/SLG are used within close range compared to each other, an alternating arrangement must be observed. Any mutual interference of the systems must be prevented.

Switch the SLC/SLG on and check the operation in the following way

The component performs a system test during approx. 2 seconds after the operating voltage has been switched on. After that, the outputs are enabled (if the protection field is not interrupted). The LED "OSSD ON" of the receiver is on.



In case of incorrect functioning, please follow the instructions listed in the chapter Fault diagnostic.

5.2 Maintenance



Do not use the SLC/SLG before the next inspection is terminated. An incorrect inspection can lead to serious and mortal injuries.

Conditions

For safety reasons, all inspection results must be archived. The operating principle of the SLC/SLG and the machine must be known in order to be able conducting an inspection. If the fitter, the planning technician and the operator are different persons, please make sure that the user has the necessary information at his disposal to be able conducting the maintenance.

5.3 Regular check

A regular visual inspection and functional test, including the following steps, is recommended:

1. The component does not have any visible damages.
2. The optics cover is not scratched or soiled.
3. Hazardous machinery parts can only be accessed by passing through the protection field of the SLC/SLG.
4. The staff remains within the detection area, when works are conducted on hazardous machinery parts.
5. The safety distance of the application exceed the mathematically calculated one.

Operate the machine and check whether the hazardous movement stops under the hereafter-mentioned circumstances.

6. Hazardous machine parts do not move when the protection field is interrupted.
7. The hazardous machine movement is immediately stopped, when the protection field is interrupted with the test rod immediately before the transmitter, immediately before the receiver and in the middle between the transmitter and the receiver.
8. No hazardous machine movement when the test rod is within the protection field.
9. The hazardous machine movement comes to standstill, when the voltage supply of the SLC/SLG is switched off.

5.4 Half-yearly inspection

The following items must be checked every six months or when a machine setting is changed.

1. Machine stops or does not inhibit any safety function.
2. No machine modification or connection change, which affects the safety system, has taken place.
3. The outputs of the SLC/SLG are correctly connected to the machine.
4. The total response time of the machine does not exceed the response time calculated during the first putting into operation.
5. The cables, the connectors, the caps and the mounting angles are in perfect condition.

5.5 Cleaning

If the optics cover of the sensors is extremely soiled, the OSSD outputs can be disabled. Clean with a soft cloth without exercising pressure. The use of aggressive, abrasive or scratching cleaning agents, which could attack the surface, is prohibited.

6. Diagnostic

6.1 LED status information

Transmitter

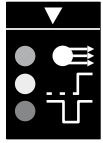

IR power
Restart interlock (manual reset)
External test / blanking

Receiver

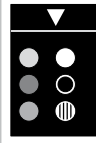

ON
OFF
Signal quality

Function	LED colour	Description	Function	LED colour	Description
IR power	orange	IR transmitter active, signaled by continuous signal	ON	green	OSSD's ON state system check OK, activated protection field clear, signaled by continuous signal
Restart interlock (manual reset)	yellow	Request signal at input restart interlock, signaled by continuous signal	OFF	red	OSSD's OFF state, active protection field interrupted - continuous signal; connection with NSR-0700 or diagnostic flag - flashing
External test / blanking	green	Blanking active, signaled by flashing, test signal active, signaled by continuous signal	Signal quality	orange	Insufficient signal reception, signaling depending on the signal quality

6.2 Fault diagnostic

The light grid performs an internal self-test after the operating voltage is switched on and the protection field is enabled. When a fault is detected, a corresponding flashing pattern is emitted at the receiver through the LED OSSD OFF (red). Every fault emission is followed by a one-second pause.

LED OSSD OFF	Fault feature	Action
OSSD OFF and LED restart continuous flashing	If the function contactor control is activated and no state change has been detected at the contactor control input after enabling of the OSSD.	<ul style="list-style-type: none"> - Check contactor control connection - Check the connected contactor for closed contact (if OSSD ON - contactor control input must show GND level, if OSSD OFF - contactor control input must show +24V) - Switch-on only after POWER OFF/ON
1 flashes	Receiver configuration error or communication error	<ul style="list-style-type: none"> - Check transmitter and receiver configuration - reparameterize (factory setting) with additional software - Replace receiver
2 flashes	Transmitter configuration error or communication error	<ul style="list-style-type: none"> - Check transmitter and receiver configuration - Check transmitter/receiver protection field - Check transmitter/receiver connection - Replace transmitter
3 flashes	Error during the OSSD test Voltage is detected during the OSSD test, although the OSSD are in OFF state.	<ul style="list-style-type: none"> - Check the connecting cables of the OSSD outputs for short-circuits at + Ub (cables, connected devices) - Replace receiver
4 flashes	The cascaded receiver unit is not correctly connected or is defective.	<ul style="list-style-type: none"> - Check connection and configuration of the cascaded receiver (protection field height and resolution) - Replace cascaded system receiver
5 flashes	The cascaded transmitter unit is not correctly connected or is defective.	<ul style="list-style-type: none"> - Check connection and configuration of the cascaded transmitter (protection field height and resolution) - Replace cascaded system transmitter

6.3 Extended diagnostic

By means of the optional configuration software and the NSR-0700 BUS converter, an extended diagnostic can be executed. The software provides the status information of the component and can represent the individual light lines. This feature enables an optimal adjustment of the light curtain. The diagnostic mode is signalled by the OSSD ON and OSSD OFF LED's at the receiver. In diagnostic mode, protective mode is disabled, the ODDS outputs being locked. The change from diagnostic mode to protective mode is automatically realised after Power Reset, when the BUS converter is no longer integrated and the connecting cable of the sensor is reconnected.

7. Disassembly and disposal

7.1 Disassembly

The safety switchgear must be disassembled in a de-energised condition only.

7.2 Disposal

The safety switchgear must be disposed of in an appropriate manner in accordance with the national prescriptions and legislations.

8. Appendix

8.1 Contact

Consultancy / Sales:



K.A. Schmersal GmbH
Industrielle Sicherheitssysteme
Möddinghofe 30
D-42279 Wuppertal
Tel:+49 (0) 202 64 74 -0
Fax:+49 (0) 202 64 74- 100

You will also find detailed information regarding our product variety on our website: www.schmersal.com

Repair handling / shipping:

Safety Control GmbH
Am Industriepark 11
D-84453 Mühldorf / Inn
Tel.: +49 (0) 8631-18796-0
Fax: +49 (0) 8631-18796-1

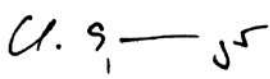
8.2 EC Declaration of conformity

EC Declaration of conformity		 SCHMERSAL safety control
Translation of the original declaration of conformity Safety Control GmbH Am Industriepark 33 84453 Mühldorf / Inn Germany Internet: www.schmersal.com		
We hereby certify that the hereafter described safety components both in its basic design and construction conform to the applicable European Directives.		
Name of the safety component / type:	SLC 220 SLG 220	
Description of the safety component:	Safety light curtain / safety light grid	
Harmonised EC-Directives:	2006/42/EC EC-Machinery Directive 2004/108/EC EMC-Directive	
Applied standards:	EN 61496-1:2004 + A1 2008 CLC/TS 61496-2:2006 EN ISO 13849-1:2008; PL d EN 62061:2005; SIL 2	
Person authorized for the compilation of the technical documentation:	Ulrich Loss Möddinghofe 30 42279 Wuppertal	
Notified body for the prototype test:	TÜV Nord Cert GmbH Langemarckstr.20 45141 Essen ID n°: 0044	
EC-prototype test certificate:	n° 44 205 10 555867 004	
Place and date of issue:	Wuppertal, February 1, 2010	
SLC 220-B-EN		
	Authorised signature Christian Spranger Managing Director	Authorised signature Klaus Schuster Managing Director



The currently valid declaration of conformity can be downloaded from the internet at www.schmersal.net.



Safety Control GmbH
Am Industriepark 33
D-84453 Mühldorf / Inn

Telefon +49 - (0)86 31 - 187 - 9 60
Telefax +49 - (0)86 31 - 187 - 9 61
E-Mail: info@safetycontrol.com