



EN Operating instructions. pages 1 to 18
Original

Content

1 About this document

1.1 Function. 1

1.2 Target group: authorised qualified personnel 1

1.3 Explanation of the symbols used. 1

1.4 Appropriate use. 2

1.5 General safety instructions 2

1.6 Warning about misuse. 2

1.7 Exclusion of liability. 2

2 Product description

2.1 Destination and use. 2

2.2 Ordering code 2

2.3 Special versions 2

2.4 Scope of delivery and accessories 2

2.4.1 Accessories included in delivery 2

2.4.2 Optional accessories. 2

2.5 Technical data 3

2.6 Response time (reaction time) 3

2.7 Safety classification. 4

2.8 Functions. 4

2.8.1 Protective mode / Automatic 4

2.8.2 Restart Interlock (operation) 4

2.8.3 Restart interlock with double acknowledgement/reset 5

2.8.4 Fixed blanking 5

2.8.5 Fixed blanking with movable edge region 5

2.8.6 Floating blanking 6

2.8.7 Contactor control (EDM) 7

2.8.8 Rotating the display through 180 degrees. 7

2.9 Self-test. 7

2.10 Beam coding A. 7

2.11 Parameter setting 7

3 Mounting

3.1 General conditions 9

3.2 Protection field and approach 9

3.3 Alignment of the sensors. 9

3.4 Setting mode 9

3.5 Safety distance 10

3.5.1 Minimum distance to reflecting surfaces. 11

3.6 Dimensions transmitter and receiver 12

3.7 Fixing. 13

4 Electrical connection

4.1 Wiring example 14

4.2 Wiring example SLC440 15

4.3 Connector configuration Receiver, Transmitter & Cable 15

5 Set-up and maintenance

5.1 Check before start-up 15

5.2 Maintenance 15

5.3 Regular check 16

5.4 Half-yearly inspection 16

5.5 Cleaning 16

6 Diagnostic

6.1 Status information LED 16

6.2 Fault diagnostic 17

7 Disassembly and disposal

7.1 Disassembly 17

7.2 Disposal. 17

8 Appendix

8.1 Contact 17

9 EU Declaration of conformity

1. About this document

1.1 Function
This operating instructions manual provides all the information you need for the mounting, set-up and commissioning to ensure the safe operation and disassembly of the safety switchgear. The operating instructions must be available in a legible condition and a complete version in the vicinity of the device.

1.2 Target group: authorised qualified personnel
All operations described in this operating instructions manual must be carried out by trained specialist personnel, authorised by the plant operator only.

Please make sure that you have read and understood these operating instructions and that you know all applicable legislations regarding occupational safety and accident prevention prior to installation and putting the component into operation.

The machine builder must carefully select the harmonised standards to be complied with as well as other technical specifications for the selection, mounting and integration of the components.

1.3 Explanation of the symbols used

 **Information, hint, note:**
This symbol is used for identifying useful additional information.

 **Caution:** Failure to comply with this warning notice could lead to failures or malfunctions.
Warning: Failure to comply with this warning notice could lead to physical injury and/or damage to the machine.

1.4 Appropriate use

The products described in these operating instructions are developed to execute safety-related functions as part of an entire plant or machine. It is the responsibility of the manufacturer of a machine or plant to ensure the correct functionality of the entire machine or plant.

The safety switchgear must be exclusively used in accordance with the versions listed below or for the applications authorised by the manufacturer. Detailed information regarding the range of applications can be found in the chapter "Product description".

1.5 General safety instructions

The user must observe the safety instructions in this operating instructions manual, the country-specific installation standards as well as all prevailing safety regulations and accident prevention rules.



Further technical information can be found in the Schmersal catalogues or in the online catalogue on the Internet: www.schmersal.net.

The information contained in this operating instructions manual is provided without liability and is subject to technical modifications.



The entire concept of the control system, in which the safety component is integrated, must be validated to EN ISO 13849-2.

There are no residual risks, provided that the safety instructions as well as the instructions regarding mounting, commissioning, operation and maintenance are observed.

Additional measures could be required to ensure that the system does not present a dangerous breakdown, when other forms of light beams are available in a special application (e.g. use of wireless control devices on cranes, radiation of welding sparks or effects of stroboscopic lights).

1.6 Warning about misuse



In case of improper use or manipulation of the safety switchgear, personal hazards or damages to machinery or plant components cannot be excluded when safety switchgear is used. The relevant requirements of the standards EN ISO 13855 & EN ISO 13857 must be observed.



Only if the information described in this operating instructions manual are realised correctly, the safety function and therefore the compliance with the Machinery Directive is maintained.

1.7 Exclusion of liability

We shall accept no liability for damages and malfunctions resulting from defective mounting or failure to comply with this operating instructions manual. The manufacturer shall accept no liability for damages resulting from the use of unauthorised spare parts or accessories.

For safety reasons, invasive work on the device as well as arbitrary repairs, conversions and modifications to the device are strictly forbidden; the manufacturer shall accept no liability for damages resulting from such invasive work, arbitrary repairs, conversions and/or modifications to the device.

2. Product description

2.1 Destination and use

The SLC440 is a non-contact, self-testing safety guard, which is used for the protection of hazardous points, hazardous areas and machine accesses. If one or more light beams are interrupted, the hazardous movement must be stopped.



The user must evaluate and design the safety chain in accordance with the relevant standards and the required safety level.

2.2 Ordering code

This operating instructions manual applies to the following types:

SLC440-ER-①-②-01

No.	Option	Description
①	xxxx	Protection field heights in mm available lengths: 0170, 0250, 0330, 0410, 0490, 0570, 0650, 0730, 0810, 0890, 0970, 1050, 1130, 1210, 1290, 1370, 1450, 1530, 1610, 1690, 1770, 1850, 1930
②	14 30	Resolution 14 mm with a range of 0.3 m ... 7 m Resolution 30 mm with a range of 0.3 m ... 10 m

-01 = integrated status indication (option)

2.3 Special versions

For special versions, which are not listed in the order code, these specifications apply accordingly, provided that they correspond to the standard version.

2.4 Scope of delivery and accessories

2.4.1 Accessories included in delivery

Mounting kit MS-1100

The kit comprises 4 rotating mounting angles and 8 mounting screws for fixing to the end caps.

MSD5 spacer

The kit comprises 2 spacers and is included in delivery as of a protection field height of 1050 mm. The spacers must be used in case of vibrations.

2.4.2 Optional accessories

Centre support MS-1110

Consisting of 2 steel brackets and 4 spacers

Connecting cable for transmitter			
Item No	Designation	Description	Length
101207741	KA-0804	Female connector M12, 4-pole	5 m
101207742	KA-0805	Female connector M12, 4-pole	10 m
101207743	KA-0808	Female connector M12, 4-pole	20 m

Connecting cable for Receiver			
Item No	Designation	Description	Length
101207728	KA-0904	Female connector M12, 8-pole	5 m
101207729	KA-0905	Female connector M12, 8-pole	10 m
101207730	KA-0908	Female connector M12, 8-pole	20 m

Adapter cable for parameter setting			
Item No	Designation	Description	Length
101217615	KA-0974	Y-distributor with command device	1 m

Test rod PLS

The test rod is used for testing the protection field.

MSD4 Vibration damper

Kit consists of: 8 vibration dampers 15 x 20 mm, 8 M5 cylinder head screws with hexagon socket, 8 spring washers. Mounting using MS-1100.

The MSD4 vibration damper kit is recommend to be used for damping vibrations and oscillations on the SLC440. For applications with higher mechanical stresses, e.g. presses, punching machines, we recommend the MSD4 kit. In this way, the availability of the SLC440 is increased.

Integrated status indication

The SLC440 series is also available with integrated status indication (red/yellow/green) installed onto the receiver. (See ordering code)

2.5 Technical data

Standards:	EN 61496-1; EN 61496-2; EN ISO 13849; EN 62061
Material of the enclosure:	Aluminium
Protection field heights:	
- Resolution 14 mm	170 mm - 1930 mm
- Resolution 30 mm	170 mm - 1930 mm
Detection ability for test bodies:	14 mm and 30 mm
Range of the protection field:	
- Resolution 14 mm	0.3 ... 7.0 m
- Resolution 30 mm	0.3 ... 10.0 m
Response time:	
- beam coding (normal)	1 - 48 beams = 10 ms 49 - 144 beams = 20 ms 145 - 192 beams = 28 ms
- beam coding A	1 - 48 beams = 15 ms 49 - 144 beams = 27 ms 145 - 192 beams = 40 ms
Rated operating voltage:	24 VDC \pm 10% (PELV) supply unit I_{max} 2.0 A, to EN 60204 (power drop \leq 20 ms)
Rated operating current:	250 mA max. + 2 x 0.25 A each OSSD
Wavelength of the infrared radiation:	880 nm
Transmitter, infrared emitted radiation	
- to DIN EN 12198-1:	Category 0
- to DIN EN 62471:	free group
Safety outputs	
OSSD1, OSSD2:	2 x short-circuit proof PNP semi-conductor outputs
Test impulse cycle OSSD:	750 ms
Test impulse length:	100 μ s
Switching voltage HIGH ¹ :	15 ... 26.4 V
Switching voltage LOW ¹ :	0 ... 2 V
Switching current each OSSD:	0 ... 250 mA
Leakage current ² :	1 mA
Load capacity:	0 ... 2.2 μ F
Load inductivity ³ :	0 ... 2H
Admissible conduction resistance between OSSD and load:	2.5 Ω
Admissible conduction resistance of the supply cable:	1.5 Ω
Contact control (EDM)	
Input voltage HIGH (inactive):	11 ... 30 V
Input voltage LOW (active):	0 ... 2.0 V
Input current HIGH:	3 ... 10 mA
Input current LOW:	0 ... 2 mA
Input release restart interlock/restart interlock 2	
Input voltage HIGH (active):	11 ... 30 V
Input voltage LOW (inactive):	0 ... 2.0 V
Input current HIGH:	3 ... 10 mA
Input current LOW:	0 ... 3 mA
Functions:	automatic mode, restart interlock, double reset, contactor control, beam blanking fixed and floating, beam coding A

Signal times

Contact control:	max. 500 ms
Restart interlock (manual reset):	50 ms ... 1.5 s, signal transmission in case of trailing edge
LED indications transmitter:	transmitting, status
LED indications receiver:	OSSD ON, OSSD OFF, restart, signal reception, blanking, information
Connection:	M12 connector plug with metal thread, receiver 8-pole, transmitter 4-pole
Ambient temperature:	-25° C ... + 50° C; at -25° C: Reduction of range by -10%
Storage temperature:	-25° C ... + 70° C
Interface:	Diagnostics and function setting
Protection class:	IP67 (IEC 60529)
Resistance to vibration:	10 ... 55 Hz to IEC 60068-2-6
Resistance to shock:	10 g, 16 ms, to IEC 60028-2-29
Year of construction:	as of 2014 version 2.0

¹⁾ To IEC 61131-2

²⁾ In case of failure, the leakage current at the most flows to the OSSD cable. The downstream control element must recognise this state as LOW. A safety PLC must detect this state.

³⁾ The load inductivity generates an induced voltage during the switch-off, which compromises the downstream components (spark quenching element).

2.6 Response time (reaction time)

The response time depends on the height of the protection field, the resolution, the number of light beams and the beam coding A.

Resolution 14 mm				
Protection field height [mm]	Beams (Lines) [Number]	Response time [ms]	Response time with Beam coding A [ms]	Weight [kg]
170	16	10	15	0.4
250	24	10	15	0.5
330	32	10	15	0.6
410	40	10	15	0.8
490	48	10	15	0.9
570	56	20	27	1.0
650	64	20	27	1.1
730	72	20	27	1.2
810	80	20	27	1.4
890	88	20	27	1.5
970	96	20	27	1.6
1050	104	20	27	1.7
1130	112	20	27	1.8
1210	120	20	27	2.0
1290	128	20	27	2.1
1370	136	20	27	2.2
1450	144	20	27	2.3
1530	152	28	40	2.4
1610	160	28	40	2.6
1690	168	28	40	2.7
1770	176	28	40	2.8
1850	184	28	40	2.9
1930	192	28	40	3.0

Resolution 30 mm				
Protection field height [mm]	Beams (Lines) [Number]	Response time [ms]	Response time with Beam coding A [ms]	Weight [kg]
170	8	10	15	0.4
250	12	10	15	0.5
330	16	10	15	0.6
410	20	10	15	0.8
490	24	10	15	0.9
570	28	10	15	1.0
650	32	10	15	1.1
730	36	10	15	1.2
810	40	10	15	1.4
890	44	10	15	1.5
970	48	10	15	1.6
1050	52	20	27	1.7
1130	56	20	27	1.8
1210	60	20	27	2.0
1290	64	20	27	2.1
1370	68	20	27	2.2
1450	72	20	27	2.3
1530	76	20	27	2.4
1610	80	20	27	2.6
1690	84	20	27	2.7
1770	88	20	27	2.8
1850	92	20	27	2.9
1930	96	20	27	3.0

2.7 Safety classification

Standards:	EN ISO 13849-1, EN 62061
PL:	up to e
Control category:	up to 4
PFH value:	$5.14 \times 10^{-9} / h$
SIL:	up to 3
Service life:	20 years

2.8 Functions

The system consists of a receiver and a transmitter. For the described functions, no further switching elements are required. The diagnostic and function selection takes place with a command device (key release), refer to the chapter on parameterisation.

The system has the following features:

- Protective mode automatic (automatic start after release of the protection zone)
- Restart Interlock (manual reset)
- Double acknowledgement/reset
- Contactor control (EDM)
- Beam coding A
- Blanking of fixed protection field areas
- Blanking of fixed protection field areas with movable edge region
- Blanking of movable protection field areas

Factory setting

The system features many functions without needing any additional devices. The following table gives an overview of the possible functions and the factory settings configuration.

Function	Factory setting	Configuration
Protective mode, automatic	not active	External wiring
Restart interlock (manual reset)	not active	External wiring
Double acknowledgement/reset	not active	with command device
Blanking fixed/floating	not active	with command device
Contactor control (EDM)	not active	with command device
Beam coding A	not active	with command device



By default neither the restart interlock (manual reset) nor the protective mode is active. One of both operating modes must be wired in order to enable the OSSD outputs. If no operating mode is selected, the following message is shown:
Status indication E1 + LED OSSD OFF (red)

2.8.1 Protective mode / Automatic

The protective mode switches the OSSD outputs to the ON state (protection field not interrupted), without external release of a switching device.

Wiring of the receiver

Jumper connection
pin 1 with pin 6

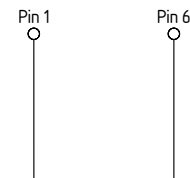

This operating mode generates an automatic restart of the machine if the protection field is not interrupted.



A 24 VDC H-signal at the input of pin 1 leads to a restart of the system. If the 24 VDC H-signal is still present at pin 1 after the self-test, the system switches to setting mode, see chapter "Setting mode".



This operating mode may only be chosen in conjunction with the restart interlock (manual reset) of the machine. This operating mode must not be chosen, when persons can step behind the protection field.

2.8.2 Restart Interlock (operation)

The restart interlock (manual reset) prevents an automatic enabling of the outputs (OSSD's ON state) after switch-on of the operating voltage or an interruption of the protection field. The system switches the outputs only to ON state, when an external command device (restart button) generates an enabling signal at the restart input (receiver).

Wiring of the receiver

- Jumper connection pin 5 with pin 6
- Command device (enabling button) at pin 1

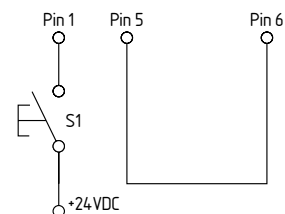

The command devices (enabling button) must be installed outside of the hazardous area. The operator must have a clear view on the hazardous area when actuating the enabling button.

2.8.3 Restart interlock with double acknowledgement/reset

In applications with access monitoring, a complete overview of the hazardous areas is often not possible; despite that, a reset of the command device for the restart interlock outside of the hazardous area by third parties is at all times enabled, although possible persons/operators are in the invisible area. This hazardous situation can be avoided by means of a double reset, i.e. integration of two command devices inside and outside the hazardous area.



Wiring of the receiver

- Command device S1 at pin 1
- Command device S2 at pin 5
- Pin 6, no signal (input open)

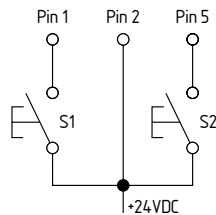

Specification

The operating mode is available, when the parameter setting - double reset is activated (P 5). See chapter Parameter setting.

Sequence for enabling:

- 1) Actuate command device inside of the hazardous area (S2) and leave the hazardous area
- 2) Go through protected field or interrupt at least one beam, then release protected field
- 3) Actuate the command device outside of the hazardous area (S1)

Command device S1 can be reset (acknowledged) within a timeframe of 2 to 60 seconds after the actuation of S2. If the order or the time requirement is not respected, the process must be repeated.

Signalling: LED restart (yellow)

Status	Note
On	Release of S2 (restart interlock 2) waiting for signal
Flashing	Release of S1 (restart interlock) waiting for signal

2.8.4 Fixed blanking

The SLC440 can blank stationary objects in the protection field.

Multiple protection field areas can be blanked. If small changes are made within the fixed blanking area, each time 1 beam can be additionally blanked to increase the tolerance. See chapter Parameter setting - Fixed blanking with movable edge regions (P 2).

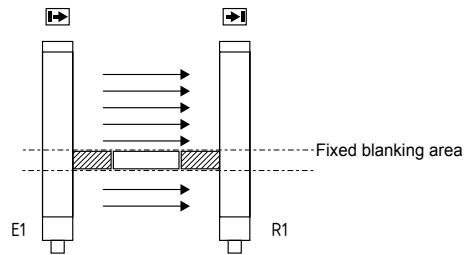

Key

- Object in protection field
- mechanical cover

The range of the fixed blanking can be arbitrarily chosen in the protection field.

The first beam line, which realises the optical synchronisation and is located immediately behind the diagnostic window, cannot be blanked.

The area of the fixed blanking must not be modified after the teach-in process. Any change of the area or removal of the object from the protection field will be detected by the system. As a result, the outputs are disabled (locked). This locking can be neutralised by executing a new teach-in process in accordance with the actual beam interruptions.



The function is activated by means of the parameter setting (P1). If the function is activated, the LED blanking in the diagnostic window of the receiver starts flashing. See chapter Parameter settings.



- The remaining lateral areas must be protected against intrusion by means of mechanical covers.
- The lateral covers must be fixed with the object.
- Partial covers are not authorised.
- After the fixed blanking, the protection field must be tested by means of the test rod.
- The restart interlock function of the safety light curtain or the machine must be activated.

2.8.5 Fixed blanking with movable edge region

This function can compensate slight position changes of one fixed blanked object with a change of ± 1 beam. This position change corresponds to an amplitude of approx. ± 10 mm resolution 14 mm and approx. ± 20 mm resolution 30 mm upwards and downwards in the protection field.

Example of beam blanking (object in protection field)

Beam number	3	4	5	6	7	Status OSSDs
Fixed blanking, beam 4, 5 and 6	○	●	●	●	○	Teach In
Shift 1 beam down	●	●	●	○	○	ok
Shift 1 beam up	○	○	●	●	●	ok
Object only covers 2 beams	○	○	●	●	○	ok
Object only covers 2 beams	○	●	●	○	○	ok
Object with downward edge displacement	●	●	●	●	○	ok
Object with upward edge displacement	○	●	●	●	●	ok
Object displacement exceeds 1 beam	○	○	○	●	●	Error
Object size changed (1 beam)	○	○	●	○	○	Error
Object size changed (5 beams)	●	●	●	●	●	Error

The operating mode is only available, when the parameter setting - fixed blanking with movable edge region is activated (P 2).

See chapter Parameter setting.

A combination with only fixed beam blanking (P 1) or additional floating beam blanking (P 3) is not possible.

This blanking changes the physical resolution. The effective resolution of the SLC440 can be found in the table in the chapter "Floating blanking" (1 beam).



Perform a new calculation of the safety distance with the effective resolution. Adjust the safety distance in accordance with your calculation!

2.8.6 Floating blanking

The SLC440 safety light curtain can blank movable objects in the protection field.

The SLC440 can be used for the floating blanking of 2 beams in the protection field, refer to parameter setting (P 3). A combination of fixed and floating beam blanking (P 1 and P 3) is enabled.

A combination of fixed blanking with movable edge region (P 2) and floating blanking (P 3) is not possible.

**Example
Floating and fixed blanking**

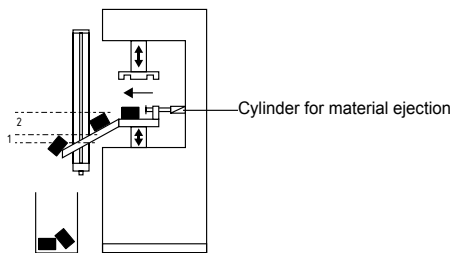

Key

- 1: Fixed blanking area
- 2: Floating blanking area

The function enables an arbitrary floating blanking of partial areas in the protection field. The first beam, which is located immediately behind the diagnostic window, cannot be blanked.

This function allows for an interruption of the protection height without the outputs being disabled in case of material movement in the protection field, e.g. material ejection or process-controlled material movement. material ejection or process-controlled material movement without the outputs being disabled in case of material movement in the protection field g. material ejection or process-controlled material movement. This extension of the object detection increases the resolution. In this way, the physical resolution changes into an effective resolution. This effective resolution must be used to calculate the safety distance. Use formula (1) to calculate the safety distance with the effective resolution if a maximum of 2 light beams are blanked; use formula (3) indicated in the "Safety distance" chapter if more than 2 light beams are blanked.

The number of beams to be blanked is limited, see Table Effective resolution.

In a system with a 14 mm physical resolution, the effective resolution is increased to 34 mm in case of a floating blanking of 2 beams. The effective resolution must be registered permanently and clearly visible onto the label affixed to the receiver.

Effective resolution

The effective resolution in case of activated blanking can be found in the following table.

Resolution 14 mm		
Blanked beams	Physical resolution	Effective resolution
1	14	24
2	14	34

Resolution 30 mm		
Blanked beams	Physical resolution	Effective resolution
1	30	48
2	30	68



The function is activated in parameter setting mode (P 3). If the function is activated, the LED blanking in the diagnostic window of the receiver starts flashing.



Perform a new calculation of the safety distance with the effective resolution. Adjust the safety distance in accordance with your calculation.



The standard IEC/TS 62046 includes information, which describes possibly required additional measures to prevent a person from reaching a hazard through the blanking areas of a protection field.

2.8.7 Contactor control (EDM)

The contactor control monitors the controlled switching elements (auxiliary contacts of the contactors) of both outputs. This monitoring is realised after each interruption of the protection field and prior to the restart (enabling) of the outputs. In this way, malfunctions of the contactors are detected, e.g. contact welding or contact spring breakage. If the light curtain detects a malfunction of the switching elements, the outputs are locked. After elimination of the error, a power reset is required.



The contactor control is not activated upon delivery. The function is activated in parameter setting mode (P 4).

Connection EDM

Wiring of the receiver

- Kn1, Kn2 = auxiliary contact of the last switching relay

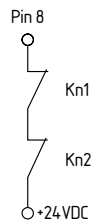

The auxiliary contacts must only be connected, when the function is activated!

2.8.8 Rotating the display through 180 degrees

The orientation of the 7 segment display can be rotated through 180 degrees via the software option. This ensures that the display remains readable in rotated mounting positions of the AOPD.

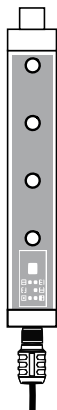

Parameter P 7 –
Display normal orientation

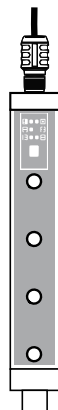

Parameter P 7 A
Display rotated

2.9 Self-test

The system performs a complete self-test and safety test within 2 seconds after the operating voltage has been switched on. If the protection field is free, the system switches to the ON condition (automatic mode). In case of an error, the outputs at the receiver do not switch to the ON state. An error message is emitted in the form of an error code. For more information, refer to chapter Fault diagnosis.

During operation, the system executes a cyclic self-test. Safety-relevant faults are detected within the reaction time and cause the outputs to be switched off and an error code to be emitted.

2.10 Beam coding A

The preset beam coding of the safety light curtain must be adjusted, when systems operating in each other's vicinity and a set-up as shown in the image below (no interference) is impossible. When supplied, the beam coding A is **not active**. A receiver with activated beam coding A can distinguish the beams of the transmitter with the same beam coding, which are destined to this particular receiver, from foreign beams.

If adjacent systems are operated without beam coding A, the user is at risk.

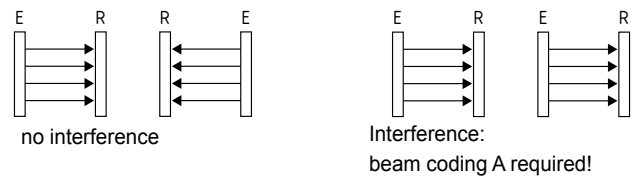

- The beam coding A avoids mutual interference of adjacent systems.
- The beam coding A is permanently shown by the transmitter and the receiver by means of flashing LED's (refer to LED status information).
- The beam coding A must be set for **each sensor** (receiver and transmitter) individually.
- The function at the receiver is activated in parameter setting mode (P 6).

Transmitter parameter setting

Wiring of the transmitter

Jumper connection
pin 1 with pin 2
Jumper connection
pin 3 with pin 4

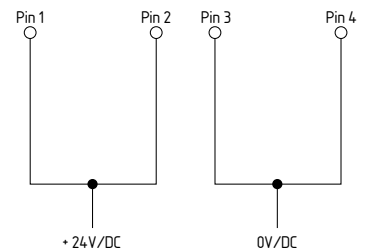

The response time of the system is increased when beam coding A is used. To this end, the safety distance must be adjusted. Refer to chapter: Response time.

2.11 Parameter setting

The parameter setting of the SLC440 enables the individual adjustment of the desired functionality to the application.

Parameter display (7-segment display)

- A = parameter active
- = parameter not active
- S. = save the current configuration
- C. = delete the current configuration, new configuration = factory setting
- n = unavailable (unauthorised setting, refer to Parameter setting information)
- d. = diagnostic/setting mode

Parameter selection

Selection, change and acceptance of the parameters by means of the command device pushbutton S1:

- Switch to parameter setting Px briefly press the button 0.1 ... 1.5 sec.
- Change parameter setting Px press button 2.5 ... 6 sec.
- Save S. /Factory setting C. press button 2.5 ... 6 sec.

Procedure

- 1) For the parameter setting, the receiver must be isolated from the operating voltage. In de-energised condition, the following jumper connection and the pushbutton S1 must be connected.

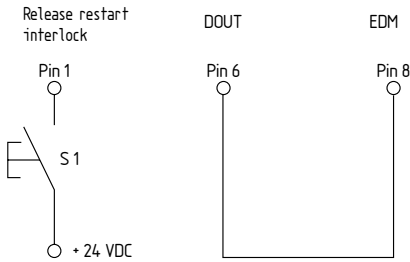

Wiring of the receiver

- Jumper connection from DOUT (Pin 6) to EDM (Pin 8)
 - Connection of the command device pushbutton S1 (+24 VDC) on Pin 1 (restart interlock)
 - Possible jumper connections from Pin 5 to Pin 6 or Pin 1 to Pin 6 must be removed. If the EDM function was activated, the auxiliary contact of Pin 8 must be removed.
- 2) The receiver switches to parameter setting mode when the operating voltage is switched on.

The operating status is signalled in the following way

	7- segment display
	LED OSSD ON (red) active
	LED OSSD OFF (green) active

Parameter setting

- 1) When S1 is briefly pressed, the display shows **repeatedly**

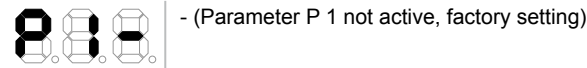

- 2) Select the desired parameter by means of command device S1 (briefly press the button)
- 3) Select the desired parameter by means of the command device (press the button for a long time)
 1. Push button (approx. 2.5 seconds) → - flashes (parameter not active)
 2. Enable button when → **A** static (parameter active)
- 4) Save the new configuration with the parameter Save **S**. (push the button for a long)
 1. Actuate button (approx. 2.5 seconds) → **S**. flashes
 2. Enable button when → **S**. static
 3. Automatic restart → "segment circulation" then P is displayed (saving operation successful)

If no restart takes place (**S**.), the saving operation has not been successful (i.e. the parameter changes have not been saved). The procedure 1 to 3 must be repeated.

All parameters can be reset to the factory setting using parameter **C**. (clear/delete).

- 1) Press the button approx. 2.5 seconds → **C**. flashes
- 2) Enable the button when → **C**. static
- 3) Automatic restart → "Segment circulation", then **P** is displayed (all parameters have been deleted)

Return to normal operating mode

1. Switch off the operating voltage at the receiver
2. Remove jumper connection at the receiver DOUT (Pin 6) and EDM (Pin 8).
3. Select the desired operating mode (jumper connections)
4. Switch operating voltage on

Adapter cable for parameter setting

If the wiring for the parameter setting of the receiver is not accessible, the KA-0974 adapter cable can be used as an alternative. The adapter cable is connected between the connecting cable and the cable connector of the receiver. The parameters are set by means of the command device (pushbutton), as described in the parameter setting. After the parameters have been set, the KA-0974 is removed and the connecting cable is connected to the receiver.

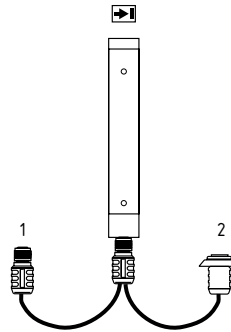

Key

- 1 = Connecting cable Receiver
- 2 = Command device pushbutton for release

Table Parameter setting

No.	Parameter	Status	Note
P 1	Fixed blanking	- = not active A = Active	Position active saves all interrupted beam through Teach-in mode
P 2	Fixed blanking with movable edge region	- = not active A = Active	Tolerance in edge region ± 1 beam - adjust safety distance!
P 3	Floating blanking 1 beam or 2 beams	- = not active 1 = 1 beam 2 = 2 beams	Blanking of max. 2 beams - adjust safety distance!
P 4	Contact control/ EDM	- = not active A = Active	The auxiliary (NC) contacts are monitored
P 5	Double acknowledgement with command device restart interlock N° 2	- = not active A = Active	Operating mode "Protective mode with double reset" restart n° 2"
P 6	Beam coding A (alternative)	- = not active A = Active	Activating upon mutual interference of identical systems
P 7	Rotating the display through 180 degrees	- = not active A = Active	The orientation of the 7 segment display can be turned through 180 degrees
S .	Save	S.	Press button S1 to save changes (2.5...6.0 sec.)
C .	Clear/delete	C.	Press button S1 to save factory setting (2.5...6.0 sec.)
d .	Diagnostic/ setting mode	d.	Switch to setting mode



P 1 oder P 2 - When fixed blanking is activated, all beams that are interrupted in the protection field at the time that command device S1 is actuated (> 2.5 sec. with trailing edge) are blanked.
 P 2 - Parameter combination P 1 and P 2 or P 2 and P 3 is not authorised. Status indication n = not available
 P 6 - Beam coding A must also be set at the transmitter, refer to chapter Beam coding A

3. Mounting

3.1 General conditions

The following guidelines are provided as preventive warning notices to ensure a safe and appropriate handling. These guidelines are an essential part of the safety instructions and therefore must always be observed and respected.



- The SLC must not be used on machines, which can be stopped electrically in case of emergency.
- The safety distance between the SLC and a hazardous machine movement must always be observed and respected.
- Additional mechanical safety guards must be installed so that the operator has to pass by the protection field to reach the hazardous machine parts.
- The SLC must be installed so that the personnel always must be within the detection zone when operating the machine. An incorrect installation can lead to serious injuries.
- Never connect the outputs to +24VDC. If the outputs are wired to +24VDC, they are in ON state, as a result of which they are unable to stop a hazardous situation occurring on the application/machine.
- The safety inspections must be conducted regularly.
- The SLC must not be exposed to inflammable or explosive gasses.
- The connecting cables must be connected in accordance with the installation instructions.
- The fixing screws of the end caps and the mounting angle must be firmly tightened.

3.2 Protection field and approach

The protection field of the SLC consists of the entire range located between the protection field markings of transmitter and receiver. Additional protective devices must ensure that the operator has to pass by the protection field to reach the hazardous machine parts. The SLC must be installed so that personnel are always located within the detection zone of the safety device when operating the hazardous machine parts to be secure.

Correct installation

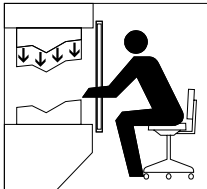

Hazardous machine parts can only be reached after passing through the protection field.

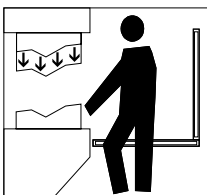

The presence of staff members between the protection field and hazardous machine parts must be prevented/avoided (protection against stepping over).

Unauthorised installation

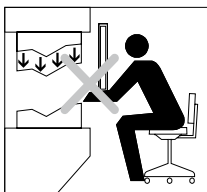

Hazardous machine parts can be reached without passing through the protection field.

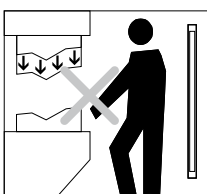

The presence of staff members between the protection field and hazardous machine parts is enabled.

3.3 Alignment of the sensors

Procedure:

1. Transmitter and receiver must be fitted parallel to each other and at the same height.
2. Choose the operating mode "Automatic" (see chapter Protective mode/automatic) and switch the operating voltage on.
3. The 7-segment display in the receiver shows the current signal quality/fine setting (signalling, see chapter "set-up mode") for 30 seconds. Rotate the transmitter and then the receiver towards each other until you have the best possible signal strength of 3 horizontal bars (7 segment display) (note that 2 horizontal bars is sufficient). Fix this position using the screws to the mounting angle. If the set-up is not possible within 30 seconds, change to set-up mode (see chapter "set-up mode").

The set-up mode leads to the best possible positioning of the sensors through the basic setting (position of the second and last beam) and the optimisation with the fine adjustment (total signal).

Status indication of the LED

OSSD ON (green) is active, signal strength (orange) is not active.

3.4 Setting mode



Setting tool with 7-segment display

The function supports the best possible alignment between transmitter and receiver. The indication shows the signal strength of the different receivers while the safety outputs are switched off. For the optical indication of the signal strength two areas are available, the signal strength of the second (with SLG first) and the last beam in the protection zone (default setting) as well as the best possible orientation of all beams (find adjustment).

Activating setting mode

After the system start, a signal impulse (H signal 24 VDC) must be present at the input restart interlock (pin 1) of the receiver for at least 2.0 seconds (pushbutton/enabling).

The 7 segment display starts with the default setting (vertical bar). The sensors are aligned in parallel and at the same height until both segments have reached a signal strength of 50% to 100%.

With a signal impulse on the input release (pin 1) you can change between default setting and fine adjustment as long as the signal strength is at 50% of the default setting (vertical bar).

After the setting of the sensors, the setting mode can be terminated by the presence of a HI-signal at pin 1 for at least 2.5 seconds (max. 6 seconds) and the actuation of the enabling button or by a voltage reset at the receiver (+UB).

Status display

The signal strength is also shown on the display in the diagnostic window by yellow light pulses to the status light. The better the alignment, the higher the frequency of the light pulses. The alignment is correct when the light pulses switch over to continuous light.

If there is no optical synchronisation between the transmitter and the receiver, a light pulse is emitted every three seconds. The setting mode is ended by a system start (+UB OFF/ON).

Alignment

Receiver not parallel

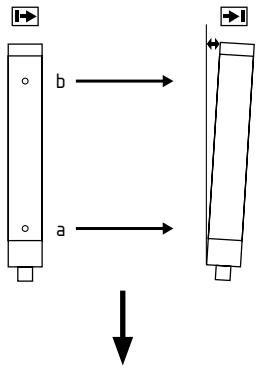

Both sensors parallel

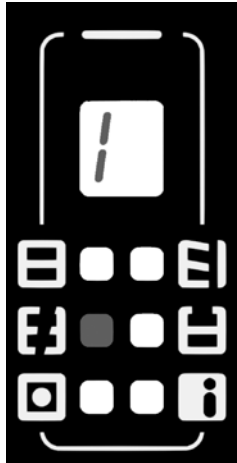
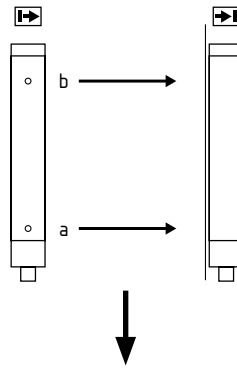

Beam (a) = receive signal OK
Beam (b) = no receive signal

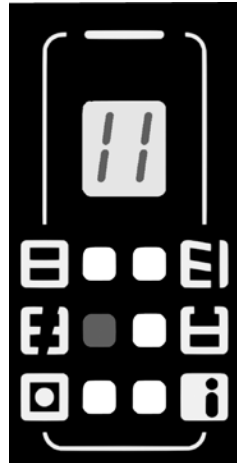

Beam (a) and beam (b)
= receive signals OK

Indication basic setting

The signal strength is displayed per beam with two segments for the 2nd (a) and the last (b) beam.

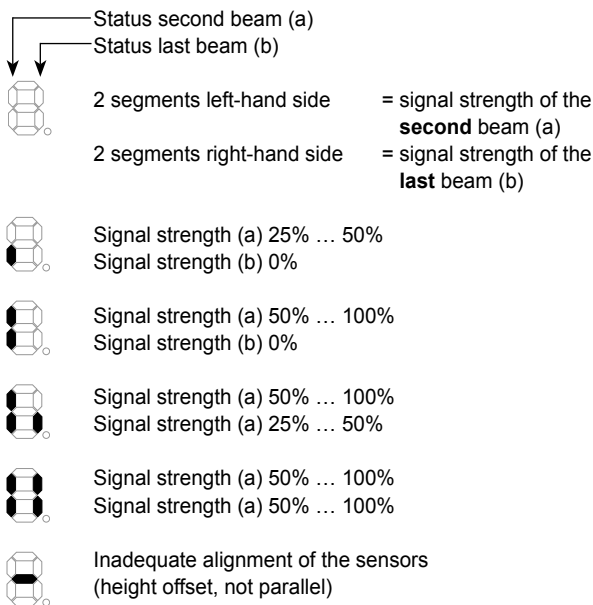

Indication fine adjustment

The fine adjustment is displayed by means of up to 3 segments (crossbars) for the best possible signal strength of all beams.

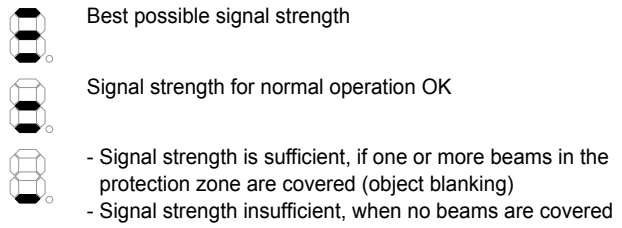

The availability of the system is also assured if due to soiling or operation at nominal range the best possible signal strength (3 segments) is not reached.

3.5 Safety distance

The safety distance is the minimum distance between the protection field of the safety light curtain and the hazardous area. The safety distance must be observed to ensure that the hazardous area cannot be reached before the hazardous movement has come to standstill.

Calculation of the safety distance to EN ISO 13855 and EN ISO 13857

The safety distance depends on the following elements:

- Stopping time of the machine (calculation by run-on time measurement)
- Response time of the machine and the safety light curtain and the downstream relay (entire safety guard)
- Approach speed
- Resolution of the safety light curtain

Safety light curtain SLC440

The safety distance for resolutions 14 mm up to 40 mm is calculated by means of the following formula:

$$(1) S = 2000 \text{ mm/s} * T + 8 (d - 14) \text{ [mm]}$$

S = Safety distance [mm]
T = Total reaction time (machine run-on time, reaction time of the safety guard, relays, etc.)
d = Resolution of the safety light curtain
The approach speed is covered with a value of 2000 mm/s
If value $S \leq 500$ mm after the calculation of the safety distance, then use this value.
If value $S \geq 500$ mm, recalculate the distance:

$$(2) S = 1600 \text{ mm/s} * T + 8 (d - 14) \text{ [mm]}$$

If the new value $S > 500$ mm, use this value as safety distance.
If the new value $S < 500$ mm, use a minimum distance of 500 mm.

Example

Reaction time of the safety light curtain = 10 ms
Resolution of the safety light curtain = 14 mm
Stopping time of the machine = 330 ms

$$S = 2000 \text{ mm/s} * (330 \text{ ms} + 10 \text{ ms}) + 8(14 \text{ mm} - 14 \text{ mm})$$

$$S = 680 \text{ mm}$$

$$S > 500 \text{ mm, therefore new calculation with } V = 1600 \text{ mm/s}$$

$$S = 544 \text{ mm}$$

The safety distance for resolution > 40 mm is calculated by means of the following formula:

$$(3) S = (1600 \text{ mm/s} \cdot T) + 850 \text{ mm}$$

S = Safety distance [mm]

T = Stopping time of the machine + reaction time of the safety light curtain

K = Approach speed 1600 mm/s

C = Safety supplement 850 mm



The safety distance between the safety light curtain and the hazardous point must always be respected and observed. If a person reaches the hazardous point before the hazardous movement has come to a standstill, he or she is exposed to serious injuries.

Safety distance to the hazardous area

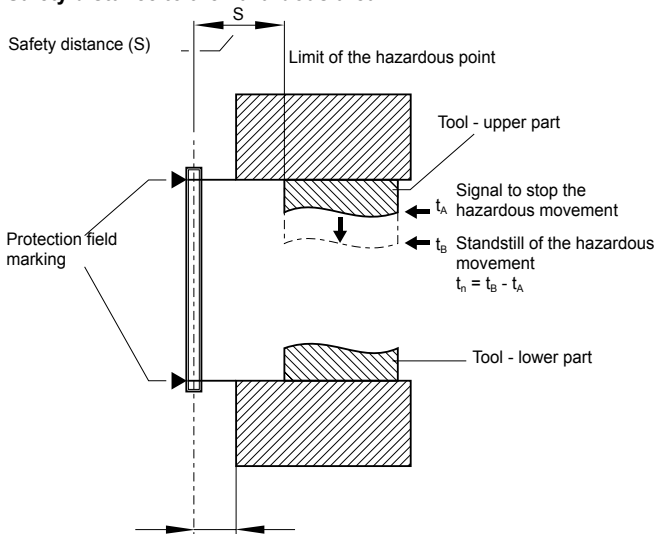

≤ 75 mm = max. distance for protection against stepping over
To prevent persons from stepping over the protection field this dimension must be imperatively respected and observed.

The formulae and calculation examples are related to the vertical set-up (refer to drawing) of the light curtain with regard to the hazardous point. Please observe the applicable harmonised EN standards and possible applicable national regulations.



To calculate the minimum distances of the safety guards with regards to the hazardous point, the EN ISO 13855 and EN ISO 13857 must be observed. If an overlap of the protection field is possible, take care with the calculation of the safety distance referring to additional CRO according to the table A1 as per norm EN ISO 13855.

3.5.1 Minimum distance to reflecting surfaces

During the installation, the effects of reflecting surfaces must be taken into account. In case of an incorrect installation, interruptions of the protection field could possibly not be detected, which could lead to serious injuries. The hereafter-specified minimum distances with regard to reflecting surfaces (metal walls, floors, ceilings or parts) must be imperatively observed.

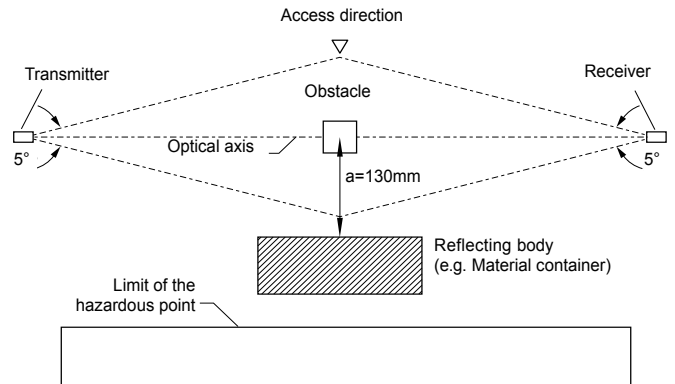

Safety distance a

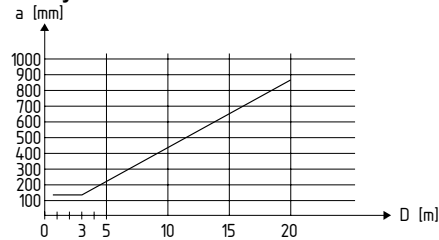

Calculate the minimum distance to reflecting surfaces as a function of the distance with an aperture angles of ± 2.5° degrees or use the value from the table below:

Distance between transmitter and receiver [m]	Minimum distance a [mm]
0.2 ... 3.0	130
4	175
5	220
7	310
10	440

Formula: $a = \tan 2.5^\circ \times L$ [mm]

a = Minimum distance to reflecting surfaces

L = Distance between transmitter and receiver

3.6 Dimensions transmitter and receiver

All measurements in mm.

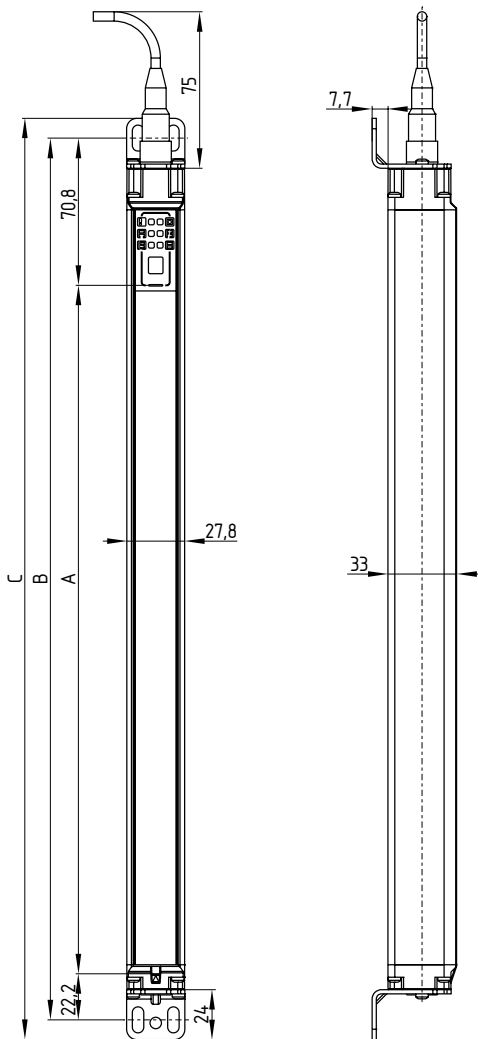

Type	A Protected height ± 1	B Mounting dimension ± 1	C Total length ± 1
SLC440-ER-0170-XX	170	264	283
SLC440-ER-0250-XX	250	344	363
SLC440-ER-0330-XX	330	424	443
SLC440-ER-0410-XX	410	504	523
SLC440-ER-0490-XX	490	584	603
SLC440-ER-0570-XX	570	664	683
SLC440-ER-0650-XX	650	744	763
SLC440-ER-0730-XX	730	824	843
SLC440-ER-0810-XX	810	904	923
SLC440-ER-0890-XX	890	984	1003
SLC440-ER-0970-XX	970	1064	1083
SLC440-ER-1050-XX	1050	1144	1163
SLC440-ER-1130-XX	1130	1224	1243
SLC440-ER-1210-XX	1210	1304	1323
SLC440-ER-1290-XX	1290	1384	1403
SLC440-ER-1370-XX	1370	1464	1483
SLC440-ER-1450-XX	1450	1544	1563
SLC440-ER-1530-XX	1530	1624	1643
SLC440-ER-1610-XX	1610	1704	1723
SLC440-ER-1690-XX	1690	1784	1803
SLC440-ER-1770-XX	1770	1864	1883
SLC440-ER-1850-XX	1850	1944	1963
SLC440-ER-1930-XX	1930	2024	2043

The overall length Ls (dimension end cap with regard to the cable connection up to the connector M12) of the sensors is calculated in the following way:

$L_s = \text{size B} - 13 \text{ mm}$

Example SLC440-ER-0970

$L_s = 1064 - 13 \text{ mm}$

$L_s = 1051 \text{ mm}$

3.7 Fixing

Included in delivery

Mounting kit MS-1100

The mounting kit consists of 4 steel angles and 8 fixing screws.

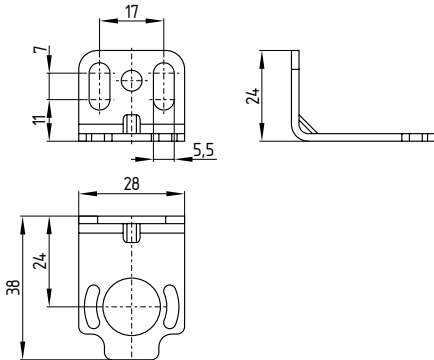

MSD5 spacer

The kit comprises 2 spacers and is included in delivery as of a protection field height of 1050 mm. The spacers must be used in case of vibrations.

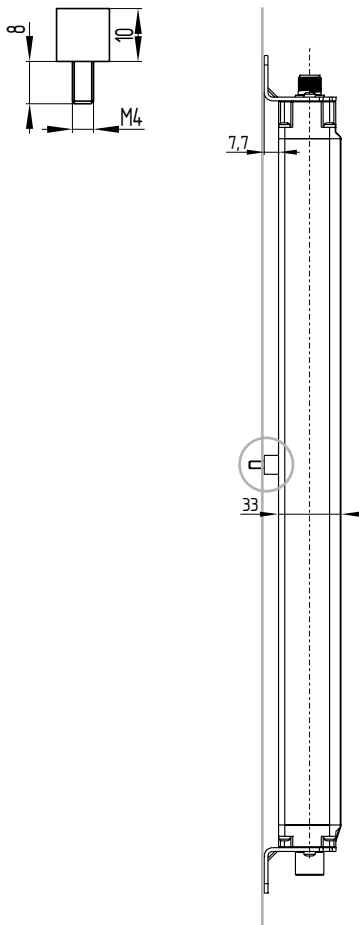

Optional accessories

Centre support MS-1110

Mounting kit consists of 2 steel angles and 4 spacers for central fixing

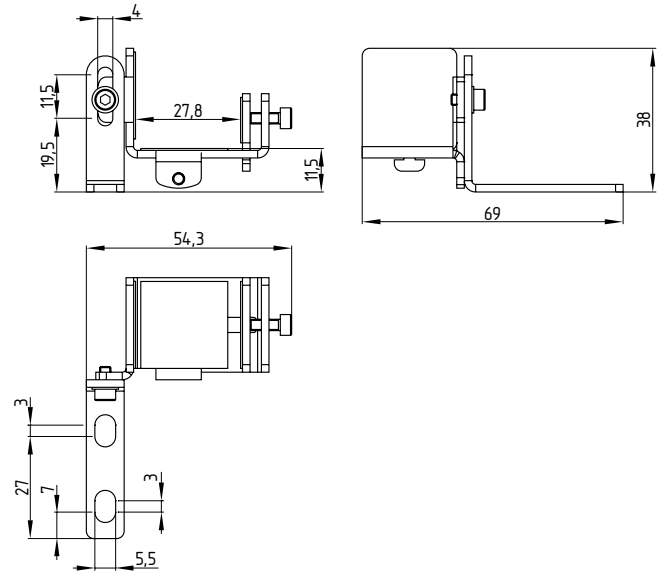

Integrated status indication

The status indication at the receiver indicates the switching condition of the outputs OSSD1 and OSSD2 and the function restart interlock / setup.

- Green = outputs H-signal 24V
- Red = outputs L-signal 0V
- Yellow = setting mode / restart interlock (manual reset)

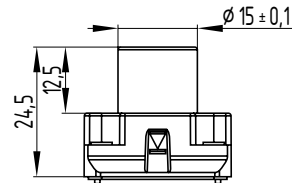

The integrated status indication **does not** change the mounting dimension B or the overall length C. The overall length of the Ls receiver changes by 10 mm.

MSD4 Vibration damper

Kit consists of: 8 vibration dampers 15 x 20 mm, 8 M5 cylinder head screws with hexagon socket, 8 spring washers. Mounting using MS-1100.

The MSD4 vibration damper kit is recommend to be used for damping vibrations and oscillations on the SLC440. For applications with higher mechanical stresses, e.g. presses, punching machines, we recommend the MSD4 kit. In this way, the availability of the SLC440 is increased.

4. Electrical connection

4.1 Wiring example

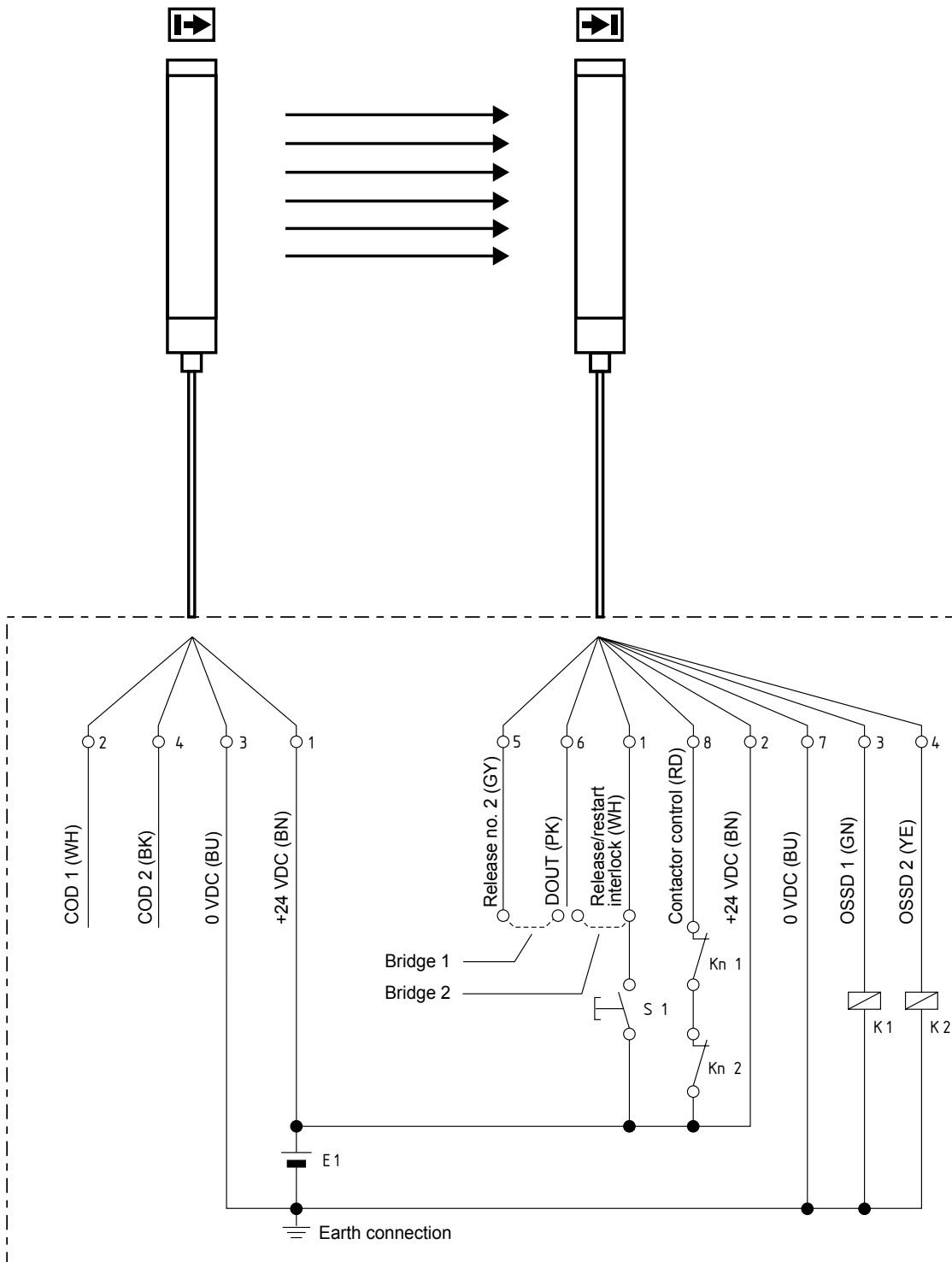

Restart interlock (manual reset) (bridge 1)
By bridging restart 2 (pin 5) and DOUT (pin 6), the restart interlock (manual reset) is activated. Connect S1 to Pin1

Protective mode / Automatic active (bridge 2)
By bridging DOUT (Pin 6) and enable restart (Pin1), the protective mode is activated. **Don't connect S1.**

- K1, K2 Relay for processing the switching outputs OSSD 1, OSSD 2
- Kn1, Kn2 Auxiliary contacts of the last switching relay (optional) signals at input EDM (Pin 8)
Only to be connected when the contactor control is activated.
- S1 Command device pushbutton for restart (optional)
- E1 Power supply 24 VDC ± 10%

4.2 Wiring example SLC440

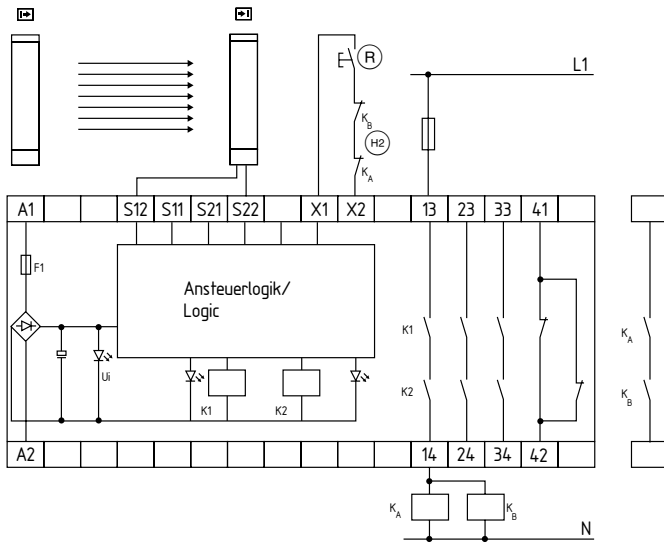

Safety monitoring module SRB 301 MC

- Contactor control K_A and K_B at X1/X2
- Command device $\text{\textcircled{R}}$ Restart interlock restart at X1/X2
- OSSD outputs at S12 and S22
- QS-switch = nQS, deactivate cross-wire short detection

4.3 Connector configuration Receiver, Transmitter & Cable

RECEIVER

SLC: Connector male M12 / 8 pol.

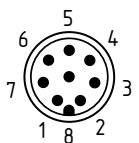

Designation	Description
1 WH	Release/restart interlock
2 BN	24 VDC
3 GN	OSSD 1
4 YE	OSSD 2
5 GY	Restart 2
6 PK	DOUT
7 BU	0 VDC
8 RD	Contactor control

Cable: Connector female M12 / 8 pole

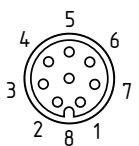

TRANSMITTER

SLC: Connector male M12 / 4 pol.

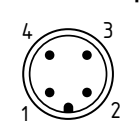

Designation	Description
1 BN	24 VDC
2 WH	COD 1
3 BU	0 VDC
4 BK	COD 2

Cable: Connector female M12 / 4 pole

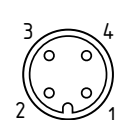

Connect COD 1 / COD 2 only when beam coding A is activated!



The colour codes are only valid for the cable types mentioned below "optional accessories".



For UL evaluated products we do recommend to use the UL style cable 20549.

5. Set-up and maintenance

5.1 Check before start-up

Prior to start-up, the following items must be checked by the responsible person.

Wiring check prior to start-up

1. The voltage supply is a 24V direct current power supply (see technical specifications), which meets the CE Directives, Low Voltage Directives. A power downtime of 20 ms must be bridged.
2. Presence of a voltage supply with correct polarity at the SLC.
3. The connecting cable of the transmitter is correctly connected to the transmitter and the connecting cable of the receiver correctly to the receiver.
4. The double insulation between the light curtain output and an external potential is guaranteed.
5. The outputs OSSD1 and OSSD2 are not connected to +24 VDC.
6. The connected switching elements (load) are not connected to +24 VDC.
7. If two or more SLC are used within close range compared to each other, an alternating arrangement must be observed. Any mutual interference of the systems must be prevented.

Switch the SLC on and check the operation in the following way

The component performs a system test during approx. 2 seconds after the operating voltage has been switched on (indication through 7-segment display). After that, the outputs are enabled, if the protection field is not interrupted. The LED "OSSD ON" at the receiver is on.



In case of incorrect functionality, please follow the instructions listed in the chapter Fault diagnostic.

5.2 Maintenance



Do not use the SLC before the next inspection is terminated. An incorrect inspection can lead to serious and mortal injuries.

Conditions

For safety reasons, all inspection results must be archived. The operating principle of the SLC and the machine must be known in order to be able to conduct an inspection. If the fitter, the planning technician and the operator are different persons, please make sure that the user has the necessary information at his disposal to be able to conduct the maintenance.

5.3 Regular check

A regular visual inspection and functional test, including the following steps, is recommended:

1. The component does not have any visible damages.
2. The optics cover is not scratched or soiled.
3. Hazardous machinery parts can only be accessed by passing through the protection field of the SLC.
4. The staff remains within the detection area, when works are conducted on hazardous machinery parts.
5. The safety distance of the application exceeds the mathematically calculated one.

Operate the machine and check whether the hazardous movement stops under the hereafter-mentioned circumstances.

1. Hazardous machine parts do not move when the protection field is interrupted.
2. The hazardous machine movement is immediately stopped, when the protection field is interrupted with the test rod immediately before the transmitter, immediately before the receiver and in the middle between the transmitter and the receiver.
3. No hazardous machine movement when the test rod is within the protection field.
4. The hazardous machine movement comes to standstill, when the voltage supply of the SLC is switched off.

5.4 Half-yearly inspection

The following items must be checked every six months or when a machine setting is changed.

1. Machine stops or does not inhibit any safety function.
2. No machine modification or connection change, which affects the safety system, has taken place.
3. The outputs of the SLC are correctly connected to the machine.
4. The total response time of the machine does not exceed the response time calculated during the first putting into operation.
5. The cables, the connectors, the caps and the mounting angles are in perfect condition.

5.5 Cleaning

If the optics cover of the sensors is extremely soiled, the OSSD outputs can be disabled. Clean with a clean, soft cloth with low pressure.

The use of aggressive, abrasive or scratching cleaning agents, which could attack the surface, is prohibited.

6. Diagnostic

6.1 Status information LED

Receiver	Function	LED colour	Description
	OSSD ON	green	Safety outputs Signal condition ON
	OSSD OFF	red	Safety outputs Signal condition OFF
	Restart	yellow	Input for command device
	Signal reception	orange	Safety-monitoring module of Signal reception
	Blanking	blue	Protection field(s) inactive (blanking)
	Information	yellow-green	Beam coding A

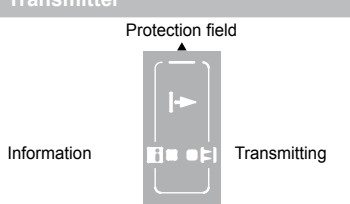





Transmitter	Function	LED colour	Description
	Information	green	Function display, Beam coding A
	Transmitting	orange	Transmitter active

Receiver LED	Status LED	Description
OSSD ON	On	Protection field clear
OSSD OFF	On	Protection field interrupted, system or configuration error
	On	Error output refer to Fault diagnostic table
	On	Restart interlock (manual reset) active, signal expected at input restart interlock
Signal reception	ON/flashing	Signal reception too low, check alignment and installation height between transmitter and receiver
		Cleaning the black profile cover
Blanking	OFF	Alignment between transmitter and receiver OK, when the OSSD are enabled
	1 flash	Fixed blanking of the protection field(s)
	2 flash	Floating blanking, max. 1 beam
	3 flash	Floating blanking, 2 beams
	4 flash	Floating (max. 1 beam) and fixed blanking of protection field(s)
	5 flash	Floating (2 beams) and fixed blanking of protection field(s)
Information	6 flash	Fixed blanking with movable edge region
	flashing	Beam coding A is active

Transmitter LED	Status LED	Description
Transmitting	On	Standard operation, transmitter active
	flashing	Configuration error
Information	flashing	Beam coding A is active

6.2 Fault diagnostic

The light curtain performs an internal self-test after the operating voltage is switched on and the protection field is enabled. When a fault is detected, an error number e.g. E1 is displayed at the receiver. Each fault display is followed by a one-second delay.

Status display	Fault feature	Action
	Wiring error, operating mode not defined (automatic or restart mode)	Check all connections at the receiver, Jumper connection 1 or jumper connection 2 present?
	Supply voltage	UB = 24V/DC ± 10%, check voltage source and primary voltage, note: after the fault message E2 has been displayed three times, a reset is executed.
	Error output (e), OSSD1 or OSSD2	Check the connections of both outputs, short-circuit of both OSSD, connection to level 0V or 24V, deactivate external (relay) cross-wire short monitoring
	Contactor control (EDM)	EDM active: check connections of both NC contacts, EDM not active: check level at Pin 8, open input
	Beam blanking	Check the blanking area(s) of fixed or floating objects with the selected parameter setting, fault elimination - repeat configuration in the parameter setting, possibly adjust P 1, P 2, P 3
	Configuration error in parameter setting	Check parameter setting and save/accept with "S." or delete/reset with "C."
	System error	Restart the system, if E 7 display persists, exchange components

The error display is reset after elimination of the error cause and after the receiver has been switched back on. The error indication displays a 3-digit system error code for every 10th display.

7. Disassembly and disposal

7.1 Disassembly

The safety switchgear must be disassembled in a de-energised condition only.

7.2 Disposal

The safety switchgear must be disposed of in an appropriate manner in accordance with the national prescriptions and legislations.

8. Appendix

8.1 Contact

Consultancy / Sales



K. A. Schmersal GmbH & Co. KG
Möddinghofe 30
D-42279 Wuppertal
Phone +49 (0) 202 64 74 -0
Fax +49 (0) 202 64 74- 100

You will also find detailed information regarding our product variety on our website: www.schmersal.com

Repair handling / shipping

Safety Control GmbH
Am Industriepark 11
D-84453 Mühldorf/ Inn
Phone +49 (0) 8631-18796-0
Fax +49 (0) 8631-18796-1

9. EU Declaration of conformity

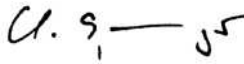
EU Declaration of conformity			
Original	Safety Control GmbH Am Industriepark 33 84453 Mühldorf / Inn Germany		
We hereby certify that the hereafter described components both in their basic design and construction conform to the applicable European Directives.			
Name of the component:	SLC440 SLG440		
Type:	See ordering code		
Description of the component:	Safety light curtain / safety light grid		
Relevant Directives:		Valid up to	Valid as of
		April 19, 2016	April 20, 2016
	Machinery Directive	2006/42/EC	2006/42/EC
	EMC-Directive	2004/108/EC	2014/30/EU
	RoHS-Directive	2011/65/EU	2011/65/EU
Applied standards:	EN 61496-1:2013, EN 61496-2:2013, EN ISO 13849-1:2008 + AC:2009, EN 62061:2005 + A1:2013		
Notified body for the prototype test:	TÜV NORD CERT GmbH Langemarckstr. 20, 45141 Essen ID n°: 0044		
EC-prototype test certificate:	44 205 13144608		
Person authorized for the compilation of the technical documentation:	Oliver Wacker Möddinghofe 30 42279 Wuppertal		
Place and date of issue:	Mühldorf, February 24, 2016		
SLC-SLC440-D-EN			
	Authorised signature Klaus Schuster Managing Director	Authorised signature Christian Spranger Managing Director	



The currently valid declaration of conformity can be downloaded from the internet at www.schmersal.net.



K. A. Schmersal GmbH & Co. KG
Möddinghofe 30, D - 42279 Wuppertal
Postfach 24 02 63, D - 42232 Wuppertal

Phone: +49 - (0)2 02 - 64 74 - 0
Telefax: +49 - (0)2 02 - 64 74 - 1 00
E-Mail: info@schmersal.com
Internet: <http://www.schmersal.com>