



EN Operating instructions. pages 1 to 18
Translation of the original operating instructions

FR Vous trouverez la version actuelle du mode d'emploi dans votre langue nationale officielle sur l'Internet, www.schmersal.net.

ES Encontrará el manual de instrucciones actual en su idioma oficial de la UE en nuestra página de Internet www.schmersal.net.

NL U vindt de huidige versie van de gebruikshandleiding in uw officiële landstaal op het Internet, www.schmersal.net.

IT Il manuale d'istruzioni aggiornato nella vostra lingua (lingua ufficiale UE) è scaricabile in Internet all'indirizzo www.schmersal.net.

JP EU公用語で書かれた最新の取扱説明書は、インターネット (www.schmersal.net) からダウンロードできます。

Content

1 About this document

1.1 Function 1

1.2 Target group: authorised qualified personnel. 1

1.3 Explanation of the symbols used 1

1.4 Appropriate use 1

1.5 General safety instructions 2

1.6 Warning about misuse 2

1.7 Exclusion of liability 2

2 Product description

2.1 Destination and use 2

2.2 Ordering code 2

2.3 Special versions 2

2.4 Scope of delivery and accessories 2

2.4.1 Accessories included in delivery 2

2.4.2 Optional accessories 2

2.5 Technical data 2

2.6 Response time (reaction time) 3

2.7 Safety classification 3

2.8 Functions 3

2.8.1 Factory setting 3

2.8.2 Restart interlock (manual reset) 3

2.8.3 Start interlock 3

2.8.4 Beam coding 4

2.8.5 Fixed blanking 4

2.8.6 Testing 4

2.9 Operating mode muting 4

2.9.1 Adequate and appropriate application 4

2.9.2 Muting sensors MS 5

2.9.3 Muting lamp 5

2.9.4 Signal sequence muting 6

2.9.5 Configuration of the muting function 6

2.9.6 Saving the data 8

2.9.7 Muting applications 8

3 Mounting

3.1 General conditions 10

3.2 Protection field and approach 10

3.3 Alignment 10

3.4 Safety distance 11

3.4.1 Minimum distance to reflecting surfaces 11

3.5 Dimensions 12

4 Electrical connection

4.1 Wiring example Muting 14

4.2 Connector configuration Receiver, Emitter & Cable. 14

5 Set-up and maintenance

5.1 Check before start-up 15

5.2 Maintenance 15

5.3 Regular check 15

5.4 Half-yearly inspection. 15

5.5 Cleaning 16

6 Diagnostic

6.1 LED status information. 16

6.2 Fault diagnostic 17

6.3 Extended diagnostic. 17

7 Disassembly and disposal

7.1 Disassembly. 17

7.2 Disposal 17

8 Appendix

8.1 Contact. 17

8.2 EC Declaration of conformity 18

1. About this document

1.1 Function

This operating instructions manual provides all the information you need for the mounting, set-up and commissioning to ensure the safe operation and disassembly of the safety switchgear. The operating instructions must be available in a legible condition and a complete version in the vicinity of the device.

1.2 Target group: authorised qualified personnel

All operations described in this operating instructions manual must be carried out by trained specialist personnel, authorised by the plant operator only.

Please make sure that you have read and understood these operating instructions and that you know all applicable legislations regarding occupational safety and accident prevention prior to installation and putting the component into operation.

The machine builder must carefully select the harmonised standards to be complied with as well as other technical specifications for the selection, mounting and integration of the components.

1.3 Explanation of the symbols used



Information, hint, note:

This symbol is used for identifying useful additional information.



Caution: Failure to comply with this warning notice could lead to failures or malfunctions.

Warning: Failure to comply with this warning notice could lead to physical injury and/or damage to the machine.

1.4 Appropriate use

The products described in these operating instructions are developed to execute safety-related functions as part of an entire plant or machine. It is the responsibility of the manufacturer of a machine or plant to ensure the correct functionality of the entire machinery or plant.

The safety switchgear must be exclusively used in accordance with the versions listed below or for the applications authorised by the manufacturer. Detailed information regarding the range of applications can be found in the chapter "Product description".

1.5 General safety instructions

The user must observe the safety instructions in this operating instructions manual, the country-specific installation standards as well as all prevailing safety regulations and accident prevention rules.



Further technical information can be found in the Schmersal catalogues or in the online catalogue on the Internet: www.schmersal.net.

The information contained in this operating instructions manual is provided without liability and is subject to technical modifications



The entire concept of the control system, in which the safety component is integrated, must be validated to EN ISO 13849-2.

There are no residual risks, provided that the safety instructions as well as the instructions regarding mounting, commissioning, operation and maintenance are observed.

Additional measures could be required to ensure that the electro-sensitive device does not present a dangerous breakdown, when other forms of light beams are available in a special application (e.g. use of wireless control devices on cranes, radiation of welding sparks or effects of stroboscopic lights).

1.6 Warning about misuse



In case of inadequate or improper use or manipulations of the safety switchgear, personal hazards or damage to machinery or plant components cannot be excluded. The relevant requirements of the standards EN ISO 13855 (successor of EN 999) and EN ISO 13857 must be observed.

1.7 Exclusion of liability

We shall accept no liability for damages and malfunctions resulting from defective mounting or failure to comply with this operating instructions manual. The manufacturer shall accept no liability for damages resulting from the use of unauthorised spare parts or accessories.

For safety reasons, invasive work on the device as well as arbitrary repairs, conversions and modifications to the device are strictly forbidden; the manufacturer shall accept no liability for damages resulting from such invasive work, arbitrary repairs, conversions and/or modifications to the device.

2. Product description

2.1 Destination and use

The SLC 425I is a non-contact, self-testing safety guard, which is used for the protection of hazardous points, hazardous areas and machine accesses. If one or more light beams are interrupted, the hazardous movement must be stopped.



The user must evaluate and design the safety chain in accordance with the relevant standards and the required safety level.

2.2 Ordering code

This operating instructions manual applies to the following types:

SLG425I-ER-①-RF

No.	Option	Description
①	0500-02	Distance between outermost beams: 500 mm, 2-beam
	0800-03	800 mm, 3-beam
	0900-04	900 mm, 4-beam



Only if the information described in this operating instructions manual are realised correctly, the safety function and therefore the compliance with the Machinery Directive is maintained.

2.3 Special versions

For special versions, which are not listed in the order code, these specifications apply accordingly, provided that they correspond to the standard version.

2.4 Scope of delivery and accessories

2.4.1 Accessories included in delivery

Mounting kit MS-1030

The kit comprises 4 rotating mounting angles and 16 mounting screws for fixing to the end caps.

2.4.2 Optional accessories

Centre fixing MS-1051

Consisting of 2 steel angles, 4 fixing screws and 4 T-slot nuts

Connecting cable for transmitter

Item number	Designation	Description	Length
101207741	KA-0804	Female connector M12, 4-pole	5 m
101207742	KA-0805	Female connector M12, 4-pole	10 m
101207743	KA-0808	Female connector M12, 4-pole	20 m

Connecting cable for receiver

Item number	Designation	Description	Length
101207728	KA-0904	Female connector M12, 8-pole	5 m
101207729	KA-0905	Female connector M12, 8-pole	10 m
101207730	KA-0908	Female connector M12, 8-pole	20 m

BUS converter NSR-0801

Converter for parametrization and diagnostics. Detailed information can be found in the operating instructions manual of the NSR-0801.

Included in delivery: integrated connecting cable, PC-software USB 2.0 connection (L x W x H, 122 x 60 x 35 mm), indications of measurements without cable

MSD4 Vibration damper

Kit consisting of: 8 vibration dampers 15 x 20 mm, 8 M5 cylinder head screws with hexagon socket, 8 spring washers

The MSD4 vibration damper kit must be used for damping vibrations and oscillations on the SLG 425I. For applications with higher mechanical stresses, e.g. presses, punching machines, we recommend the MSD4 kit. In this way, the availability of the SLG 425I is increased.

2.5 Technical data

Standards: EN 61496-1; CLC/TS 61496-2;
EN ISO 13849; EN 62061

Material of the enclosure: Aluminium

Number of beams: 2, 3, 4 beams

Protection field heights: 500 mm, 800 mm, 900 mm

Detection ability for test bodies:

2 beams with resolution 500 mm *3

3 beams with resolution 400 mm *3

4 beams with resolution 300 mm *3

Response time:	2 - 4 beams: 15 ms (Standard) 2 - 4 beams: 20 ms (beam coding A)
Range of the protection field:	0,3 m - 18 m
Rated operating voltage:	24 VDC ±10% (PELV) supply unit to EN 60204 (power drop > 20 ms)
Operating current:	400 mA max. + 0.5 A (OSSD load + output signal quality load)
Wave length of the sensor:	860 nm
Safety outputs (OSSD1, OSSD2):	2 x PNP-type semi-conductor, short-circuit proof
Switching voltage HIGH ¹ :	15 ... 28,8 V
Switching voltage LOW ¹ :	0 ... 2 V
Switching current:	0 ... 500 mA
Leakage current ² :	1 mA
Load capacity:	2 µF
Load inductance:	2 H
Admissible conduction resistance between OSSD and load:	2.5 Ω
Supply cable:	1 Ω
Input restart interlock (manual reset)	
Input voltage HIGH (active):	17 ... 29 V
Input voltage LOW (inactive):	0 ... 2.5 V
Input current HIGH:	3 ... 10 mA
Input current LOW:	0 ... 3 mA
Function:	Start and restart interlock (manual reset), fixed beam blanking and muting
Voltage:	24 VDC
Current:	500 mA
Signal times	
Restart interlock (manual reset): 50 ms ... 1.0 s signal transmission in case of trailing edge	
Start interlock:	250 ... 1500 ms, adjustable
LED indications transmitter:	Transmitting, status
LED indications receiver:	OSSD ON, OSSD OFF, restart, signal reception, blanking, multifunction
Connection:	M12 Connector plug with metal thread, receiver 8-pole, transmitter, 4-pole (male), Muting sensors 2 pc. M8 3-pole, Muting lamp M8 3 pole
Ambient temperature:	-10° C ... +50° C
Storage temperature:	-25° C ... +70° C
Interface:	Diagnostics and function setting
Protection class:	IP67 (IEC 60529)
Resistance to vibrations:	10 - 55 Hz to IEC 60068-2-6
Resistance to shock:	10 g; 16 ms; to IEC 60068-2-29
Year of construction:	as of 2010 version 1.0

¹⁾ To IEC 61131-2

²⁾ In case of failure, the leakage current at the most flows to the OSSD cable. The downstream control element must recognise this state as LOW. A safety PLC must detect this state.

³⁾ resolution = beam distance + beam diameter 10 mm

2.6 Response time (reaction time)

The response time depends on the height of the protected field, the resolution, the number of light beams and the beam coding.

Beam distance [mm]	Beams [Number]	Response time [ms]	Response time with beam coding A [ms]	Weight [kg]
500	2	15	20	2.6
400	3	15	20	3.6
300	4	15	20	3.7

2.7 Safety classification

Standards:	EN ISO 13849-1, EN 62061
PL:	up to e
Control category:	up to 4
PFH value:	7.42 x 10 ⁻⁹ / h
SIL:	up to 3
Service life:	20 years

2.8 Functions

The system consists of a receiver and a transmitter. For the described functions, no further switching elements are required. For the diagnostics and function selection, a user-friendly PC-software is offered as accessory. For the connection to a PC, the NSR-0801 BUS converter is required (not included in delivery).

The system has the following features:

- Start interlock
- Restart interlock (manual reset)
- Beam coding
- Blanking of fixed protection field areas
- Muting

2.8.1 Factory setting

The system features many functions without needing any additional devices. The following table gives an overview of the possible functions and the factory settings configuration.

Function	Factory setting	Configuration
Restart interlock (manual reset)	not active	External wiring
Fixed blanking	not active	With BUS converter NSR-0801 and PC-software
Muting	active	With BUS converter NSR-0801 and PC-software
Start interlock	not active	With BUS converter NSR-0801 and PC-software
Beam coding	not active	With BUS converter NSR-0801 and PC-software

2.8.2 Restart interlock (manual reset)

The restart interlock (manual reset) prevents an automatic enabling of the outputs (OSSD's ON state) after switch-on of the operating voltage or an interruption of the protection field.

The system switches the outputs only to ON state, when an external command device (restart button) generates an enabling signal at the restart input (receiver).



The command devices (enabling button) must be installed outside of the hazardous area. The operator must have a clear view on the hazardous area when actuating the enabling button.



In supply condition, the restart interlock (manual reset) is not active. You must select an operating mode in order for the outputs OSSD's to be enabled. If no type of protection is selected, you will obtain the following signalisation through the LED status indication in the receiver:
LED OSSD OFF (red) + LED restart (yellow) flashing

2.8.3 Start interlock

The start interlock prevents an automatic start of the machine when the supply voltage is switched on. After enabling of the start interlock - by the one-time interruption of the protection field -, this protective function is deactivated until the next power reset.



The start interlock is not activated upon delivery. This function is activated by means of the NSR-0801 BUS converter and a PC or laptop.

2.8.4 Beam coding

The beam coding of the safety light grid must be adjusted, when systems operating in each other's vicinity and a set-up as shown in the image below (no interference) is impossible. When supplied, the beam coding is not active. With beam coding A, a receiver can distinguish the beams of the transmitter with the same beam coding A, which are destined to this particular receiver, from foreign beams. The beam coding A must be set for each sensor (receiver and transmitter) individually. The function is activated by means of the NSR-0801 BUS converter and a PC or laptop.

If adjacent systems are operated without beam coding, the user is at risk.

no interference

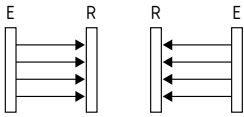

Interference: beam coding required!

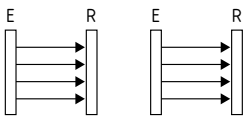

- The beam coding increases the safety and avoids mutual interference of adjacent systems.
- The beam coding increases the immunity against optical interference (e.g. sun light, welding sparks).
- The beam coding A is permanently shown by the transmitter and the receiver by means of flashing LED's (refer to LED status information).



On adjacent systems, the beam coding A must be used. The response time of the system is increased when beam coding A is used. To this end, the safety distance must be adjusted to the hazardous movement. Refer to chapter Response time.

2.8.5 Fixed blanking

The SLC 425I can blank stationary parts in the protection field.

The fixed blanking range is authorised for individual beams in case of obstacles, taking the protective function into account.

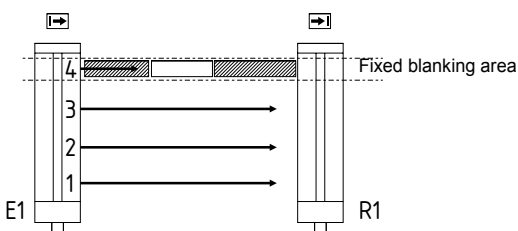

Access to lateral areas must be prevented by means of mechanical covers!

The first beam line, which realises the optical synchronisation and is located immediately behind the diagnostic window, cannot be blanked.

The area of the fixed blanking must not be modified after the teach-in process. Any change of the area or removal of the part from the protection field will be detected by the system. As a result, the outputs are disabled (locked). This locking can be neutralised by executing a new teach-in process in accordance with the actual beam interruptions.



- The blanking of beams is not authorised for an SLG 425I with 2 beams!
- The blanking of one beam at the most in the SLG 425I 3-beam version or the SLG 425I 4-beam version is authorised, provided that the protective function is taken into account.
- The blanking of multiple beams is not authorised.
- The remaining lateral areas must be protected against intrusion by means of mechanical covers.
- The lateral covers must be fixed with the object. Partial covers are not authorised.
- The restart interlock (manual reset) function of the safety light grid or the machine must be activated.



The function is activated by means of the NSR-0801 BUS converter and a PC or laptop. The activation of the function is signaled by the blanking LED flashing in the diagnostic window of the receiver.

2.8.6 Testing

The system performs a complete self-test and safety test within 2 seconds after the operating voltage has been switched on. If the protection field is not interrupted, the system switches to the ON condition. In case of an error, the outputs at the receiver do not switch to the ON state. The LED OSSD OFF starts flashing, thus emitting an error message. Further indications can be found in the chapter Fault diagnostic. During operation, the system continuously executes a self-test. Safety-relevant faults are detected within the cycle time and cause the outputs to be switched off.

2.9 Operating mode muting

2.9.1 Adequate and appropriate application

The objective of the by-pass function is the safe distinction between material and the presence of a person in front of the hazardous area. To this effect, (2 or 4) additional sensors must be connected to provide for a safe distinction between persons and the material to be transported.



To activate and parameterise the muting function, the NSR-0801 BUS converter and the SLC4 PC software is required.

Special mounting instructions for muting

All components must only be connected, wired and fitted by a specialist, who has sufficient electrical professional training and knowledge of the harmonised safety regulations.

Testing and start-up by a qualified person, who has professional knowledge as well as in particular knowledge of the harmonised legal and governmental regulations.

Instruction and training of the operators by an expert on the application.

After connection and fitting by an expert, the following instructions must be respected and observed:

- Set-up of the sensors to the operating instructions SLG 425I. The muting function must not be started by a person unintentionally accessing the hazardous area. The sensors must be set up so that a normal approach by a body part, e.g. foot, leg, hand, arm movement does not activate the muting mode.
- The selection of the operating parameters, e.g. simultaneity, muting time, operating mode, special functions, etc. must be adjusted to the application, e.g. termination of the muting cycle after passing through the protection field.
- The muting cycle must be started automatically after the command device is enabled and be controlled by at least two independent signals (sensors).
- The command device for the enabling and override function must be set up so that the operator has a clear view on the entire hazardous area. The mounting position must be selected so that the device cannot be actuated at the hazardous point.
- The muting state can be signalled through a muting lamp.



The muting function must only be used for automatic material transport to protect the accesses to the hazardous area. In this way, the material passes through the accesses and the protection field of the SLG 425I without disabling the outputs. This function is only authorised for the above-described application. For other applications, no warranty claims shall be accepted.

This document includes information for the adequate and proper by-passing of the protection field of an ESD and is reserved to persons, who have the necessary expertise and technical know-how. The users of this document must be able to adequately and correctly evaluate the risks involved in this operating mode.

This document does not provide all technical know-how, which is required in conjunction with this operating mode. To this effect, the harmonised governmental and legal provisions regarding the technical know-how must be observed.

Definitions:

Muting:	specific intended brief by-passing of the outputs of an ESD in case of automatic material transport
Muting sensor:	sensor for the uniform recognition of material
Muting lamp:	the muting lamp signals the muting state
Override:	the function enables the material transport after an exceptional stop of the muting cycle.
Belt speed:	the muting running time is stopped as long as the "belt stop" signal is active

2.9.2 Muting sensors MS

The MS muting sensor can be a mechanical, capacitive, inductive or optoelectronic sensor. They have no particular requirements as fail-safety is regarded. The set-up must be executed tamper-proof. When reflexion light barriers are used, the sensors and reflectors must be arranged alternately to avoid mutual interference. When optoelectronic sensors are used, the switching outputs must be set to dark operation (sensor actuated = 24 VDC).

The sensors must be arranged so that the transported material part is detected without any interruption over the entire length. The sensors must detect the material, not the carrier.

The distance of the sensors must not be too large, so that all activated muting sensors are actuated by the travelling material during a cycle. The simultaneity (max. 3 sec.) of the switching outputs must be observed.

A new muting process can only be started when the previous is terminated (all sensors not actuated). A safety distance of at least 50 mm (belt speed $V < 2.0$ m/s) must be observed with regard to the protection field, in order to ensure a safe signal evaluation by the control system.

Installation of the muting sensors

If 4 muting sensors are used, the switching outputs of the muting sensors MS 1 and MS 3 as well as MS 2 and MS 4 must be wired in parallel. MS 1 and MS 3 are connected to the MS1/MC female connector on the sensor connection plate. MS 2 and MS 4 to the MS 2 female connector.

Sensor connection:

with 2

muting sensors

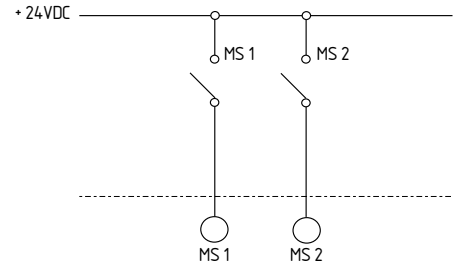

SLG 425I sensor connection

with 4

muting sensors

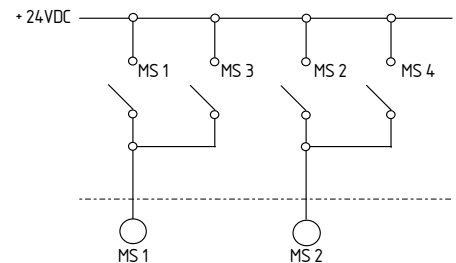

SLG 425I sensor connection



The muting sensors must be arranged so that any unintentional access or penetration of a person into the hazardous area is prevented. When positioning the muting sensors, the distance and the height must be chosen so that a clear distinction is made between material and a person!

2.9.3 Muting lamp

The operating mode "muting" can be signalled through an external muting lamp. This lamp must be connected to the sensor connection plate (ML) through a connection with a 3-pole connector socket. The muting lamp is not monitored! I.e. the electrical connection and the included illuminant are not checked by the control system of the SLG 425I.

The muting lamp signals the following operating modes:

Muting lamp	Signal	Note
ON	Continuous signal	Muting cycle active
OFF		Muting cycle not active
Flashing	2 Hz	Muting cycle error or override mode

If the muting lamps are flashing, the following failures can be present:

- Muting cycle time exceeded
- Belt stopping time exceeded
- Sequence or simultaneity of the signal conditions of the muting sensors not observed

Illuminant

For the muting lamp, a LED block with a lifetime of approx. 50 000 operating hours must be used as admissible illuminant. The utilisation of MK2 type muting lamps is recommended.

2.9.4 Signal sequence muting

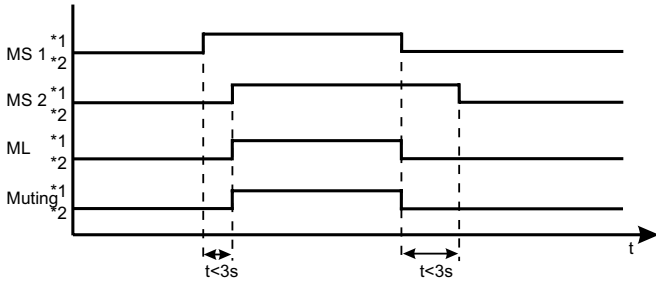

*1: active
*2: inactive

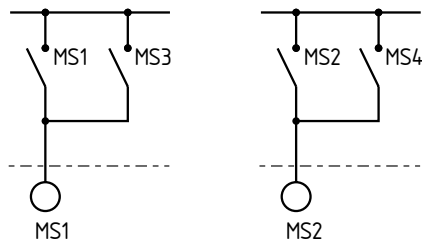

Sensor group 1 Sensor group 2

Parameter setting: muting mode with 2 sensor grupes (4 muting sensors), direction detection 1, premature termination not active

The muting function is activated after first MS 1 (first sensor group) and subsequently MS 2 (second sensor group) is actuated by the material (direction detection 1). The material first actuates the protection field of the SLG 425I, after that MS 3 (first sensor group) and finally the MS 4 (second sensor group). The muting cycle is cancelled, when MS 3 (second sensor group) is no longer actuated.

2.9.5 Configuration of the muting function

The parameters for the muting mode are set by means of the PC software: SLC 4 Kunde.exe

To this effect, the NSR-0801 BUS converter must be connected to the SLG 425I and a PC or laptop. Please use the NSR-0801 BUS converter manual for the connection.

Operating mode set-up for muting mode:

After the correct connection of the muting sensors and the NSR-0801, the following parameters must be set by means of the PC software in the "muting function" menu field in accordance with your application.

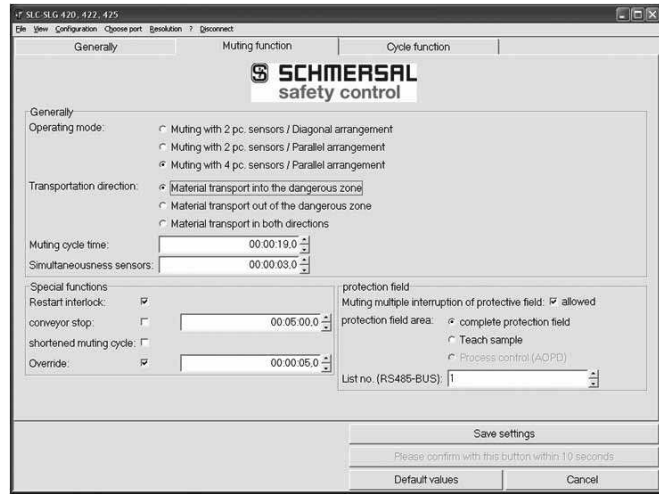

Operating mode and transport direction

First choose the operating mode and the transport direction (set-up and number of the muting sensors).

Muting with 2 sensors, diagonal arrangement

- Muting variante with 2 crosswise arranged muting sensors
- Transport direction: material transport in both directions (factory setting)
- Selectable options: belt stop, reduced muting cycle, override, protection field area

Muting with 2 sensors, parallel arrangement

- Muting variante with 2 muting sensors
- Transport direction: out of the hazardous area, reduced muting cycle (factory setting)
- Selectable options: belt stop, override, protection field area



The use of 2 parallel arranged sensors is only authorised for outward material transport, i.e. the transport of material out of the hazardous area. The muting sensors must be installed inside the hazardous area.

Muting with 4 sensors, parallel arrangement

- Muting with each time 2 symmetrically arranged sensors before and after the protection field of the SLG 425I.
- Transport direction: material transport in both directions selectable
- Selectable options: belt stop, reduced muting cycle, override, protection field area

Muting cycle time

The muting cycle time is the time expiring between the moment of activation of the muting until the inward or outward material transport in the hazardous area is completely terminated.

The muting cycle time depends on the length of the material, the belt speed and the sensor arrangement.

The time must be defined so that the material can travel by all sensors within the muting cycle time (enabling of all muting sensors). Before a new muting cycle can be initiated, all sensors must be clear (no actuation).

The muting cycle time can be set from a few seconds up to multiple hours. Longer muting cycle times can result in hazardous operating conditions. The muting cycle time must take variations in the belt speed as well as position and length tolerances of the material into consideration.

Reduced muting cycle

A normal muting cycle is terminated by a muting sensor in the following way:

- Muting with 2 sensors, diagonal arrangement after enabling of muting sensor MS 2
- Muting with 4 sensors, parallel arrangement after enabling of muting sensor MS 3

For very long muting cycle times, this results in a time window with bridged protection field, as long as the material is located between the protection field and the muting sensor MS 2/MS 3.

By activating the function "reduced muting time", the muting cycle is shortened/reduced. The muting cycle is terminated, when the material has travelled by the protection field of the SLG 425I (protection field clear).

This field is always activated when applied with 2 parallel arranged muting sensors. For applications with 2 diagonally arranged MS or 4 parallel arranged MS, the function can be activated by means of the software.

A new muting cycle can only be started, when all muting sensors are no longer actuated.

Simultaneity of the sensors

The timeframe between the first and the second muting sensor is monitored. In this way, a uniformly-shaped transport good can be distinguished from other switching times (passing by of a person) in case of an adequate arrangement of the muting sensors.

The simultaneity setting must take variations in the belt speed, as well as the position and length tolerances of the material into consideration.

The simultaneity of the sensors can be set between 1 to 3 seconds.

Setting the special functions is recommended. In this way, the protective function and the availability of the muting application is increased.

Restart interlock (manual reset)

The restart interlock (manual reset) prevents an automatic belt start after voltage interruption or material jamming.

The restart interlock (manual reset) must be wired as shown in the wiring diagram (chapter 4). The function is active upon delivery.

The command device must be installed outside of the hazardous area, so that the operator has a clear view on the area.

The command device must be actuated after any interruption of the voltage or the protection field or fault of the muting cycle. Enabling is only possible, when all muting sensors are not actuated. The signalling for the actuation of the command device is realised by a status LED on the receiver.

The function can be deactivated by removing the check mark in the software. By doing this the following operating condition is created: the outputs OSSD's are released, when all light beams and the muting sensors are not interrupted (light path clear). The same applies after an interruption of the voltage supply. A release through the command device is only required after a malfunction (muting cycle fault). The owner then must secure this function through the application.



The deactivation of the "restart interlock (manual reset)" function can trigger an automatic muting cycle. In this way, persons can access/penetrate into the hazardous area. Persons within the hazardous area are exposed to severe injuries.

Belt stop

The function can extend the muting cycle time in case of a belt stop or material jamming, thus preventing a premature shutdown. In this way, the muting function can be extended until the failure/belt stop is rectified. After that, the normal muting cycle can be completed.

The machine control makes the belt stop input available as signal. The function is activated by switching on 24 VDC at pin 8 of the receiver. A status change of the muting sensors (switching output) when the function is active, causes the muting function to be switched off.

The function is deactivated upon delivery. The belt stop time can be set from 1 to 30 minutes.

Override

This function enables bridging the outputs of the SLG 425I in case of failure (voltage interruption, material jamming). The function is limited in time and exclusively reserved to the elimination of the material jamming (muting sensor or protection field actuated).

The function is activated by means of the command device (restart interlock enabling). The command device must be actuated in the sequence ON-OFF-ON. The time-related sequence for the start (ON-OFF-ON) with a minimum duration of 100 ms up to the maximum duration of 1.5 sec. must be observed. If the material jamming is eliminated (protection field and muting sensors no longer actuated), the outputs of the SLG 425I are locked. To start a new muting cycle, the command device (enabling of the restart interlock) must be actuated one time (ON-OFF). The muting lamp starts flashing (2 Hz) to signal the interruption of the muting cycle. The function is not activated upon delivery.

Multiple interruption of the protection field during the muting cycle

This function increases the availability of the system in case of different material qualities on one pallet.

Without the function "multiple interruption of the protection field", the protection field is monitored during the active muting cycle and any non-actuation (no beam interrupted) immediately cancels the muting cycle. This error function is triggered when all active beams of the protection field are not actuated for a period of time of over 20 ms e.g. due to an irregular loading of the material on the carrier. If the function is activated, no shutdown is triggered if the beams are not actuated during the muting cycle. The correct termination is realised by the configuration or the muting sensors. The combination with the parameter setting "reduced muting cycle" is not possible. These restrictions are marked in the software and must be observed.

Activating the protection field

During a muting cycle, the entire protection field height of the SLG 425I is bridged. This causes the risk that persons located on or beside the material can get into the hazardous area.

The risk can be avoided by activating the remainder of the protection field, if the conveyed material has a throughout identical height. In this way, the presence of persons within the active protection field height is detected!

Procedure:

Position the material onto the carrier so that the protection field of the SLG 425I is actuated. If the material height is slightly varying, the carrier can be slightly increased during the teaching process to avoid false triggering. Now activate the teach sample field in the software. The menu automatically switches to the beam view. The beams interrupted by the material are represented in red. The teaching process is terminated with a mouse click on the "teach" field. You will return to the main menu "muting".

Changing the protection field area

If the protection field height parameterised by means of the teach process needs to be changed, the saved value must be deleted and reparameterised.

Procedure:

Activating the entire protection field (the previous value is deleted)
 Activating the teach sample (change to beam view)
 Saving the new value (teach process) with teach



Mounting:

The first light beam (near the diagnostic window) must not be interrupted! I.e. observe the downward cable connection.

2.9.6 Saving the data

After the reconfiguration, the data to be saved are prepared by selecting the button "Save settings". To avoid any unintentional saving of data, every intentional saving process must be confirmed within 10 seconds by clicking on the button "Confirm with this button within 10 seconds".

If it is not confirmed within this timeframe, the settings that were saved before the change was made will be maintained without any change.

After the data transmission, the following confirmation is displayed. You are simultaneously asked to save the configuration data in the form of a text file.



This saving procedure is recommended so that configuration changes can be reproduced at a later moment. Click the (yes) button with your mouse to confirm.

You now can save the configuration setting onto your PC or laptop.

2.9.7 Muting applications

Arrangement of the muting sensors

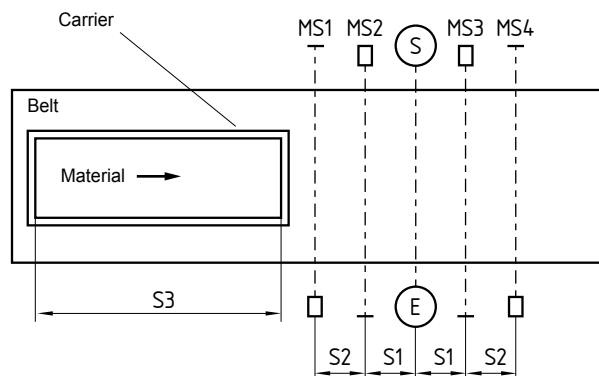
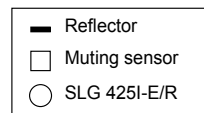
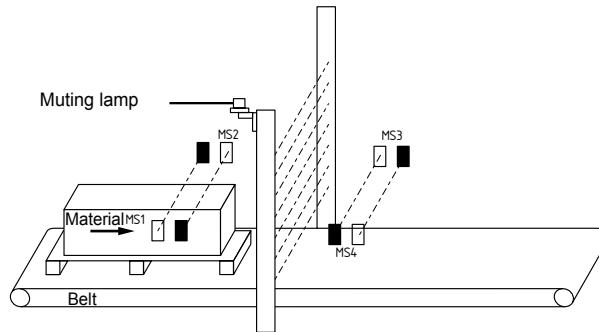

- SF = Protection field
- S1 = distance of the inner MS to SF
- S2 = distance between two MS
- S3 = material length
- MS 1 = Muting sensor 1
- MS 2 = Muting sensor 2
- MS 3 = Muting sensor 3
- MS 4 = Muting sensor 4
- S = Transmitter
- E = Receiver

Minimum distances muting sensors

For the evaluation of the signals (MS) in the control system, a minimum distance is required for the muting sensors.

The minimum signal length between the sensors, which are fitted closest to the SLG 425I, must be at least 50 ms. This corresponds to a minimum distance of 100 mm at a belt speed of 2.0 m/s.

The minimum signal length of the outer sensors must exceed 50 ms. The signal running time between the muting sensors must be 3 seconds at the most (depending on the chosen setting).

The mounting distance of the inner sensors to the protection field of the SLG 425I must be chosen as small as possible.

The sensors (transmitter/receiver) of the SLG 425I must be fixed as close as possible to the conveyed material to avoid the creation of gaps. Otherwise, there is a risk that persons can slip between the material and the MS arrangement into the hazardous area during the muting cycle.

In case of different material widths, the gap between the sensors (transmitter/receiver) of the SLG 425I and the material must be protected with an additional cover.

Muting with 2 sensors, parallel arrangement

The arrangement shows the muting application with two parallel arranged muting sensors. This arrangement enables the material to be transported in only one direction, out of the hazardous area.

Schematic representation

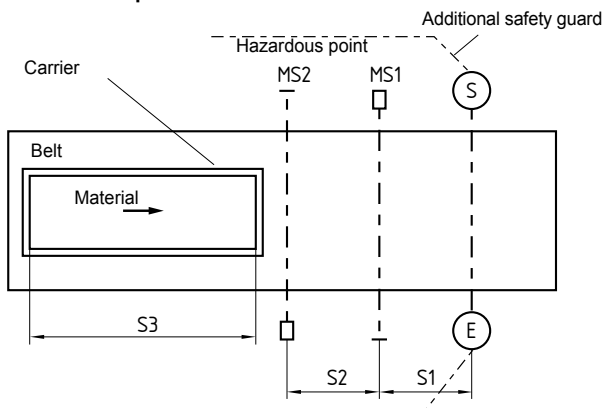

- S1 = distance MS 1 to SF
- S2 = distance MS 1 to MS 2
- S3 = material length
- MS 1 = Muting sensor 1
- MS 2 = Muting sensor 2
- S = Transmitter
- E = Receiver
- VB = belt speed (m/s)
- SF = Protection field

$$S3 > S1 + S2$$

$$S1 = \text{belt speed } VB \text{ (m/s)} \times 0,05 \text{ s}$$

The muting cycle is as follows: **MS2 - MS1 - SF - end**

Selectable options: belt stop, override, protection field area

Factory setting: reduced muting cycle, i.e. the muting cycle is terminated when the protection field is released.



This arrangement is only authorised when the muting sensors are installed inside the hazardous area.

Muting with 2 sensors, diagonal arrangement

The arrangement shows the muting application with two diagonally (crosswise) arranged muting sensors. This arrangement enables the material to be transported in both directions.

Schematic representation

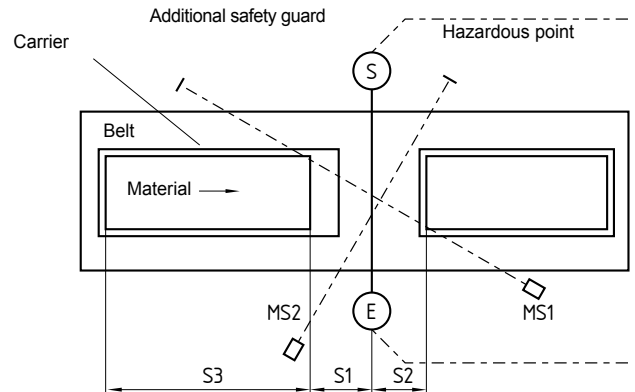

- S1 = distance MS 1 to SF
- S2 = distance MS 2 to SF
- S3 = material length
- MS 1 = Muting sensor 1
- MS 2 = Muting sensor 2
- S = Transmitter
- E = Receiver
- VB = belt speed (m/s)
- SF = Protection field



The intersection of the muting sensors must always be within the hazardous area!

$$S3 > S1 + S2$$

$$S1 = \text{belt speed } VB \text{ (m/s)} \times 0,05 \text{ s}$$

In the schematic diagram, the arrangement of the muting sensors is represented with a larger distance to enable a uniform identification of the sensor sequence. Please observe the smallest possible distance of the MS to the transported material. The distance of MS 1 and MS 2 to the protection field of the SLG 425I must be chosen as small as possible as well.

The muting cycle is as follows: **MS1 - MS2 - SF - MS2 - end**

Selectable options: belt stop, reduced muting cycle, override, protection field area

Factory setting: material transport in both directions

The muting sensors must be arranged so that a uniform sequence of the muting sensors is ensured.

Muting with 4 sensors, parallel arrangement

The arrangement shows the muting application with four parallel arranged muting sensors. This arrangement enables the material to be transported in both directions.

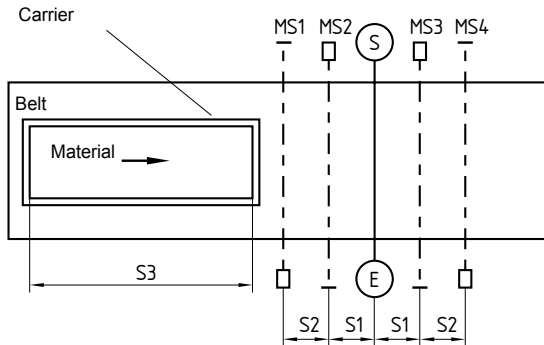

- S1 = distance of the inner MS to SF
- S2 = distance between two MS
- S3 = material length
- MS 1 = Muting sensor 1
- MS 2 = Muting sensor 2
- MS 3 = Muting sensor 3
- MS 4 = Muting sensor 4
- S = Transmitter
- E = Receiver
- VB = belt speed (m/s)
- SF = Protection field

$$S3 > 2(S1 + S2)$$

$$S1 = \text{belt speed VB (m/s)} \times 0,05 \text{ s}$$

The muting cycle is as follows: **MS1 - MS2 - SF - MS3 end**
MS4 - MS3 - SF - MS2 end

Selectable options: belt stop, reduced muting cycle, override, protection field area

Factory setting: material transport in both directions

The muting figure with each time 2 muting sensors shows a symmetrical arrangement before and after the protection field of the SLG 425I.

3. Mounting

3.1 General conditions

The following guidelines are provided as preventive warning notices to ensure a safe and appropriate handling. These guidelines are an essential part of the safety instructions and therefore must always be observed and respected.



- The SLG must not be used on machines, which can be stopped electrically in case of emergency.
- The safety distance between the SLG and a hazardous machine movement must always be observed and respected.
- Additional mechanical safety guards must be installed so that the operator has to pass by the protection field to reach the hazardous machine parts.
- The SLG must be installed so that the personnel always must be within the detection zone when operating the machine. An incorrect installation can lead to serious injuries.
- Never connect the outputs to +24VDC. If the outputs are wired to +24VDC, they are in ON state, as a result of which they are unable to stop a hazardous situation occurring on the application/machine.
- The safety inspections must be conducted regularly.
- The SLG must not be exposed to inflammable or explosive gasses.
- The connecting cables must be connected in accordance with the installation instructions.
- The fixing screws of the end caps and the mounting angle must be firmly tightened.
- Additional measures could be required to ensure that the electro-sensitive device does not present a dangerous breakdown, when other forms of light beams are available in a special application (e.g. use of wireless control devices on cranes, radiation of welding sparks or effects of stroboscopic lights).

3.2 Protection field and approach

The protection field consists only of the available individual beams with a distance of 300, 400 or 500 mm. Additional protective devices must ensure that hazardous machine movements can only be reached after passing through the protection field.

The SLG must be installed so that the hazardous area is completely protected, if necessary by means of additional safety guards.

The safety distance before the hazardous point to the SLG safety guard must be imperatively respected. The safety distance enables the presence of persons within the hazardous area. Therefore, it must be ensured that the hazardous movement can only take place, when no persons are inside the hazardous area anymore. The legal and governmental provisions must be observed for the operation and use. These provisions are usually region- and country-dependent.



The command devices (enabling button) must be installed outside of the hazardous area so that any operation from within the hazardous area is prevented. The operator must have a clear view on the hazardous area, when actuating the command device (enabling button).

3.3 Alignment

Procedure:

1. The transmitter and the receiver must be fitted parallel to each other and at the same height.
2. Turn the transmitter and monitor the diagnostic window of the receiver. Fix the light grid, when the LED OSSD ON (green) is on and the LED signal reception (orange) is off.
3. Determine the max. rotating angle to the left and to the right, at which the LED OSSD ON (green) is on and tighten the mounting screws in central position. Make sure that the LED signal reception (orange) is not on or flashing.

3.4 Safety distance

The safety distance is the minimum distance between the SLG 425I and the hazardous point, which must be observed in order to ensure that the hazardous point can only be reached after the hazardous movement has come to standstill.



The protection using individual beams must be chosen so that bodies or body parts larger than the selected resolution (beam distance + beam diameter 10 mm) of the SLG 425I are detected.

Calculation of the safety distance to EN ISO 13855 and EN ISO 13857

The safety distance depends on the following elements:

- Run-on time of the machine (calculation by run-on time measurement)
- Response time of the machine and the safety light grid and the downstream relay (entire safety guard)
- Approach speed
- Resolution of the safety light grid

Calculation of the safety distance for the safety light grid:

$$S = (K \cdot 1600 \text{ mm/s} \times T) + C$$

S = Safety distance [mm]

T = Run-on time of the machine + reaction time of the safety light grid

K = Approach speed 1600 mm/s

C = Safety supplement 850 mm

Example:

Reaction time of the SLG 425I = 10 ms

Run-on time of the machine T = 170 ms

$$S = 1600 \text{ mm/s} \cdot (170 \text{ ms} + 10 \text{ ms}) + 850 \text{ mm}$$

$$S = 1138 \text{ mm}$$

The following mounting heights must be observed:

Number of beams	Mounting height above reference floor in mm
2	400, 900
3	300, 700, 1100
4	300, 600, 900, 1200



The safety distance between the safety light grid and the hazardous point must always be respected and observed. If a person reaches the hazardous point before the hazardous movement has come to standstill, he/she is exposed to serious injuries.

Safety distance to the hazardous area

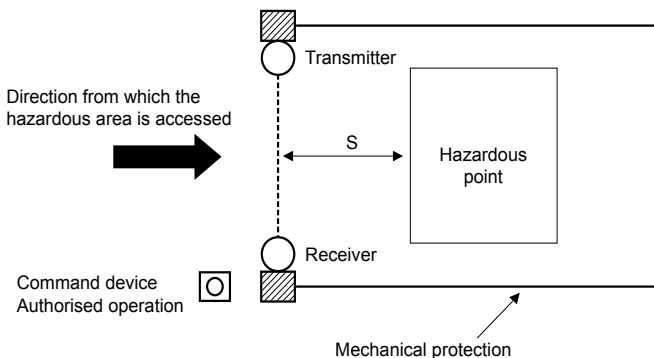

The formulae and calculation examples are related to the vertical set-up (refer to drawing) of the safety light grid with regard to the hazardous point. Please observe the applicable harmonised EN standards and possible applicable national regulations.



To calculate the minimum distances of the safety guards with regard to the hazardous point, the EN ISO 13855 and EN ISO 13857 must be observed.

If an overlap of the protection field is possible, take care to the calculation of the safety distance referring to additional CRO according to the table A1 as per norm EN ISO 13855.

3.4.1 Minimum distance to reflecting surfaces

During the installation, the effects of reflecting surfaces must be taken into account. In case of an incorrect installation, interruptions of the protection field could possibly not be detected, which could lead to serious injuries. The hereafter-specified minimum distances with regard to reflecting surfaces (metal walls, floors, ceilings or parts) must be imperatively observed.

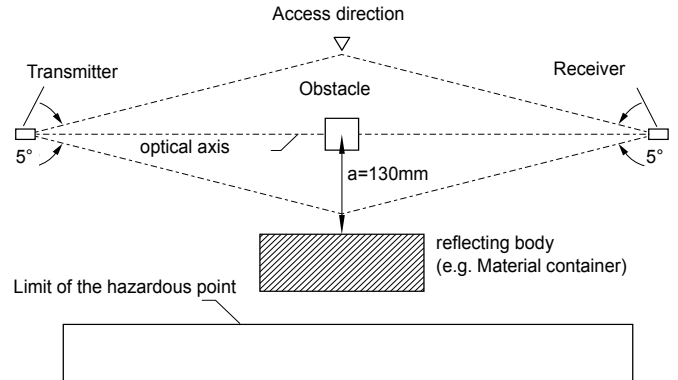
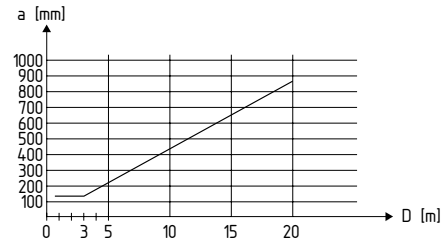

Table: Safety distance to reflecting surfaces a depending on the aperture angle



Calculate the minimum distance to reflecting surfaces as a function of the distance with an aperture angles of $\pm 2.5^\circ$ degrees or use the value from the table below:

Distance [m] between transmitter and receiver	Minimum distance a [mm]
0.2 ... 3.0	130
4	175
5	220
7	310
10	440
15	660

$$\text{Formula: } a = \tan 2.5^\circ \times L \text{ [mm]}$$

a = Minimum distance to reflecting surfaces

L = Distance between transmitter and receiver

3.5 Dimensions

All measurements in mm.

SLG425I-ER-0500-02-RF (2-beam version)							
A	B		C		L2		L1
	Trans-mitter	Re-ceiver	Trans-mitter	Re-ceiver	Trans-mitter	Re-ceiver	
500	648	712	684	748	303	239	349

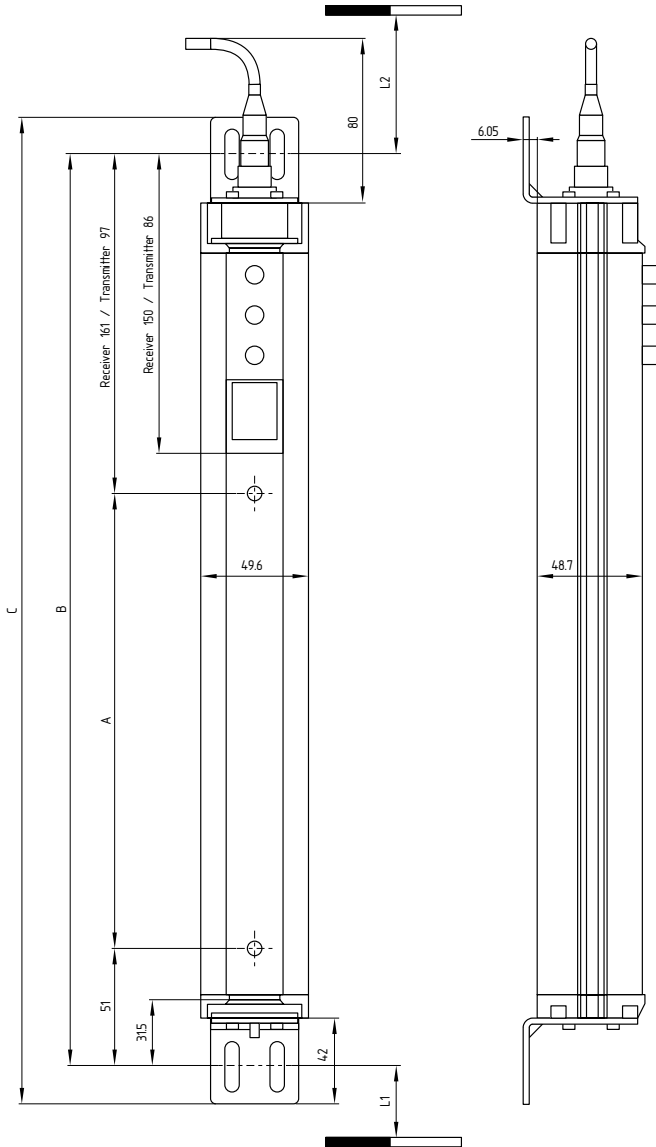

Legend

- A = Beam distance
 - B = Mounting dimension
 - C = Total length
 - L1 = Mounting distance (mm) between floor and slotted hole centre (short end cap)
 - L2 = Mounting distance (mm) between floor and slotted hole centre (diagnostic window)
- *All measurements ± 1 mm

SLG425I-ER-0800-03-RF (3-beam version)							
A	B		C		L2		L1
	Trans-mitter	Re-ceiver	Trans-mitter	Re-ceiver	Trans-mitter	Re-ceiver	
400	948	1012	948	1048	203	139	249

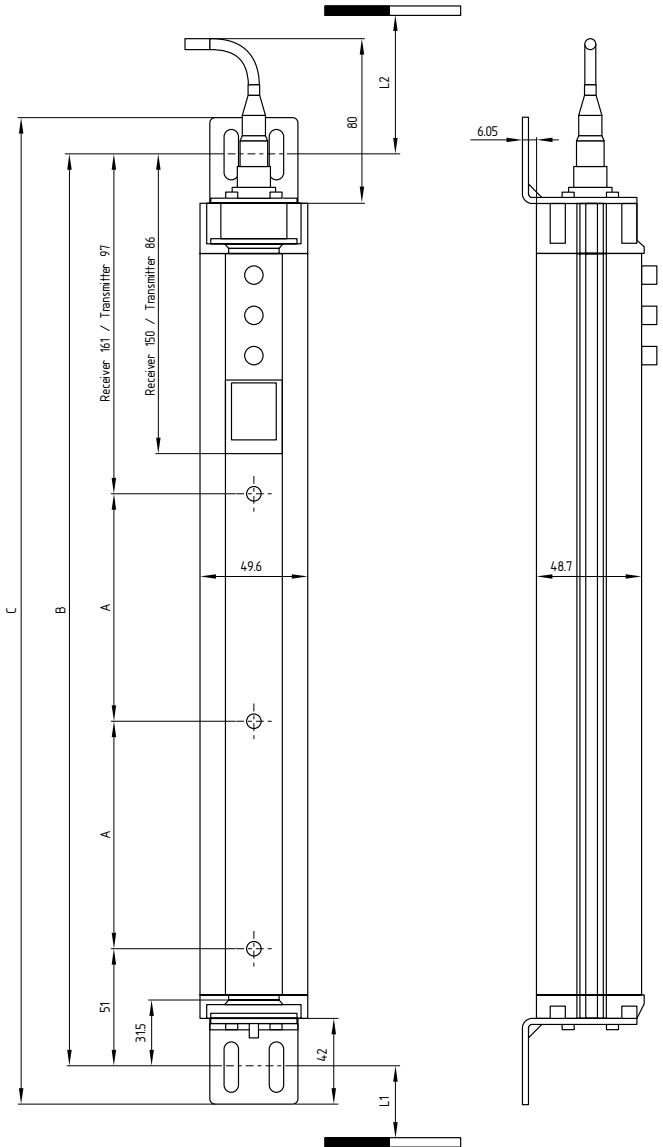

Legend

- A = Beam distance
 - B = Mounting dimension
 - C = Total length
 - L1 = Mounting distance (mm) between floor and slotted hole centre (short end cap)
 - L2 = Mounting distance (mm) between floor and slotted hole centre (diagnostic window)
- *All measurements ± 1 mm

SLG425I-ER-0900-04-RF (4-beam version)							
A	B	C	L2	L1			
Trans-mitter	Re-ceiver	Trans-mitter	Re-ceiver	Trans-mitter	Re-ceiver		
300	1088	1152	1124	1188	203	139	209

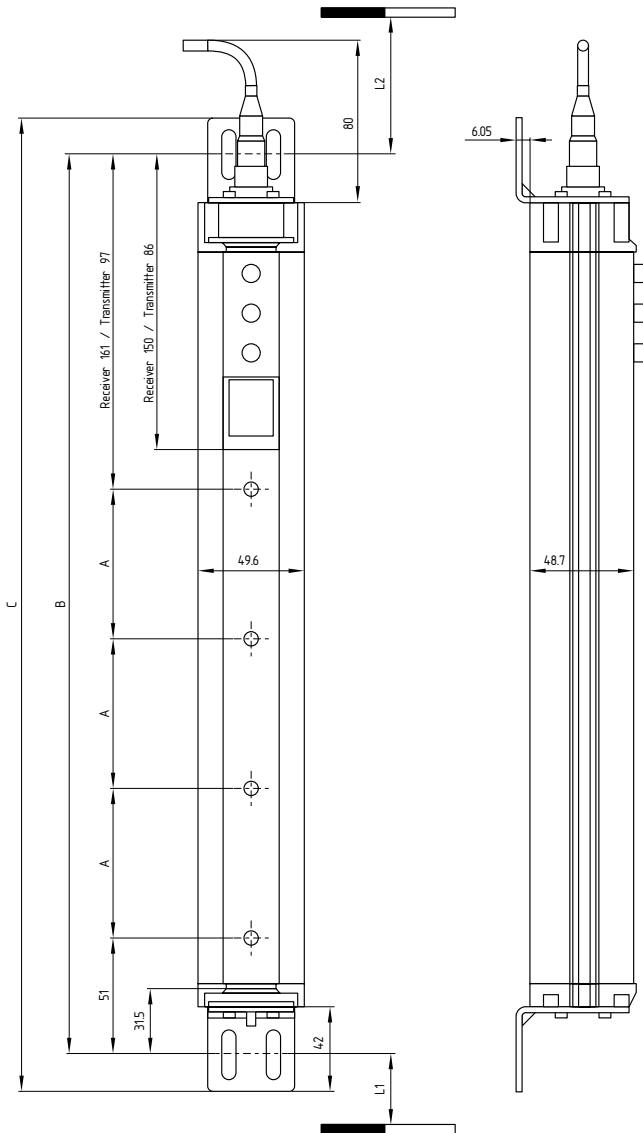

Legend

- A = Beam distance
- B = Mounting dimension
- C = Total length
- L1 = Mounting distance (mm) between floor and slotted hole centre (short end cap)
- L2 = Mounting distance (mm) between floor and slotted hole centre (diagnostic window)
- *All measurements ± 1 mm

Accessories

Fixing kit MS-1030

The fixing kit consists of 4 steel angles and 16 fixing screws.

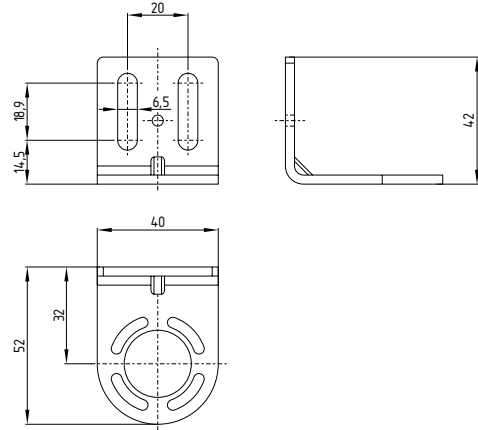

Centre fixing MS-1051 (optional accessory)

Mounting kit consists of 2 steel angles, 4 screws and 4 T-slot nuts for central fixing

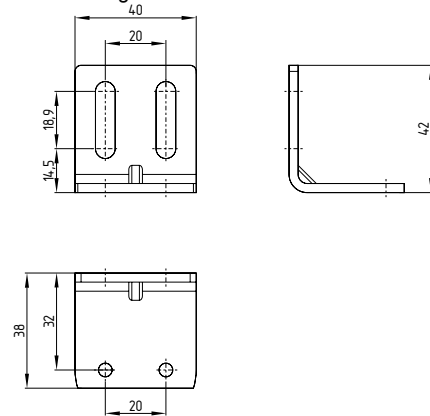

4. Electrical connection

4.1 Wiring example Muting

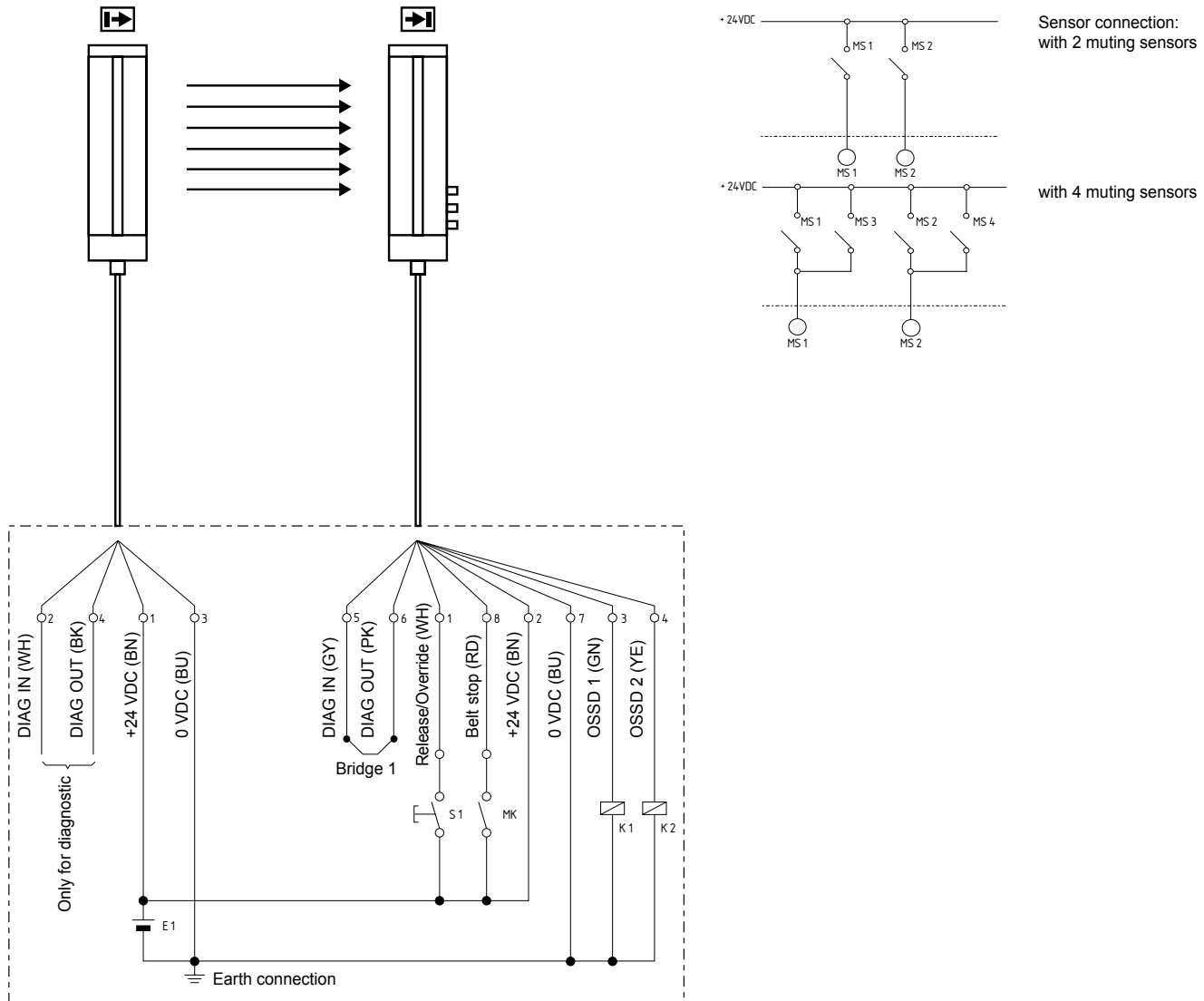

Bridge 1: Restart interlock (manual reset) active (bridge between DIAG OUT and DIAG IN)

Legend

- K1, K2: Relay for processing the switching outputs OSSD 1, OSSD 2
- MK: Machine contact belt stop (optional)
- S1: Command device button for enabling restart/override
- E1: Power supply 24 VDC ± 10%

4.2 Connector configuration Receiver, Emitter & Cable

RECEIVER	Signal	Designation	Description
SLG: connector			
M12 / 8 pole male			
	1 WH	Release/Override	Input
	2 BN	24 VDC	Power supply
	3 GN	OSSD 1	Safety output 1
	4 YE	OSSD 2	Safety output 2
	5 GY	Diagnostic IN	Input diagnostic data
	6 PK	Diagnostic OUT	Output diagnostic data
	7 BU	0 VDC	Power supply
	8 RD	Belt stop	Input

Cable: Connector
M12 / 8 pole female

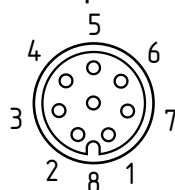

TRANSMITTER		Signal	
SLG: connector	Designation	Description	
M12 / 4 pole male			
	1 BN	24 VDC	Power supply
	2 WH	Diagnostic IN	Input diagnostic data
	3 BU	0 VDC	Power supply
	4 BK	Diagnostic OUT	Output diagnostic data

Cable: Connector
M12 / 4 pole female

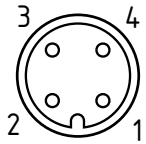

The colour codes are only valid for the cable types mentioned below "optional accessories".

Sensor connection field

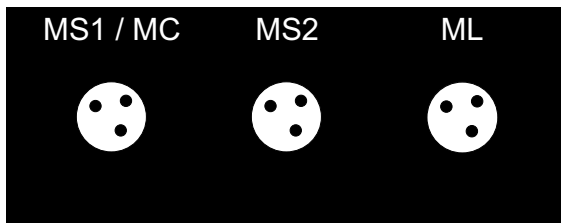

MS1/MC = Muting sensor 1/machine contact MC
MS 2 = muting sensor 2
ML = Muting lamp

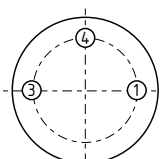
Muting sensors	PIN No.	Signal	Description
	1	+24 VDC	Power supply
	3	0 V	Power supply
	4	+24 VDC	Switching output sensor

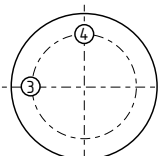
Muting lamp	PIN No.	Signal	Description
	3	0 V	Power supply
	4	+24 VDC	Switching output muting lamp

5. Set-up and maintenance

5.1 Check before start-up

Prior to start-up, the following items must be checked by the responsible person.

Wiring check prior to start-up

- The voltage supply is a 24V direct current power supply, which meets the CE Directives, Low Voltage Directives. A power downtime of 20 ms must be bridged.
- Presence of a voltage supply with correct polarity at the SLG.
- The connecting cable of the transmitter is correctly connected to the transmitter and the connecting cable of the receiver correctly to the receiver.

- The double insulation between the light grid output and an external potential is guaranteed.
- The outputs OSSD1 and OSSD2 are not connected to +24 VDC.
- The connected switching elements (load) are not connected to +24 VDC.
- If two or more SLG are used within close range compared to each other, an alternating arrangement must be observed. Any mutual interference of the systems must be prevented.

Switch the SLG on and check the operation in the following way:
The component performs a system test during approx. 2 seconds after the operating voltage has been switched on. After that, the outputs are enabled (if the protection field is not interrupted). The LED "OSSD ON" of the receiver is on.



In case of incorrect functioning, please follow the instructions listed in the chapter Fault diagnostic.

5.2 Maintenance



Do not use the SLG before the next inspection is terminated. An incorrect inspection can lead to serious and mortal injuries.

Conditions

For safety reasons, all inspection results must be archived. The operating principle of the SLG and the machine must be known in order to be able conducting an inspection. If the fitter, the planning technician and the operator are different persons, please make sure that the user has the necessary information at his disposal to be able conducting the maintenance.

5.3 Regular check

A regular visual inspection and functional test, including the following steps, is recommended:

- The component does not have any visible damages.
- The optics cover is not scratched or soiled.
- Hazardous machinery parts can only be accessed by passing through the protection field of the SLG.
- The staff remains within the detection area, when works are conducted on hazardous machinery parts.
- The safety distance of the application exceed the mathematically calculated one.

Operate the machine and check whether the hazardous movement stops under the hereafter-mentioned circumstances.

- Hazardous machine parts do not move when the protection field is interrupted.
- The hazardous machine movement is immediately stopped, when the protection field is interrupted with the test rod immediately before the transmitter, immediately before the receiver and in the middle between the transmitter and the receiver.
- No hazardous machine movement when the test rod is within the protection field.
- The hazardous machine movement comes to standstill, when the voltage supply of the SLG 425I is switched off.

5.4 Half-yearly inspection

The following items must be checked every six months or when a machine setting is changed.

- Machine stops or does not inhibit any safety function.
- No machine modification or connection change, which affects the safety system, has taken place.
- The outputs of the SLG are correctly connected to the machine.
- The total response time of the machine does not exceed the response time calculated during the first putting into operation.
- The cables, the connectors, the caps and the mounting angles are in perfect condition.

5.5 Cleaning

If the optics cover of the sensors is extremely soiled, the OSSD outputs can be disabled. Clean with a soft cloth without exercising pressure. The use of aggressive, abrasive or scratching cleaning agents, which could attack the surface, is prohibited.

6. Diagnostic

6.1 LED status information

Receiver	Function	LED colour	Description
	Multifunction	green	Function display, beam coding
	Blanking	blue	Protection field(s) inactive (blinking)
	Signal reception	orange	Evaluation of the signal reception
	Restart	yellow	Input for command device
	OSSD OFF	red	Safety outputs signal condition OFF
	OSSD ON	green	Safety outputs signal condition ON

Transmitter	Function	LED colour	Description
	Transmitting	orange	Transmitter active
	Status	green	Function display, beam coding

Receiver	Status LED	Description
LED	ON	Protection field clear
OSSD ON	Flashing	Diagnostic mode active
OSSD OFF	ON	Protection field interrupted, system or configuration error
	Flashing	Diagnostic mode active, error output refer to Fault diagnostic table
Restart	ON	Start or restart interlock (manual reset) active, signal expected at output WA
Signal reception	ON/flashing	Signal reception too low, check alignment and installation height between transmitter and receiver
		Cleaning the black profile cover
	OFF	Alignment between transmitter and receiver OK
Blanking	1 flashes	Fixed blanking of the protection field(s)
Multifunction	1 flashes	Muting (complete protection field)
	2 flashes	Muting (only teached protection field)
	3 flashes	Muting through BUS control
	4 flashes	reserved
	5 flashes	Beam coding A is active

Transmitter	Status LED	Description
LED	ON	Standard operation, transmitter active
Transmitting	Flashing	Configuration error
Status	Flashing	Beam coding A is active

6.2 Fault diagnostic

The light grid performs an internal self-test after the operating voltage is switched on and the protection field is enabled. When a fault is detected, a corresponding flashing pattern is emitted at the receiver through the LED OSSD OFF (red). Every fault emission is followed by a one-second pause.

LED OSSD OFF	Fault feature	Action
OSSD OFF and LED restart continuous flashing	Wiring error for function selection (Restart interlock (manual reset), automatic mode)	Check connection at the receiver, bridge 1 or bridge 2 must be wired (refer to Wiring)
1 flashes	Error at sensor receiver	Replace receiver
2 flashes	Error contactor control OFF	Check connections at contactor control input, refer to Wiring, check wiring of the auxiliary contacts
3 flashes	Error contactor control ON	Check wiring at contactor control input, short-circuit at +UB and mass. Power reset after fault rectification.
4 flashes	Errors at the OSSD outputs	Check the wiring of the outputs, OSSD for short-circuit at +UB and mass
5 flashes	Error configuration data	Check the configuration settings by means of the NSR-0801 BUS converter
6 flashes	Error blanking	The receiver has detected blanked beams as beams without interruption, i.e. locking. Check the configuration settings by means of the NSR-0801 BUS converter, repeat the teach process with blanking.

6.3 Extended diagnostic

By means of the optional configuration software and the NSR-0801 BUS converter, an extended diagnostic can be executed. The software provides the status information of the component and can represent the individual light lines. This feature enables an optimal adjustment of the light grid. The diagnostic mode is signalled by the OSSD ON and OSSD OFF LED's at the receiver. In diagnostic mode, protective mode is disabled, the ODDS outputs being locked. The change from diagnostic mode to protective mode is automatically realised after Power Reset, when the BUS converter is no longer integrated and the connecting cable of the sensor is reconnected.

7. Disassembly and disposal

7.1 Disassembly

The safety switchgear must be disassembled in a de-energised condition only.

7.2 Disposal

The safety switchgear must be disposed of in an appropriate manner in accordance with the national prescriptions and legislations.

8. Appendix

8.1 Contact

Consultancy / Sales:



K.A. Schmersal GmbH
 Industrielle Sicherheitsschaltssysteme
 Möddinghofe 30
 D-42279 Wuppertal
 Tel:+49 (0) 202 64 74 -0
 Fax:+49 (0) 202 64 74- 100

You will also find detailed information regarding our product variety on our website: www.schmersal.com

Repair handling / shipping:

Safety Control GmbH
 Am Industriepark 11
 D-84453 Mühldorf / Inn
 Tel.: +49 (0) 8631-18796-0
 Fax: +49 (0) 8631-18796-1

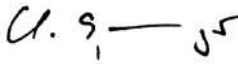
8.2 EC Declaration of conformity

		
<h2>EC Declaration of conformity</h2>		
Translation of the original declaration of conformity	Safety Control GmbH Am Industriepark 33 84453 Mühldorf / Inn Germany Internet: www.schmersal.com	
<p>We hereby certify that the hereafter described safety components both in its basic design and construction conform to the applicable European Directives.</p>		
Name of the safety component / type:	SLG 425I	
Description of the safety component:	Safety light grid	
Harmonised EC-Directives:	2006/42/EC - EC-Machinery Directive 2004/108/EC - EMC-Directive	
Applied standards:	EN 61496-1:2004 + A1 2008 CLC/TS 61496-2:2006 EN ISO 13849-1:2008; PL e EN 62061:2005; SIL 3	
Person authorized for the compilation of the technical documentation:	Ulrich Loss Möddinghofe 30 42279 Wuppertal	
Notified body for the prototype test:	TÜV Nord Cert GmbH Langemarckstr.20 45141 Essen ID n°: 0044	
EC- test certificate:	n° 44 205 10 555867 005	
Place and date of issue:	Mühldorf, February 1, 2010	
SLG 425I-B-EN	 Authorized signature Christian Spranger Managing Director	 Authorized signature Klaus Schuster Managing Director



The currently valid declaration of conformity can be downloaded from the internet at www.schmersal.net.



Safety Control GmbH
Am Industriepark 33
D-84453 Mühldorf / Inn

Telefon +49 - (0)86 31 - 187 - 9 60
Telefax +49 - (0)86 31 - 187 - 9 61
E-Mail: info@safetycontrol.com