



EN Operating instructions. pages 1 to 10
Translation of the original operating instructions

Content

1 About this document

1.1 Function 1

1.2 Target group: authorised qualified personnel. 1

1.3 Explanation of the symbols used 1

1.4 Appropriate use 1

1.5 General safety instructions 1

1.6 Warning about misuse 2

1.7 Exclusion of liability 2

2 Product description

2.1 Ordering code 2

2.2 Special versions. 2

2.3 Comprehensive quality insurance to 2006/42/EC 2

2.4 Destination and use 2

2.5 Technical data 3

2.6 Safety classification 3

3 Mounting

3.1 General mounting instructions 3

3.2 Dimensions 4

3.3 Actuating positions of the safety sensor with regard to the actuator 4

3.4 Switching distance 4

3.5 Adjustment 5

4 Electrical connection

4.1 General information for electrical connection. 5

4.2 Series-wiring 5

5 Set-up and maintenance

5.1 Functional testing. 5

5.2 Maintenance 5

6 Diagnostic functions

6.1 Operating principle of the diagnostic LED's 6

6.2 Operating principle of the electronic diagnostic output 6

6.3 Safety-sensors with serial diagnostic function 7

7 Disassembly and disposal

7.1 Disassembly. 7

7.2 Disposal 7

8 Appendix

8.1 Wiring examples 8

8.2 Connection example 9

9 Declaration of conformity

9.1 EC Declaration of conformity 10

1. About this document

1.1 Function

This operating instructions manual provides all the information you need for the mounting, set-up and commissioning to ensure the safe operation and disassembly of the safety switchgear. The operating instructions must be available in a legible condition and a complete version in the vicinity of the device.

1.2 Target group: authorised qualified personnel

All operations described in this operating instructions manual must be carried out by trained specialist personnel, authorised by the plant operator only.

Please make sure that you have read and understood these operating instructions and that you know all applicable legislations regarding occupational safety and accident prevention prior to installation and putting the component into operation.

The machine builder must carefully select the harmonised standards to be complied with as well as other technical specifications for the selection, mounting and integration of the components.

1.3 Explanation of the symbols used



Information, hint, note:

This symbol is used for identifying useful additional information.



Caution: Failure to comply with this warning notice could lead to failures or malfunctions.

Warning: Failure to comply with this warning notice could lead to physical injury and/or damage to the machine.

1.4 Appropriate use

The products described in these operating instructions are developed to execute safety-related functions as part of an entire plant or machine. It is the responsibility of the manufacturer of a machine or plant to ensure the correct functionality of the entire machinery or plant.

The safety switchgear must be exclusively used in accordance with the versions listed below or for the applications authorised by the manufacturer. Detailed information regarding the range of applications can be found in the chapter "Product description".

1.5 General safety instructions

The user must observe the safety instructions in this operating instructions manual, the country-specific installation standards as well as all prevailing safety regulations and accident prevention rules.



Further technical information can be found in the Schmersal catalogues or in the online catalogue on the Internet: www.schmersal.net.

The information contained in this operating instructions manual is provided without liability and is subject to technical modifications.

There are no residual risks, provided that the safety instructions as well as the instructions regarding mounting, commissioning, operation and maintenance are observed.

1.6 Warning about misuse



In case of improper use or manipulation of the safety switch-gear, personal hazards or damages to machinery or plant components cannot be excluded when safety switchgear is used. The relevant requirements of the standard ISO 14119 must be observed.

1.7 Exclusion of liability

We shall accept no liability for damages and malfunctions resulting from defective mounting or failure to comply with this operating instructions manual. The manufacturer shall accept no liability for damages resulting from the use of unauthorised spare parts or accessories.

For safety reasons, invasive work on the device as well as arbitrary repairs, conversions and modifications to the device are strictly forbidden; the manufacturer shall accept no liability for damages resulting from such invasive work, arbitrary repairs, conversions and/or modifications to the device.

2. Product description

2.1 Ordering code

This operating instructions manual applies to the following types:

CSS-①-34②-③-M-④

No.	Option	Description
①	12	Actuation from top
	14	Actuation from side
②	S	lateral active surface
	V	frontal active surface
③	D	With diagnostic output
	SD	with serial diagnostic function
④	L	with connecting cable
	ST	with integrated connector



Only if the information described in this operating instructions manual are realised correctly, the safety function and therefore the compliance with the Machinery Directive is maintained.

2.2 Special versions

For special versions, which are not listed in the order code below 2.1, these specifications apply accordingly, provided that they correspond to the standard version.

2.3 Comprehensive quality insurance to 2006/42/EC

Schmersal is a certified company to appendix X of the Machinery Directive. As a result, Schmersal is entitled to autonomously conduct the conformity assessment procedure for the products listed in Appendix IV of the MD without involving a notified body. The EC prototype test certificates are available upon request or can be downloaded from the Internet at www.schmersal.com.

2.4 Destination and use

This non-contact, electronic safety sensor is designed for application in safety circuits and is used for monitoring the position of movable safety guards. In this application, the safety sensor monitors the position of hinged, sliding or removable safety guards by means of the coded electronic CST 34 or CST 180 actuators (refer to table "Actuators and switching distances").

The diagnostic output of the safety sensor can alternatively be used as conventional output or as "serial output" with input and output channel. The serial connections of the individual sensors are wired in series together with other devices and connected to a Field Bus Gateway.



The safety switchgears are classified according to ISO 14119 as type 4 switching devices.

Mode of operation of the safety outputs

The safety outputs can be integrated into the safety circuit of the control system. The opening of a safety guard, i.e. the actuator is removed out of the active zone of the sensor, will immediately disable the safety outputs of the CSS 34 sensor (refer to table "Actuators and switching distances").

Any error that does not immediately affect the functionality of the safety sensor (e.g. the ambient temperature being too high, interference potential at a safety output, cross-wire short) will lead to a delayed shut-down. The safety outputs are disabled after 30 minutes if the error is not rectified.

The signal combination, diagnostic output disabled and safety channels still enabled, can be used to stop the production process in a controlled manner.

After fault rectification, the error message is reset by opening and re-closing the corresponding safety guard. The safety outputs enable and allow a restart.

For devices with serial diagnostic, a bit can be set/deleted in the call telegram to reset the fault.

Series-wiring

Max. 31 sensors can be wired in series. In this way, a 200 m long sensor chain can be set up.



The user must evaluate and design the safety chain in accordance with the relevant standards and the required safety level. If multiple safety sensors are involved in the same safety function, the PFH values of the individual components must be added.



The entire concept of the control system, in which the safety component is integrated, must be validated to the relevant standards.

2.5 Technical data

Standards:	IEC 60947-5-3; ISO 13849-1; IEC 61508, IEC 62061
Enclosure:	glass-fibre reinforced thermoplastic
Operating principle:	inductive
Coding levels according to ISO 14119:	low
Actuator and switch distances (according to IEC 60947-5-3):	see table "Actuator / Switch distances"
Hysteresis:	max: 1.5 mm
Repeat accuracy R:	< 0.5 mm
Switching frequency f:	3 Hz
Series-wiring:	max. 31 devices
Cable length:	max. 200 m
Connector:	M12, 8-pin in casing
Pre-wired cable:	Y-UL 2517 / 8 × AWG 22 / 8 × 0.35 mm ² , 2 m
Temperature resistance of the cable:	
- at rest:	-30 °C ... +105 °C
- in motion:	-10 °C ... +105 °C
Ambient conditions:	
Ambient temperature T _u :	-25 °C to +70 °C
	with output current ≤ 0.1 A / Output -25 °C to +65 °C
	with output current ≤ 0.25 A / Output
Storage and transport temperature:	-25 °C ... +85 °C
Resistance to vibration:	10 ... 55 Hz, amplitude 1 mm
Resistance to shock:	30 g / 11 ms
Protection class:	IP65, IP67 to IEC 60529
Electrical data:	
Rated operating voltage U _e :	24 VDC -15% / +10% (stabilised PELV to IEC 60204-1)
Rated operating current I _e :	0.6 A
Required rated short-circuit current:	100 A
Fuse (line protection):	note the wire diameter of continuing wire:
- for wire variants:	up to 45 °C ambient temperature: 4.0 A up to 60 °C ambient temperature: 3.15 A up to 65 °C ambient temperature: 2.5 A up to 70 °C ambient temperature: 2.0 A
- for plug version:	2.0 A
Rated insulation voltage U _i :	32 VDC
Rated impulse withstand voltage U _{imp} :	800 V
No-load current I ₀ :	0.1 A
Response time:	< 30 ms
Duration of risk:	< 60 ms
Protection class:	II
Overvoltage category:	III
Degree of pollution:	3
EMC rating:	according to IEC 60947-5-3
Electromagnetic interference:	according to IEC 60947-5-3
Safety outputs Y1/Y2:	normally open function, 2 channel, p-type, short-circuit proof
Rated operating voltage U _{e1} :	max. 1 V below U _e
Leakage current I _r :	< 0.5 mA
Rated operating current I _{e1} :	max. 0.25 A, dependent on ambient temperature
Minimum operating current I _m :	0.5 mA
Utilisation category:	DC-12, DC-13
Rated operating voltage/current U _{e1} /I _{e1} :	24 VDC / 0.25 A
Diagnostic output:	short-circuit proof, p-type
Voltage drop:	< 5 V
Rated operating voltage U _{e2} :	min. (U _e - 5 V)
Operating current I _{e2} :	max. 0,05 A
Utilisation category:	DC-12, DC-13
Rated operating voltage/current U _{e2} /I _{e2} :	24 VDC / 0.05 A
Wiring capacitance for serial diagnostics:	max. 50 nF

2.6 Safety classification

Standards:	ISO 13849-1, IEC 61508, IEC 62061
PL:	e
Control Category:	4
PFH value:	3.6 x 10 ⁻⁹ / h
SIL:	suitable for SIL 3 applications
Service life:	20 years

3. Mounting

3.1 General mounting instructions



During fitting, the requirements of ISO 14119 must be observed.

The component can be mounted in any position. The active surface of the safety sensor and the actuator has to be opposite. The sensor enclosure must not be used as an end stop. The active surface of the safety sensor is either the lateral surface marked with the type plate or the front, rounded surface. The safety sensor must only be used within the assured switching distances ≤ s_{ao} and ≥ s_{ar}.

The safety sensor and the CST 34-1 or CST 34-S-2 actuators are supplied with integrated mounting plate. With the slotted holes of the mounting plates, possible tolerances can be horizontally and vertically compensated. The components are fitted with M4 screws.

The safety sensors and the actuators can be clipped onto the mounting plate with different actuating directions. Both components are fixed by means of a locking cap.



Safety sensor and actuator must be permanently fitted to the safety guards and protected against displacement by suitable measures (tamperproof screws, gluing, drilling of the screw heads).



The mounting plates must be pinned after their fixation. The mounting brackets also must be secured by means of the supplied locking pin to protect them against tampering. The CST-S-3 and CST 180 actuators must be protected by tamper-proof screws or a tamper-proof fitting.

At an ambient temperature of over 55°C, the safety sensor must be fitted so that it is protected against unintentional contact with persons.

To avoid any interference inherent to this kind of system and any reduction of the switching distances, please observe the following guidelines:

Minimum distance between two sensors: 100 mm

3.2 Dimensions

All measurements in mm.

Safety sensor size

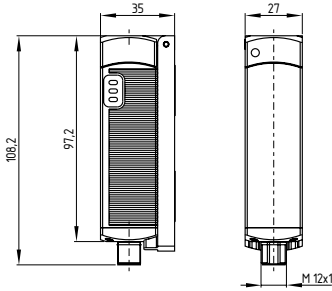

Dimensions Actuator

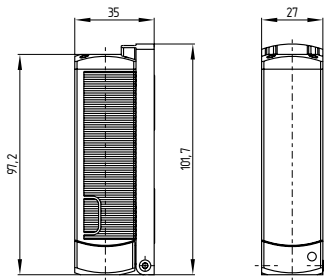

Alternative suitable actuators with different design: refer to www.schmersal.net.

Integrated mounting plate

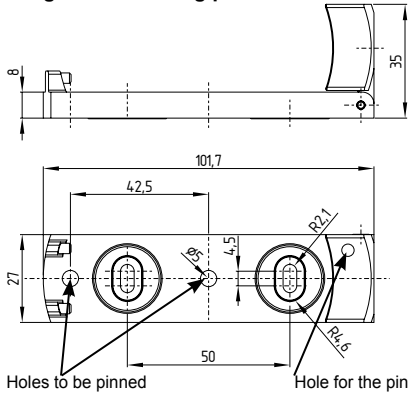

3.3 Actuating positions of the safety sensor with regard to the actuator

Lateral actuation	Actuation from front
CST 34-S-1 CSS ...-34-S	CSS ...-34-V CST 34-V-1
CST 34-S-3 CSS ...-34-S	CSS ...-34-V CST 34-S-3
CST 34-S-2 CSS ...-34-S	CSS ...-34-V CST 34-S-2
CST 180-1/2 CSS ...-34-S	CSS ...-34-V CST 180-1/2

3.4 Switching distance

Actuators and switching distances (to EN 60947-5-3)

Actuator	Sensor	CSS ...-34-S (Actuation from side)	CSS ...-34-V (Actuation from front)
CST 34-V-1	S_n	10 mm	12 mm
	S_{ao}	8 mm	10 mm
	S_{ar}	13 mm	15 mm
CST 34-S-1 CST 34-S-3	S_n	14 mm	15 mm
	S_{ao} S_{ar}	12 mm 17 mm	13 mm 18 mm
CST 34-S-2 (increased misalignment)	S_n	14 mm	10 mm
	S_{ao}	12 mm	8 mm
	S_{ar}	17 mm	16 mm
CST 180-1 CST 180-2	S_n	10 mm	12 mm
	S_{ao}	8 mm	10 mm
	S_{ar}	13 mm	16 mm

Key

- S_n Rated operating distance
- S_{ao} Assured switching distance
- S_{ar} Assured switch-off distance

Maximum misalignment from side

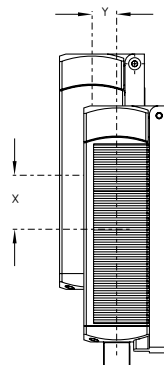

Actuation from side

The side allows for a maximum height misalignment (X) of sensor and actuator of 36 mm (e.g. mounting tolerance or due to guard door sagging). Increased misalignment, max. 53 mm, possible when the CST 34-S-2 actuator is used. The axial misalignment (Y) is max. ± 10 mm.

Maximum misalignment from front

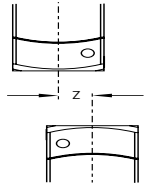

Actuation from front

The front face allows for an axial misalignment (Z) of max. ± 8 mm.

3.5 Adjustment

The distance between the sensor and the actuator must be set to < Sao.

If variations in the clearance between the sensor and the actuator is detected (e.g. sagging of a safety guard), this distance must be reduced by 4 mm. The yellow LED's and the diagnostic output indicate the different ranges.

4. Electrical connection

4.1 General information for electrical connection



The electrical connection may only be carried out by authorised personnel in a de-energised condition.

The power supply for the safety sensors must provide protection against permanent overvoltage. Under fault conditions, the voltage must not exceed 60 V. supply units according to IEC 60204-1 is recommended.

Requirements for the connected safety-monitoring module

Dual-channel safety input, suitable for p-type safety sensors with NO function. The safety sensors cyclically switch off the output to test them. The switch-off times of max. 500 μ s must be tolerated by the evaluating device. Short-circuit recognition by the evaluation is not necessary. Note on the total length of a safety sensor chain, refer to paragraph "Series-wiring". The maximum load current of 250 mA per safety channel must be observed. Contactors with higher load currents must be controlled by intermediate control relays.



Information for the selection of suitable safety-monitoring modules can be found in the Schmersal catalogues or in the online catalogue on the Internet: www.schmersal.net.



If the safety sensor is connected to electronic safety-monitoring modules, we recommend that you set a discrepancy time of 100 ms. The safety inputs of the safety-monitoring module must be able blanking a test impulse of approx. 1 ms. The safety-monitoring module does not need to have a cross-wire short monitoring function, if necessary, the cross-wire short monitoring function must be disabled.

Wiring capacitance for serial diagnostics

The connecting cable of the safety sensor must have a maximum length of 200 m; its wiring capacitance must not exceed 50 nF. Depending on the strand structure, normal unshielded 200 m long control cables LIYY 0.25 mm² to 1.5 mm² have a wiring capacitance of approx. 20 ... 48n F

The self-monitoring safety sensors of the CSS 34F0 or CSS 34F1 series can replace the safety-monitoring module. Therefore, they can only be used as the first sensor of a series-wired sensor chain. (refer to operating instructions CSS 34F0 / CSS 34F1).

The safety outputs can be integrated into the safety circuit of the control system. For applications of PL e / control category 4 to ISO 13849-1, the safety outputs of the safety sensor or sensor of the chain must be wired to a safety monitoring module of the same control category .

4.2 Series-wiring

Series-wiring can be set up. The number of devices is limited for safety reasons. Series-wiring of CSS 34-...-SD with serial diagnostics is possible for up to 31 devices.

A 200 m long sensor chain can be set up. Please note that voltage losses could occur (due to cable length, cable section, voltage drop/sensor)! For longer cable lengths, the section of the connecting cables must be taken as large as possible.

Wiring examples for series-wiring, refer to appendix

Protection is not required when pilot wires are laid. The cables however must be separated from the supply and energy cables. The max. fuse rate for a sensor chain depends on the section of the connecting cable of the sensor.



When wiring SD devices, please observe the voltage drop on the cables and the current carrying capacity of the individual components.

5. Set-up and maintenance

5.1 Functional testing

The safety function of the safety components must be tested. The following conditions must be previously checked and met:

1. Fitting of the sensor and the actuator
2. Fitting and integrity of the power cable
3. The system is free of dirt and soiling (in particular metal chips)

5.2 Maintenance

In the case of correct installation and adequate use, the safety sensor features maintenance-free functionality.

A regular visual inspection and functional test, including the following steps, is recommended:

- Check the fitting of the safety sensor and the actuator
- Remove possible metal chips
- Check the cable for damage.



Measures must be taken to protect against manipulation or against the bypassing of safety device, for example, using an extra actuator.

Damaged or defective components must be replaced.

6. Diagnostic functions

6.1 Operating principle of the diagnostic LED's







The safety sensor indicates the operating condition and faults by means of three-colour LED's located in the lateral surfaces of the sensor.

The green LED indicates that the safety sensor is ready for operation. The sensor is not actuated.
The yellow LED indicates the switching condition of the safety outputs.

When the safety sensor is actuated by the actuator, the indication LED switches from green to yellow. The safety outputs of the safety sensor are enabled. If the actuator is near the limit of the sensor's switching distance, the yellow LED will flash. The safety outputs remain enabled.

The flashing can be used to prematurely detect variations in the clearance between the sensor and the actuator (e.g. sagging of a safety guard). The sensor must be adjusted before the distance to the actuator increases and before the safety outputs are disabled, thus stopping the machine. If an error is detected, the red LED will be activated.

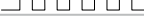
Flash codes red diagnostic LED

LED indication (red)		Error cause
1 flash pulse		Error output Y1
2 flash pulses		Error output Y2
3 flash pulses		Cross-wire Y1/Y2
4 flash pulses		ambient temperature too high
5 flash pulses		Wrong or defective actuator
Continuous red		Internal error

6.2 Operating principle of the electronic diagnostic output

The short-circuit proof diagnostic output can be used for central visualisation or control functions, e.g. in a PLC.
The electronic diagnostic output signals faults before the safety outputs are disabled, thus enabling a controlled shutdown.

The diagnostic output is not a safety-related output!

The closed condition of the safety guard, i.e. the sensor is actuated, is indicated through a positive signal. If the sensor is operating near the limit of its switching distance, e.g. due to the sagging of the safety guard, the sensor will emit a 1 Hz cyclic signal before the safety outputs are disabled.

The diagnostic output can also be used to detect clearance variations between the sensor and the actuator in the same way as the yellow LED.

An active fault causes the diagnostic output to be disabled. The safety outputs are disabled after max. 30 minutes if the fault is not rectified. The signal combination, diagnostic output disabled and safety channels still enabled, can be used to stop the production process in a controlled manner.

Table 1: Examples of the diagnostic function of the safety-sensor with conventional diagnostic output

Sensor function		LED green	red	yellow	Diagnos- tic output	Safety outputs Y1, Y2	Note
I.	Supply voltage	On	Off	Off	0 V	0 V	Voltage on, no evaluation of the voltage quality
II.	actuated	On	Off	On	24 V	24 V	The yellow LED always signals the presence of an actuator within range
III.	Actuated, actua- tor in limit area	On	Off	Flashes (1Hz)	24 V pulsed	24 V	The sensor must be adjusted before the distance to the ac- tuator increases and before the safety outputs are disabled, thus stopping the machine
IV.	Error warning, sensor actuated	On	Flashes	On	0 V	24 V	After 30 minutes if the error is not rectified
V.	Error	On	Flashes	On	0 V	0 V	Refer to table with flash codes

6.3 Safety-sensors with serial diagnostic function

Safety sensors with serial diagnostic cable have a serial input and output cable instead of the conventional diagnostic output. If CSS sensors are daisy-chained, the diagnostic data are transmitted through the series-wiring of the inputs and outputs.

Max. 31 sensors can be wired in series. For the evaluation of the serial diagnostics line either the PROFIBUS-Gateway SD-I-DP-V0-2 or the Universal-Gateway SD-I-U-... are used. This serial diagnostic interface is integrated as a slave in an existing field bus system. In this way, the diagnostic signals can be evaluated by means of a PLC. The necessary software for the integration of the SD-Gateway is available for download at www.schmersal.net.



Accessories SD interface

For ease of wiring and series-wiring of SD devices, considerable accessories are available. Detailed information is available on the Internet, www.schmersal.net.

The response data and the diagnostic data are automatically and permanently written in the assigned input byte of the PLC for each safety sensor in the series-wired chain. The request data for each safety sensor are transmitted to the device through an output byte of the PLC.

In the event of a communication error between the field bus Gateway and the safety sensor, the switching condition of the safety output of the safety sensor is maintained.

The following operational information is automatically and permanently written in an input byte of the PLC for each CSS 34 sensor of the series-wired chain (see table 2 and table 3):

- Bit 0: safety outputs enabled
- Bit 1: safety sensor actuated, actuator identified
- Bit 4: both safety inputs live
- Bit 5: safety sensor actuated in hysteresis area
- Bit 6: error warning, switch-off delay activated
- Bit 7: error, safety outputs switched off

Error

A fault has occurred, which causes the safety outputs to be disabled. The fault is reset, when the cause is eliminated and bit 7 of the request byte changes from 1 to 0 or the safety guard is opened. Faults at the safety outputs are only deleted upon the next release, as the fault rectification cannot be detected sooner.

Error warning

A fault has occurred, which causes the safety outputs to be disabled after 30 minutes. The safety outputs initially remain enabled. This enables the shutdown of the process in a controlled manner. An error warning is deleted when the cause of error is eliminated.

Table 2: Function of the visual diagnostic LED's, the serial status signals and the safety outputs by means of an example

System condition	LED			Safety outputs Y1, Y2	serial diagnostic byte bit no.								
	green	red	yellow		7	6	5	4	3	2	1	0	
Supply voltage on, not actuated	On	Off	Off	0 V	0	0	0	0	0	0	0	0	0
Actuated, safety outputs enabled	On	Off	On	24 V	0	0	0	1	0	0	1	1	1
Actuated in limit area	On	Off	Flashes (1Hz)	24 V	0	0	1	1	0	0	1	1	1
Actuated, warning	On	On/flashes	On	24 V	0	1	0	1	0	0	1	1	1
Actuated, fault	On	On/flashes	On	0 V	1	1	0	1	0	1	1	1	0

The shown bit order of the diagnostic byte is an example. A different combination of the operational conditions will lead to a change of the bit order.

Table 3: I/O data and diagnostic data

Communication directions: Request byte: from the PLC to the local safety sensor
 Response byte: from the local safety sensor to the PLC
 Warning/error byte: from the local safety sensor to the PLC

Bit n°	Request byte	Response byte	Diagnostic error warning	Diagnostic error
Bit 0:	Error reset	Safety output activated	Error output Y1	Error output Y1
Bit 1:	---	Actuator detected	Error output Y2	Error output Y2
Bit 2:	---	---	Cross-wire Y1/Y2	Cross-wire Y1/Y2
Bit 3:	---	---	Temperature too high	Temperature too high
Bit 4:	---	Input condition X1 and X2	---	incorrect or defective actuator
Bit 5:	---	Actuated in limit area	Internal device error	Internal device error
Bit 6:	---	Error warning	Communication error between the field bus Gateway and the safety switch	---
Bit 7:	Error reset	Error (enabling path switched off)	Operating voltage too low	---

The described condition is reached, when Bit = 1

7. Disassembly and disposal

7.1 Disassembly

The safety switchgear must be disassembled in a de-energised condition only.

7.2 Disposal

The safety switchgear must be disposed of in an appropriate manner in accordance with the national prescriptions and legislations.

8. Appendix

8.1 Wiring examples

The application examples shown are suggestions. They however do not release the user from carefully checking whether the switchgear and its set-up are suitable for the individual application.

Wiring example 1

Series-wiring of the CSS 34 with conventional diagnostic output

The voltage is supplied to both safety inputs of the last safety sensor of the chain (considered from the safety-monitoring module). The safety outputs of the first safety sensor are wired to the safety-monitoring module.

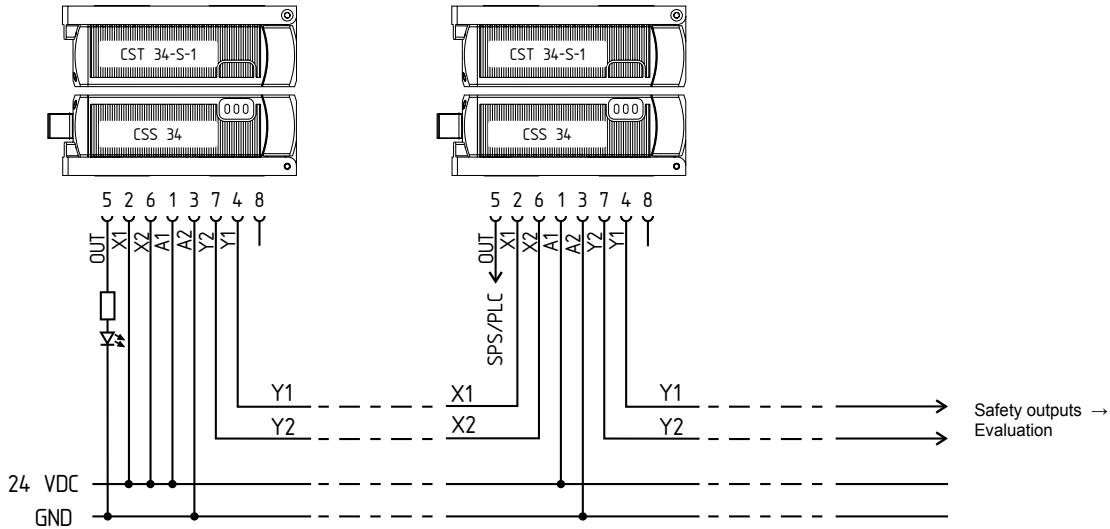

Y1 and Y2 = Safety outputs Safety monitoring module

Wiring example 2

Series-wiring of the CSS 34 with serial diagnostic function

The safety outputs of the first safety sensor are wired to the safety-monitoring module. The serial Diagnostic Gateway is connected to the serial diagnostic input of the first safety sensor.

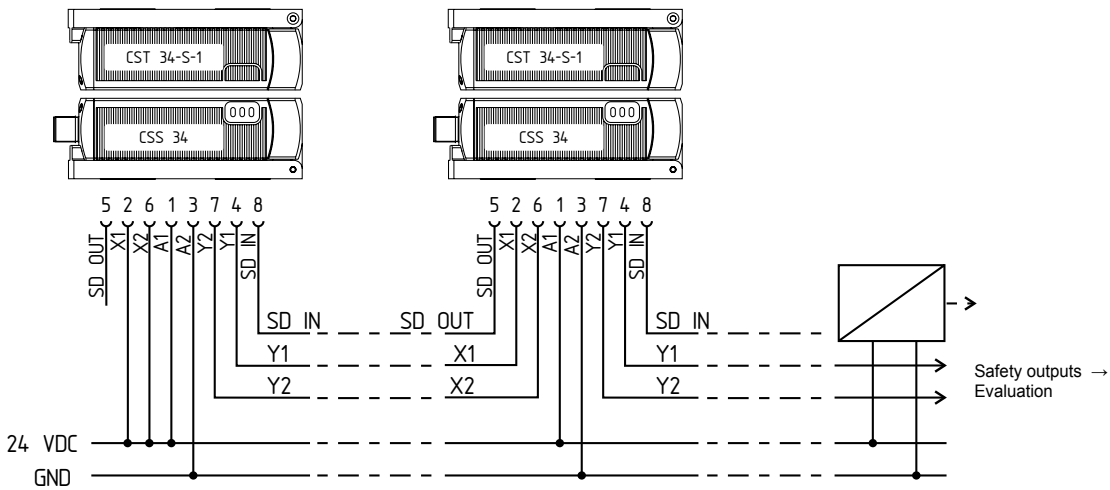

Y1 and Y2 = Safety outputs Safety monitoring module

SD-IN -> SD-i-DP = PROFIBUS

8.2 Connection example

Schedule 4: Wiring of the safety sensor with cable or integrated connector

Function safety switchgear		Pin configuration of the integrated connector	Colour code of the Schmersal connector or the integrated cable	possible colour codes of other conventional connectors		
				to IEC 60947-5-2: 2008	to DIN 47100	
A1	with conventional diagnostic output	U _e	1	BN	BN	WH
X1		Safety input 1	2	WH	WH	BN
A2		GND	3	BU	BU	GN
Y1		Safety output 1	4	BK	BK	YE
OUT	Diagnostic output	SD output	5	GY	GY	GY
X2		Safety input 2	6	VT	PK	PK
Y2		Safety output 2	7	RD	VT	BU
IN	without function	SD input	8	PK	OR / shielded	RD

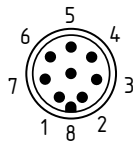
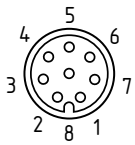

Connecting cables with coupling (female)

IP67, M12, 8-pole - 8 x 0.23 mm²

Cable length 2.5 m **101209963**

Cable length 5 m **101209964**

Cable length 10 m **101209960**

IP69K, M12, 8-pole - 8 x 0.21 mm²

Cable length 5 m **101210560**

Cable length 5 m, angled **101210561**

9. Declaration of conformity

9.1 EC Declaration of conformity

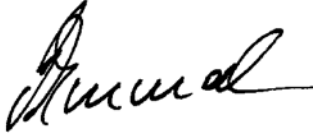
	
<h2>EC Declaration of conformity</h2>	
Translation of the original Declaration of Conformity	K.A. Schmersal GmbH & Co. KG Möddinghofe 30 42279 Wuppertal Germany Internet: www.schmersal.com
<p>We hereby certify that the hereafter described safety components both in its basic design and construction conform to the applicable European Directives.</p>	
Name of the safety component:	CSS 34
Type:	Refer to ordering code
Description of the safety component:	Non-contact safety sensor
Relevant EC-Directives:	2006/42/EC EC-Machinery Directive 2004/108/EC EMC-Directive
Person authorised for the compilation of the technical documentation:	Oliver Wacker Möddinghofe 30 42279 Wuppertal
Notified body, which approved the full quality assurance system, referred to in Appendix X, 2006/42/EC:	TÜV Rheinland Industrie Service GmbH Alboinstr. 56 12103 Berlin ID n°: 0035
Place and date of issue:	Wuppertal, March 10, 2015
CSS34-D-EN	
	Authorised signature Philip Schmersal Managing Director



The currently valid declaration of conformity can be downloaded from the internet at www.schmersal.net.



K.A. Schmersal GmbH & Co. KG
Möddinghofe 30, D - 42279 Wuppertal
Postfach 24 02 63, D - 42232 Wuppertal

Phone: +49 - (0)2 02 - 64 74 - 0
Telefax: +49 - (0)2 02 - 64 74 - 1 00
E-Mail: info@schmersal.com
Internet: <http://www.schmersal.com>