



**EN** Operating instructions. . . . .pages 1 to 6  
Translation of the original operating instructions

**Content**

**1 About this document**

1.1 Function . . . . . 1

1.2 Target group: authorised qualified personnel. . . . . 1

1.3 Explanation of the symbols used . . . . . 1

1.4 Appropriate use . . . . . 1

1.5 General safety instructions . . . . . 1

1.6 Warning about misuse . . . . . 2

1.7 Exclusion of liability . . . . . 2

**2 Product description**

2.1 Ordering code . . . . . 2

2.2 Special versions. . . . . 2

2.3 Destination and use . . . . . 2

2.4 Technical data . . . . . 2

2.5 Safety classification . . . . . 2

**3 Mounting**

3.1 General mounting instructions . . . . . 3

3.2 Dimensions . . . . . 3

3.3 Axial misalignment. . . . . 3

3.4 Adjustment. . . . . 3

**4 Electrical connection**

4.1 General information for electrical connection. . . . . 3

4.2 Contact variants. . . . . 4

**5 Set-up and maintenance**

5.1 Functional testing. . . . . 4

5.2 Maintenance . . . . . 4

**6 Disassembly and disposal**

6.1 Disassembly. . . . . 4

6.2 Disposal . . . . . 4

**7 Appendix**

7.1 EC Declaration of conformity . . . . . 5

**1. About this document**

**1.1 Function**

This operating instructions manual provides all the information you need for the mounting, set-up and commissioning to ensure the safe operation and disassembly of the safety switchgear. The operating instructions must be available in a legible condition and a complete version in the vicinity of the device.

**1.2 Target group: authorised qualified personnel**

All operations described in this operating instructions manual must be carried out by trained specialist personnel, authorised by the plant operator only.

Please make sure that you have read and understood these operating instructions and that you know all applicable legislations regarding occupational safety and accident prevention prior to installation and putting the component into operation.

The machine builder must carefully select the harmonised standards to be complied with as well as other technical specifications for the selection, mounting and integration of the components.

**1.3 Explanation of the symbols used**



**Information, hint, note:**

This symbol is used for identifying useful additional information.



**Caution:** Failure to comply with this warning notice could lead to failures or malfunctions.

**Warning:** Failure to comply with this warning notice could lead to physical injury and/or damage to the machine.

**1.4 Appropriate use**

The products described in these operating instructions are developed to execute safety-related functions as part of an entire plant or machine. It is the responsibility of the manufacturer of a machine or plant to ensure the correct functionality of the entire machinery or plant.

The safety switchgear must be exclusively used in accordance with the versions listed below or for the applications authorised by the manufacturer. Detailed information regarding the range of applications can be found in the chapter "Product description".

**1.5 General safety instructions**

The user must observe the safety instructions in this operating instructions manual, the country-specific installation standards as well as all prevailing safety regulations and accident prevention rules.



Further technical information can be found in the Schmersal catalogues or in the online catalogue on the Internet: [www.schmersal.net](http://www.schmersal.net).

The information contained in this operating instructions manual is provided without liability and is subject to technical modifications.

There are no residual risks, provided that the safety instructions as well as the instructions regarding mounting, commissioning, operation and maintenance are observed.

1.6 Warning about misuse



In case of improper use or manipulation of the safety switch-gear, personal hazards or damages to machinery or plant components cannot be excluded. The relevant requirements of the standard EN 1088 must be observed.

1.7 Exclusion of liability

We shall accept no liability for damages and malfunctions resulting from defective mounting or failure to comply with this operating instructions manual. The manufacturer shall accept no liability for damages resulting from the use of unauthorised spare parts or accessories.

For safety reasons, invasive work on the device as well as arbitrary repairs, conversions and modifications to the device are strictly forbidden; the manufacturer shall accept no liability for damages resulting from such invasive work, arbitrary repairs, conversions and/or modifications to the device.

2. Product description

2.1 Ordering code

This operating instructions manual applies to the following types:

EX-BNS 120-①Z-3G/D

No.	Option	Description
①	11	1 NO contact / 1 NC contact
	12	1 NO contact / 2 NC contacts
	02	2 NC contacts

2.2 Special versions

For special versions, which are not listed in the order code below 2.1, these specifications apply accordingly, provided that they correspond to the standard version.

2.3 Destination and use

The safety sensor can be used for monitoring the position of movable guards and flaps in explosion-endangered areas of Zone 2 and 22 category 3GD. The installation and maintenance requirements to the standard series EN 60079 must be met. To actuate the safety sensors, only the BP 6, BP 8, BP 10 or BP 15 SS actuators can be used.

The safety switches are used for applications, in which the hazardous situation is terminated without delay when the safety guard is opened.

Only the entire system consisting of the safety sensor (EX-BNS), the actuator (BP) and the safety-monitoring module (AES/SRB/AZR) meet the requirements of the standard EN 60947-5-3.

Conditions for safe operation

Due to their specific impact energy, the components must be fitted with a protection against mechanical stresses. The specific ambient temperature range must be observed. The user must provide for a protection against the permanent influence of UV rays.



The user must evaluate and design the safety chain in accordance with the relevant standards and the required safety level.



The entire concept of the control system, in which the safety component is integrated, must be validated to the relevant standards.

2.4 Technical data

Equipment category:	© II 3GD
Ex protection:	Ex nC IIC T6 Gc X; Ex tc IIIC T80°C Dc X
Standards:	IEC 60947-5-3; EN 60079-0; EN 60079-15; EN 60079-31; BG-GS-ET-14
Design:	cylindrical
Tightening torque:	SW 17 max. 90 Ncm
Enclosure:	glass-fibre reinforced thermoplastic
Max. impact energy:	1 J
Protection class:	IP67 to EN 60529
Connection:	Boflex cable
Cable section:	4 x 0.25 mm <sup>2</sup>
Operating principle:	magnetic
Actuating magnet:	BP 6; BP 8; BP 10; BP 15 SS; not coded
Assured switching distance $s_{so}$ :	10 mm (BP 6 / BP 8) 20 mm (BP 10 / BP 15 SS)
Assured switch-off distance $s_{ar}$ :	22 mm (BP 6 / BP 8) 32 mm (BP 10 / BP 15 SS)
Switching condition indication:	LED only with ordering suffix G
Max. switching voltage:	100 VAC / DC
Switching current:	max. 250 mA
Max. switching capacity:	-02Z: 3 W, -11Z, -12Z: 5 W
Ambient temperature:	-25 °C ... +70 °C
Storage and transport temperature:	-25 °C ... +70 °C
Max. switching frequency:	5 Hz
Resistance to shock:	30 g / 11 ms
Resistance to vibration:	10 ... 55 Hz, amplitude 1 mm

2.5 Safety classification

Standards:	EN ISO 13849-1
$B_{10d}$ (NC/NO contact):	25,000,000 at max. 20 % contact load
Service life:	20 years

$$MTTF_d = \frac{B_{10d}}{0,1 \times n_{op}} \quad n_{op} = \frac{d_{op} \times h_{op} \times 3600 \text{ s/h}}{t_{cycle}}$$

(Specifications can vary depending on the application-specific parameters  $h_{op}$ ,  $d_{op}$  and  $t_{cycle}$  as well as the load.)

An individual switch can be used in a category 3 or 4 architecture up to PL e.

If multiple safety components are wired in series, the Performance Level to EN ISO 13849-1 will be reduced due to the restricted error detection under certain circumstances.

3. Mounting

3.1 General mounting instructions

- Fitting is only authorised in a de-energised condition
- The safety sensor and the actuator must be fitted in a concealed mounting position in order to avoid a neutralisation of the sensor's function by simple means.
- Screw both nuts in the provided mounting holes to fix the safety sensor (max. tightening torque 90 Ncm)
- Do not use the sensor and the actuator as a mechanical backstop
- Any mounting position; Prerequisite: install the northpole of the magnet at the front end of the sensor
- Inseparably fix the safety sensor and the actuator to the safety guard

To avoid any interference inherent to this kind of system and any reduction of the switching distances, please observe the following guidelines:

- Do not install the safety sensor and the actuator in strong magnetic fields
- If possible, do not install the safety sensor and the actuator on ferromagnetic material.
- Do not subject the safety sensor and actuator to extreme vibrations and shocks.
- Keep away from metal chips
- The mounting distance between two sensors should always be at least 50 mm



Please observe the specifications for the maximum impact energy in the technical data.

3.2 Dimensions

All measurements in mm.

Safety sensor with cable

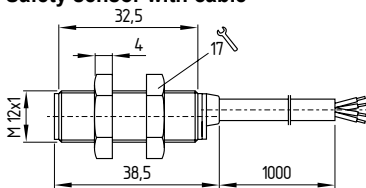

Actuator, unenclosed

BP 6

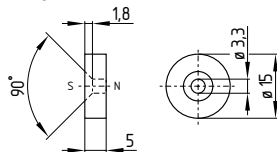

BP 8

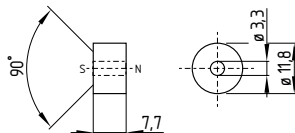

BP 10

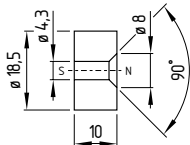

Actuator for food-processing industry, with metal enclosure

BP 15 SS

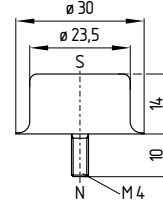

3.3 Axial misalignment

A horizontal and vertical misalignment of the safety sensor and the actuator is tolerated. The possible misalignment depends on the distance of the active surfaces of the sensor and the actuator. The sensor remains active within the tolerance range.

The specified switching distances refer to oppositely mounted safety sensors and actuators.

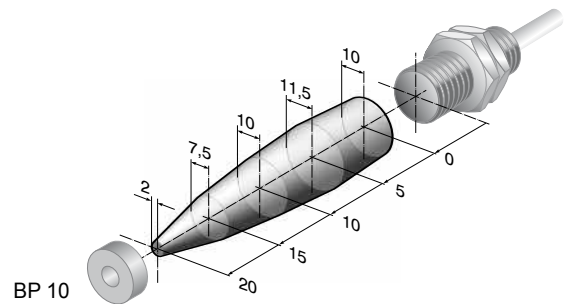

Assured switching distance:  $s_{ao} = 10 \text{ mm}$  (BP 6 / BP 8)  
 $s_{ao} = 20 \text{ mm}$  (BP 10 / BP 15 SS)

Assured switch-off distance  $s_{ao} = 22 \text{ mm}$  (BP 6 / BP 8)  
 $s_{ao} = 32 \text{ mm}$  (BP 10 / BP 15 SS)

3.4 Adjustment

The proper functionality must always be checked by means of the connected safety-monitoring module.

4. Electrical connection

4.1 General information for electrical connection



The electrical connection may only be carried out by authorised personnel in a de-energised condition.

The safety sensors must be wired in accordance with the specified wire colours.

Inductive loads (e.g. contactors, relays, etc.) are to be provided with suitable interference suppression circuitry.

### 4.2 Contact variants

The contact position shows the actuated sensor function when the safety guard is closed.

#### 1 NO contact / 1 NC contact

EX-BNS 120-11Z-3G/D

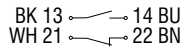

#### 1 NO contact / 2 NC contacts

EX-BNS 120-12Z-3G/D

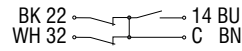

#### 2 NC contacts

EX-BNS 120-02Z-3G/D

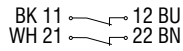

Information for the selection of suitable safety-monitoring modules can be found in the Schmersal catalogues or in the online catalogue on the Internet: [www.schmersal.net](http://www.schmersal.net).

Connecting multiple safety sensors to one suitable safety-monitoring module is technically possible. To connect multiple safety sensors (check if authorised!), their NO contacts are wired in parallel and their NC contacts in series. The Protect-IE-11 or -02 or PROTECT-PE-11 (-AN) input expander module can be used to connect up to 4 safety sensors with NC/NC or NC/NO contacts.

Connecting more than two EX-BNS 120-12Z3G/D safety sensors to the AES 1102/1112 or 7112 safety-monitoring module is not possible. For connecting only one safety sensor: refer to the operating instructions manual of the AES 7112 or AES 1102/1112.

## 5. Set-up and maintenance

### 5.1 Functional testing

The safety function of the safety components must be tested. The following conditions must be previously checked and met:

1. The installation is executed according to the instructions
2. The connection is executed correctly
3. The safety component is not damaged
4. Fitting and integrity of the power cable
5. The system is free of dirt and soiling (in particular metal chips)
6. Check cable entry and connections in a de-energised condition

### 5.2 Maintenance

In the case of correct installation and adequate use, the safety sensor features maintenance-free functionality. A regular visual inspection and functional test, including the following steps, is recommended:

- Check the fitting of the sensor and the actuator
- Remove possible metal chips
- Check the cable for damage.
- Check cable entry and connections in de-energised condition

**Damaged or defective components must be replaced.**

## 6. Disassembly and disposal

### 6.1 Disassembly

The safety switchgear must be disassembled in a de-energised condition only.

### 6.2 Disposal

The safety switchgear must be disposed of in an appropriate manner in accordance with the national prescriptions and legislations.

7. Appendix

7.1 EC Declaration of conformity

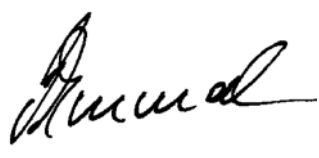
	
<h2>EC Declaration of conformity</h2>	
Translation of the original Declaration of Conformity	K.A. Schmersal GmbH & Co. KG Möddinghofe 30 42279 Wuppertal Germany Internet: www.schmersal.com
<p>We hereby certify that the hereafter described safety components both in its basic design and construction conform to the applicable European Directives.</p>	
<b>Name of the safety component:</b>	EX-BNS 120 ⊕ II 3G Ex nC IIC T6 Gc X ⊕ II 3D Ex tc IIIC T80°C Dc X
<b>Description of the safety component:</b>	Safety sensor with magnetic operating principle in combination with the AES and SRB safety-monitoring modules from Schmersal
<b>Relevant EC-Directives:</b>	2006/42/EC EC-Machinery Directive 94/9/EC EC-Explosion Protection Directive (ATEX)
<b>Person authorized for the compilation of the technical documentation:</b>	Oliver Wacker Möddinghofe 30 42279 Wuppertal
<b>Place and date of issue:</b>	Wuppertal, June 6, 2014
EX-BNS120-C-EN	
	Authorised signature <b>Philip Schmersal</b> Managing Director



The currently valid declaration of conformity can be downloaded from the internet at [www.schmersal.net](http://www.schmersal.net).



**K. A. Schmersal GmbH & Co. KG**  
Möddinghofe 30, D - 42279 Wuppertal  
Postfach 24 02 63, D - 42232 Wuppertal

Phone: +49 - (0)2 02 - 64 74 - 0  
Telefax: +49 - (0)2 02 - 64 74 - 1 00  
E-Mail: [info@schmersal.com](mailto:info@schmersal.com)  
Internet: <http://www.schmersal.com>