



**EN** Operating instructions. . . . . pages 1 to 10  
Original

**Content**

**1 About this document**

1.1 Function . . . . . 1

1.2 Target group: authorised qualified personnel. . . . . 1

1.3 Explanation of the symbols used . . . . . 1

1.4 Appropriate use . . . . . 1

1.5 General safety instructions . . . . . 1

1.6 Warning about misuse . . . . . 2

1.7 Exclusion of liability . . . . . 2

**2 Product description**

2.1 Ordering code . . . . . 2

2.2 Special versions . . . . . 2

2.3 Comprehensive quality insurance to 2006/42/EC . . . . . 2

2.4 Destination and use . . . . . 2

2.5 Technical data . . . . . 3

2.6 Safety classification . . . . . 3

**3 Mounting**

3.1 General mounting instructions . . . . . 3

3.2 Dimensions . . . . . 4

3.3 Switching distance . . . . . 4

3.4 Adjustment . . . . . 4

**4 Electrical connection**

4.1 General information for electrical connection. . . . . 4

4.2 Serial diagnostic -SD . . . . . 5

**5 Operating principles and coding**

5.1 Mode of operation of the safety outputs. . . . . 5

5.2 Coding . . . . . 5

**6 Diagnostic functions**

6.1 Operating principle of the diagnostic LED's . . . . . 6

6.2 Operating principle of the electronic diagnostic output . . . . . 6

6.3 Safety-sensors with serial diagnostic function . . . . . 7

**7 Set-up and maintenance**

7.1 Functional testing. . . . . 8

7.2 Maintenance . . . . . 8

**8 Disassembly and disposal**

8.1 Disassembly. . . . . 8

8.2 Disposal . . . . . 8

**9 Appendix**

9.1 Wiring configuration and connector accessories . . . . . 8

9.2 Wiring examples . . . . . 9

**10 EU Declaration of conformity**

**1. About this document**

**1.1 Function**

This operating instructions manual provides all the information you need for the mounting, set-up and commissioning to ensure the safe operation and disassembly of the safety switchgear. The operating instructions must be available in a legible condition and a complete version in the vicinity of the device.

**1.2 Target group: authorised qualified personnel**

All operations described in this operating instructions manual must be carried out by trained specialist personnel, authorised by the plant operator only.

Please make sure that you have read and understood these operating instructions and that you know all applicable legislations regarding occupational safety and accident prevention prior to installation and putting the component into operation.

The machine builder must carefully select the harmonised standards to be complied with as well as other technical specifications for the selection, mounting and integration of the components.

**1.3 Explanation of the symbols used**

 **Information, hint, note:**  
This symbol is used for identifying useful additional information.

 **Caution:** Failure to comply with this warning notice could lead to failures or malfunctions.  
**Warning:** Failure to comply with this warning notice could lead to physical injury and/or damage to the machine.

**1.4 Appropriate use**

The products described in these operating instructions are developed to execute safety-related functions as part of an entire plant or machine. It is the responsibility of the manufacturer of a machine or plant to ensure the correct functionality of the entire machine or plant.

The safety switchgear must be exclusively used in accordance with the versions listed below or for the applications authorised by the manufacturer. Detailed information regarding the range of applications can be found in the chapter "Product description".

**1.5 General safety instructions**

The user must observe the safety instructions in this operating instructions manual, labelled with the caution or warning symbol above, the country-specific installation standards as well as all prevailing safety regulations and accident prevention rules.

 Further technical information can be found in the Schmersal catalogues or in the online catalogue on the Internet: [www.schmersal.net](http://www.schmersal.net).

The information contained in this operating instructions manual is provided without liability and is subject to technical modifications.

There are no residual risks, provided that the safety instructions as well as the instructions regarding mounting, commissioning, operation and maintenance are observed.

### 1.6 Warning about misuse



In case of improper use or manipulation of the safety switchgear, personal hazards or damages to machinery or plant components cannot be excluded when safety switchgear is used. The relevant requirements of the standard ISO 14119 must be observed.

### 1.7 Exclusion of liability

We shall accept no liability for damages and malfunctions resulting from defective mounting or failure to comply with this operating instructions manual. The manufacturer shall accept no liability for damages resulting from the use of unauthorised spare parts or accessories.

For safety reasons, invasive work on the device as well as arbitrary repairs, conversions and modifications to the device are strictly forbidden; the manufacturer shall accept no liability for damages resulting from such invasive work, arbitrary repairs, conversions and/or modifications to the device.

## 2. Product description

### 2.1 Ordering code

This operating instructions manual applies to the following types:

#### RSS 36 ①-②-③-④

No.	Option	Description
①		Standard coding
	I1	Individual coding
②	I2	Individual coding, re-teaching enabled
	D	With diagnostic output
③	SD	With serial diagnostic function
		Without latching
④	R	With latching, latching force approx. 18 N
	ST	With connecting cable 2 m
		With connector plug M 12

#### Actuator

RST 36-1	Without latching
RST 36-1-R	With latching, latching force approx. 18 N

### 2.2 Special versions

For special versions, which are not listed in the order code below 2.1, these specifications apply accordingly, provided that they correspond to the standard version.

### 2.3 Comprehensive quality insurance to 2006/42/EC

Schmersal is a certified company to appendix X of the Machinery Directive. As a result, Schmersal is entitled to autonomously conduct the conformity assessment procedure for the products listed in Appendix IV of the MD without involving a notified body. The prototype test certificates are available upon request or can be downloaded from the Internet at [www.schmersal.com](http://www.schmersal.com).

### 2.4 Destination and use

This non-contact, electronic safety sensor is designed for application in safety circuits and is used for monitoring the position of movable safety guards. In this application, the safety sensor monitors the position of hinged, sliding or removable safety guards by means of the coded electronic actuator.

The safety function consists of safely switching off the safety outputs when the safety guard is opened and maintaining the safe switched off condition of the safety outputs for as long as the safety guard is open.



The safety switchgears are classified according to ISO 14119 as type 4 switching devices. Designs with individual coding are classified as highly coded.

Safety sensors and actuators with latching (ordering suffix 'R') must always be used in pairs. The latching force (approx. 18 N) exercised by the permanent magnet keeps hatches and small guards closed, also in a de-energised condition.

The system can be used as a door end stop up to 5 kg at 0.25 m/s.

The diagnostic output of the safety sensor alternatively can be used as a conventional output or as a "serial output" with input and output channel.

### Series-wiring

Series-wiring can be set up. The response and risk times are not altered by wiring in series. The number of components is only limited by the external cable protection according to the technical data and the line loss. Series-wiring of up to 31 RSS 36 ... SD components with serial diagnostics is possible.

In devices with the serial diagnostics function (ordering suffix -SD), the serial diagnostics connections are wired in series and connected to a SD Gateway for evaluation purposes. (Wiring examples: see appendix.)



The user must evaluate and design the safety chain in accordance with the relevant standards and the required safety level. If multiple safety switchgears are involved in the same safety function, the PFH values of the individual components must be added.



The entire concept of the control system, in which the safety component is integrated, must be validated to the relevant standards.

### 2.5 Technical data

Standards:	IEC 60947-5-3, ISO 13849-1, IEC 61508, IEC 62061
Enclosure:	glass-fibre reinforced thermoplastic, self-extinguishing
Operating principle:	RFID
Coding level according to ISO 14119:	
- I1-version:	high
- I2-version:	high
- Standard coding version:	low
Actuator:	RST 36-1, RST 36-1-R
Series-wiring:	Unlimited number of components, please observe external cable protection, max. 31 components in case of serial diagnostics
Termination:	connector plug M12 or cable
Connector plug:	M12, 8-pole, A-coded
Pre-wired cable:	Y-UL 2517 / 8 × AWG 22 / 8 × 0.35 mm <sup>2</sup> , 2 m

#### Temperature resistance of the cable:

- at rest:	-30 °C ... +105 °C
- in motion:	-10 °C ... +105 °C
Cable length	max. 30 m
	(cable length and cable section alter the voltage drop depending on the output current)

#### Switching distances to IEC 60947-5-3:

Rated switching distance $s_n$ :	12 mm
assured switching distance $s_{ao}$ :	10 mm
assured switch-off distance $s_{ar}$ :	16 mm
Hysteresis:	< 2.0 mm
Repeat accuracy R:	< 0.5 mm

#### Ambient conditions:

Ambient temperature:	-25 °C ... +70 °C
Storage and transport temperature:	-25 °C ... +85 °C
Protection class:	IP65 / IP67 to IEC 60529,
- Version with connector:	IP69K to DIN 40050-9
Resistance to vibration:	10 ... 55 Hz, Amplitude 1 mm
Resistance to shock:	30 g / 11 ms
Switching frequency f:	1 Hz
Response time:	≤ 100 ms
Duration of risk:	≤ 200 ms
Time to readiness:	≤ 2 s

#### Electrical data:

Rated operating voltage $U_e$ :	24 VDC -15% / +10% (PELV to IEC 60204-1)
Rated operating current $I_e$ :	0.6 A
Minimum operating current $I_m$ :	0.5 mA
Required rated short-circuit current:	100 A
Rated insulation voltage $U_i$ :	32 V
Rated impulse withstand voltage $U_{imp}$ :	800 V
No-load current $I_o$ :	35 mA
Residual current $I_r$ :	< 0.5 mA
Protection class:	II
Overvoltage category:	III
Degree of pollution:	3

#### Safety inputs X1/X2:

Rated operating voltage $U_{e1}$ :	24 VDC -15% / +10% (PELV unit)
Power consumption per input:	5 mA

#### Safety outputs Y1/Y2:

	p-type, short-circuit proof
Operating current $I_{e1}$ :	max. 0,25 A
Utilisation category:	DC-12 $U_e/I_e$ 24 VDC / 0.25 A DC-13 $U_e/I_e$ 24 VDC / 0.25 A

Voltage drop:	$U_e < 1$ V
---------------	-------------

#### Diagnostic output:

	short-circuit proof, p-type
Operating current $I_{e2}$ :	max. 0,05 A
Utilisation category:	DC-12 $U_e/I_e$ 24 VDC / 0.05 A DC-13 $U_e/I_e$ 24 VDC / 0.05 A

Voltage drop:	$U_e < 2$ V
---------------	-------------

#### Serial diagnostic:

	short-circuit proof
Operating current:	150 mA
Wiring capacitance:	max. 50 nF
External cable protection:	fuse
-Version with connector:	2.0 A
-Version with cable:	4.0 A

Please observe the cable section

### 2.6 Safety classification

Standards:	ISO 13849-1, IEC 61508, IEC 62061
PL:	e
Control Category:	4
PFH value:	$2.7 \times 10^{-10}$ / h
PFD:	$2.1 \times 10^{-5}$
SIL:	suitable for SIL 3 applications
Service life:	20 years

## 3. Mounting

### 3.1 General mounting instructions



During fitting, the requirements of ISO 14119 must be observed.

Ensure the safety sensor is mounted on a flat surface. The universal mounting holes provide for a variable mounting by means of M4 screws (tightening torque 2.5 Nm). The component can be mounted in any position. The labelled surfaces of the safety sensor and the actuator have to be opposite. The safety sensor must only be used within the assured switching distances  $\leq s_{ao}$  and  $\geq s_{ar}$ .



The safety component and the actuator must be permanently fitted to the safety guards and protected against displacement by suitable measures (tamperproof screws, gluing, drilling, pinning).

To avoid any interference inherent to this kind of system and any reduction of the switching distances, please observe the following guidelines:

- The presence of metal chips in the vicinity of the sensor is liable to modify the switching distance.
- Keep away from metal chips.
- Minimum distance between two sensors: 100 mm

#### Accessories (to be ordered separately)

##### Kit tamper-proof screws

- 4 x M4x25 incl. washers, ordering code 101217746
- 4 x M4x30 incl. washers, ordering code 101217747

##### Sealing kit

- Ordering code 101215048
- 8 plugs and 4 washers
- to seal the mounting holes and as spacer (approx. 3 mm) to facilitate the cleaning below the mounting surface
- also suitable as tampering protection for the screw fixings.

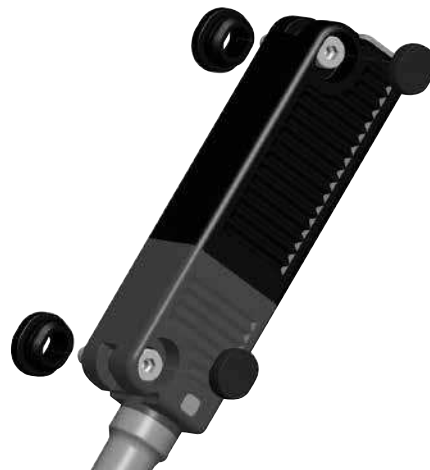

### 3.2 Dimensions

All measurements in mm.

Safety sensor RSS 36 ST

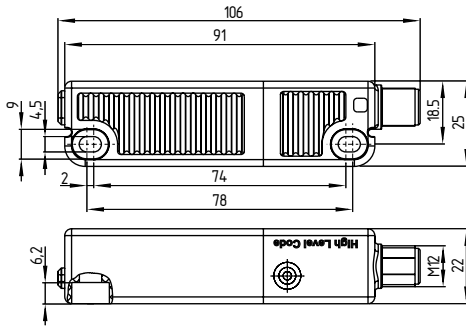

Actuator RST 36-1 / RST 36-1-R

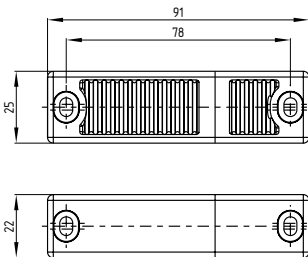

**i** Alternative suitable actuators with different design: refer to [www.schmersal.net](http://www.schmersal.net).

### 3.3 Switching distance

The side allows for a maximum height misalignment (X) of sensor and actuator of  $\pm 8$  mm (e.g. mounting tolerance or due to guard door sagging). The axial misalignment (y) is max.  $\pm 18$  mm.

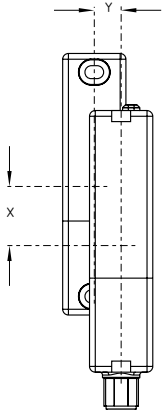

**i** Latching versions  $X \pm 5$  mm,  $Y \pm 3$  mm. The latching force will be reduced by misalignment.

### Actuating curves

The actuating curves represent the typical switching distance of the safety sensor during the approach of the actuator subject to the actuating direction

#### Transverse misalignment

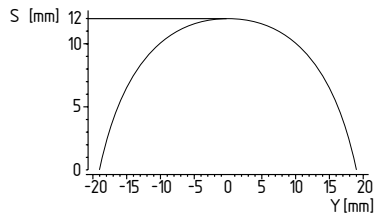

#### Height misalignment

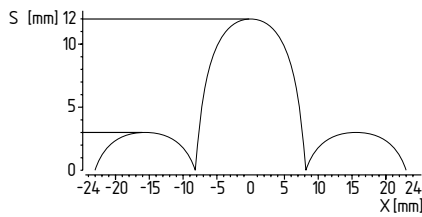

**i** Preferred actuation directions: from front or from side

### 3.4 Adjustment

The continuous signal of the yellow LED signals the actuator detection; the flashing of the yellow LED signals that the safety sensor is actuated in the hysteresis area.

**i** **Recommended Adjustment**  
Align the safety sensor and actuator at a distance of  $0.5 \times s_{a0}$ .

The correct functionality of both safety channels must be checked by means of the connected safety-monitoring module.

## 4. Electrical connection

### 4.1 General information for electrical connection

**!** The electrical connection may only be carried out by authorised personnel in a de-energised condition.

The safety outputs can be integrated into the safety circuit of the control system. For applications of PL e / control category 4 to ISO 13849-1, the safety outputs of the safety sensor or sensor of the chain must be wired to a safety monitoring module of the same control category .

Protection is not required when pilot wires are laid. The cables however must be separated from the supply and energy cables. The max. fuse rate for a sensor chain depends on the section of the connecting cable of the sensor.

#### Requirements for the connected safety-monitoring module

- Dual-channel safety input, suitable for p-type sensors with NO function

**i** Information for the selection of suitable safety-monitoring modules can be found in the Schmersal catalogues or in the online catalogue on the Internet: [www.schmersal.net](http://www.schmersal.net).

As an alternative to a safety-monitoring module, the safety sensors of the CSS 34F0 or CSS 34F1 series can also be used as first sensor of a series-wired chain for the direct control and monitoring of safety contactors (refer to operating manual of CSS 34F0 / CSS 34F1).

If the safety sensor is wired to relays or to non-safety relevant control components, a new risk analysis must be carried out.

The sensors cyclically switch off the safety output to test them. The safe switch-off times must be tolerated by the safety-monitoring module. The switch-off time of the safety sensor is additionally extended depending on the cable length and the capacity of the cable used. Typically, a switch-off time of 250 µs is reached with a 30-m connecting cable.



### Configuration of the safety-monitoring module

When connecting the safety sensor to an electronic safety evaluation unit we recommend setting a discrepancy time of 100 ms. The safety inputs of the evaluation should be able to mute a test impulse of approx. 1 ms.

## 4.2 Serial diagnostic -SD

### Cable design in case of serial diagnostics



When wiring SD devices, please observe the voltage drop on the cables and the current carrying capacity of the individual components.

The wiring capacitance of the connecting cable of the safety sensor must not exceed 50 nF.

Depending on the strand structure, normal unshielded 30 m long control cables LIYY 0.25 mm<sup>2</sup> to 1.5 mm<sup>2</sup> have a wiring capacitance of approx. 3 ... 7 nF.



### Accessories SD interface

For ease of wiring and series-wiring of SD devices considerable accessories are available. Detailed information is available on the Internet, [www.schmersal.net](http://www.schmersal.net).

## 5. Operating principles and coding

### 5.1 Mode of operation of the safety outputs

The safety outputs can be integrated into the safety circuit of the control system. The opening of a safety guard, i.e. the actuator is removed out of the active zone of the sensor, will immediately disable the safety outputs of the sensor (switching distances refer to technical data).

Any error that does not immediately affect the functionality of the safety sensor (e.g. too high the ambient temperature, interference potential at a safety output, cross-wire short) will lead to a warning message, the disabling of the diagnostic output and the delayed shut-down of the safety outputs. safety outputs are disabled if the error warning is active for 30 minutes.

The signal combination, diagnostic output disabled and safety channels still enabled, can be used to stop the production process in a controlled manner.

After fault rectification, the error message is reset by opening and re-closing the corresponding safety guard. The safety outputs enable and allow a restart.

For devices with serial diagnostic, a bit can be set/deleted in the call telegram to reset the fault.

### 5.2 Coding

Safety sensors with standard coding are ready to use upon delivery.

Individually coded safety sensors and actuators will require the following "teach-in" procedure:

1. Energise the safety sensor.
2. Introduce the actuator in the detection range. The teach-in procedure is signalled at the safety sensor, red LED on, yellow LED flashes (1 Hz).
3. After 10 seconds, brief cyclic flashes (3 Hz) request the switch-off of the operating voltage of the safety sensor. (If the voltage is not switched off within 5 minutes, the safety sensor cancels the "teach-in" procedure and signals a false actuator by 5 red flashes).
4. After the operating voltage is switched back on, the actuator must be detected once more in order to activate the taught actuator code. In this way, the activated code is definitively saved!

For ordering suffix -I1, the thus executed allocation of safety sensor and actuator is irreversible.

For ordering suffix -I2, the "teach-in" procedure for a new actuator can be repeated an unlimited number of times. When a new actuator is taught, the code, which was applicable until that moment, becomes invalid. Subsequent to that, an enabling inhibit will be active for ten minutes, thus providing for an increased protection against tampering. The green LED will flash until the expiration of the time of the enabling inhibit (time of the tampering protection) and the detection of the new actuator. In case of power failure during the lapse of time, the 10-minutes tampering protection time will restart.

6. Diagnostic functions







6.1 Operating principle of the diagnostic LED's

The safety sensor indicates the operating condition and faults by means of three-colour LED's located in the lateral surfaces of the sensor.

The green LED indicates that the safety sensor is ready for operation. The supply voltage is on. The yellow LED always signals the presence of an actuator within range. If the actuator is operating near the limit of the hysteresis range of the safety sensor, the LED is flashing.

The flashing can be used to prematurely detect variations in the clearance between the sensor and the actuator (e.g. sagging of a safety guard). The sensor must be adjusted before the distance to the actuator increases and before the safety outputs are disabled, thus stopping the machine. If an error is detected, the red LED will be activated.

Flash codes red diagnostic LED

LED indication (red)	Error cause
1 flash pulse 	Error output Y1
2 flash pulses 	Error output Y2
3 flash pulses 	Cross-wire Y1/Y2
4 flash pulses 	ambient temperature too high
5 flash pulses 	Wrong or defective actuator
Continuous red 	Internal fault, with yellow flashing teaching procedure

6.2 Operating principle of the electronic diagnostic output

A diagnostic output additionally indicates the operating condition (refer to table 1). These signals can be used in a downstream control.

The short-circuit proof diagnostic output OUT can be used for central visualisation or control functions, e.g. in a PLC. It indicates the switching condition as shown in the table 1.

Error

Errors, which no longer guarantee the function of the safety sensor (internal errors) cause the safety outputs to be disabled within the risk time. Any error that does not immediately affect the safe functionality of the safety sensor (e.g. the ambient temperature too high, interference potential at a safety output, cross-wire short) will lead to a delayed shut-down (refer to table 2).

After the rectification of the error, the error message is reset by opening the corresponding safety guard.

Error warning

The diagnostic output can also be used to detect clearance variations between the sensor and the actuator in the same way as the yellow LED. An active fault causes the diagnostic output to be disabled. The safety outputs are disabled after max. 30 minutes if the fault is not rectified. This signal combination, diagnostic output disabled and safety channels still enabled, can be used to stop the production process in a controlled manner.

Table 1: Examples of the diagnostic function of the safety-sensor with conventional diagnostic output

Sensor function		LED's			Diagnostic output	Safety outputs Y1, Y2	Note
		Green	Red	Yellow			
I.	Supply voltage	On	Off	Off	0 V	0 V	Voltage on, no evaluation of the voltage quality
II.	actuated	Off	Off	On	24 V	24 V	The yellow LED always signals the presence of an actuator within range
III.	Actuated in limit area	Off	Off	Flashes (1Hz)	24 V pulsed	24 V	The sensor must be adjusted before the distance to the actuator increases and before the safety outputs are disabled, thus stopping the machine
IV.	Error warning, sensor actuated	Off	Flashes	Off	0 V	24 V	After 30 minutes if the error is not rectified
V.	Error	Off	Flashes	Off	0 V	0 V	Refer to table with flash codes
VI.	Teach actuator	Off	On	Flashes	0 V	0 V	Sensor in teaching mode
VII.	Protection time	Flashes	Off	Off	0 V	0 V	10 minutes pause after re-teaching

**6.3 Safety-sensors with serial diagnostic function**

Safety sensors with serial diagnostic cable have a serial input and output instead of the conventional diagnostic output. If RSS / CSS safety sensors are wired in series, the safety channels as well as the inputs and outputs of the diagnostic channels are wired in series.

Max. 31 safety switchgear with serial diagnostics can be wired in series. For the evaluation of the serial diagnostics line either the PROFIBUS-Gateway SD-I-DP-V0-2 or the Universal-Gateway SD-I-U-... are used. This SD-Gateway is integrated as a slave in an existing field bus system. In this way, the diagnostic signals can be evaluated by means of a PLC. The necessary documentation for the integration of the SD-Gateway is available for download at [www.schmersal.com](http://www.schmersal.com).

The response data and the diagnostic data are automatically and permanently written in the assigned input byte of the PLC for each safety sensor in the series-wired chain.

The request data for each safety sensor are transmitted to the device through an output byte of the PLC.

In the event of a communication error between the SD-Gateway and the safety sensor, the switching condition of the safety output of the safety sensor is maintained.

- Bit 0: safety outputs enabled
- Bit 1: safety sensor actuated, actuator identified
- Bit 4: both safety inputs live
- Bit 5: safety sensor actuated in hysteresis area
- Bit 6: error warning, switch-off delay activated
- Bit 7: error, safety outputs switched off

**Error**

A fault has occurred, which causes the safety outputs to be disabled. The fault is reset, when the cause is eliminated and bit 7 of the request byte changes from 1 to 0 or the safety guard is opened. Faults at the safety outputs are only deleted upon the next release, as the fault rectification cannot be detected sooner.

**Error warning**

A fault has occurred, which causes the safety outputs to be disabled after 30 minutes. The safety outputs initially remain enabled. This enables the shutdown of the process in a controlled manner. An error warning is deleted when the error cause is eliminated.

**Diagnostic error (warning)**

If an error (warning) is signalled in the response byte, detailed fault information can be read out.

Detailed information about the use of the serial diagnostics can be found in the operating instructions of the PROFIBUS-Gateway SD-I-DP-V0-2 and the Universal-Gateway SD-I-U-....

**Table 2: Function of the visual diagnostic LED's, the serial status signals and the safety outputs by means of an example**

System condition	LED's			Safety outputs Y1, Y2	Status signals serial diagnostic byte Bit n°								
	green	red	yellow		7	6	5	4	3	2	1	0	
Non-actuated, inputs X1 and X2 enabled	On	Off	Off	0 V	0	0	0	1	0	0	0	0	0
Actuated, safety outputs enabled	Off	Off	On	24 V	0	0	0	1	0	0	1	1	1
Actuated in limit area	Off	Off	Flashes (1Hz)	24 V	0	0	1	1	0	0	1	1	1
Actuated, warning	Off	On/flashes	Off	24 V	0	1	0	1	0	0	1	1	1
Actuated, fault	Off	On/flashes	Off	0 V	1	1	0	1	0	0	1	1	0

The shown bit order of the diagnostic byte is an example. A different combination of the operational conditions will lead to a change of the bit order.

**Table 3: Tabular overview of status signals, warnings or error messages**

Communication directions: Request byte: from the PLC to the local safety sensor  
 Response byte: from the local safety sensor to the PLC  
 Warning/error byte: from the local safety sensor to the PLC

Bit n°	Request byte	Response byte	Diagnostic Error warnings	Error messages
Bit 0:	—	Safety output activated	Error output Y1	Error output Y1
Bit 1:	—	Actuator detected	Error output Y2	Error output Y2
Bit 2:	—	—	Cross-wire Y1/Y2	Cross-wire Y1/Y2
Bit 3:	—	—	Temperature too high	Temperature too high
Bit 4:	—	Input condition X1 and X2	—	Wrong or defective actuator
Bit 5:	—	Actuated in limit area	Internal device error	Internal device error
Bit 6:	—	Error warning	Communication error between the field bus Gateway and the safety sensor	—
Bit 7:	Error reset	Error (enabling path switched off)	—	—

The described condition is reached, when Bit = 1

### 7. Set-up and maintenance

#### 7.1 Functional testing

The safety function of the safety components must be tested. The following conditions must be previously checked and met:

1. Fitting of the sensor and the actuator.
2. Fitting and integrity of the power cable.
3. The system is free of dirt and soiling (in particular metal chips).

#### 7.2 Maintenance

In the case of correct installation and adequate use, the safety sensor features maintenance-free functionality.

A regular visual inspection and functional test, including the following steps, is recommended:

1. Check the fitting and integrity of the safety sensor, the actuator and the cable.
2. Remove possible metal chips.



Adequate measures must be taken to ensure protection against tampering either to prevent tampering of the safety guard, for instance by means of replacement actuators.

**Damaged or defective components must be replaced.**

### 8. Disassembly and disposal

#### 8.1 Disassembly

The safety switchgear must be disassembled in a de-energised condition only.

#### 8.2 Disposal

The safety switchgear must be disposed of in an appropriate manner in accordance with the national prescriptions and legislations.

### 9. Appendix

#### 9.1 Wiring configuration and connector accessories

Function safety switchgear		Pin configuration of the connector	Colour code of the integrated cable or the Schmersal connector	Possible colour codes of other conventional connectors	
with conventional diagnostic output	with serial diagnostic function			to IEC 60947-5-2: 2007	to DIN 47100
<b>A1</b>	U <sub>e</sub>		1	BN	WH
<b>X1</b>	Safety input 1		2	WH	BN
<b>A2</b>	GND		3	BU	GN
<b>Y1</b>	Safety output 1		4	BK	YE
<b>OUT</b>	Diagnostic output	SD output	5	GY	GY
<b>X2</b>	Safety input 2		6	VT	PK
<b>Y2</b>	Safety output 2		7	RD	BU
<b>IN</b>	without function	SD input	8	PK	or RD

#### Connector plug ST M12, 8-pole



#### Connecting cables with coupling (female) IP67, M12, 8-pole - 8 x 0.23 mm<sup>2</sup>

Cable length	Part number
2.5 m	101209963
5.0 m	101209964
10.0 m	101209960

#### Connecting cables with coupling (female) IP69K, M12, 8-pole - 8 x 0.21 mm<sup>2</sup>

Cable length	Part number
5.0 m	101210560
5.0 m	101210561 (angled)



**9.2 Wiring examples**

The application examples shown are suggestions. They however do not release the user from carefully checking whether the switchgear and its set-up are suitable for the individual application.

**Wiring example 1:**  
**Series-wiring of the RSS 36 with conventional diagnostic output**

The voltage is supplied to both safety inputs of the last safety sensor of the chain (considered from the safety-monitoring module). The safety outputs of the first safety sensor are wired to the safety-monitoring module. The diagnostic output can be connected for instance to a PLC.

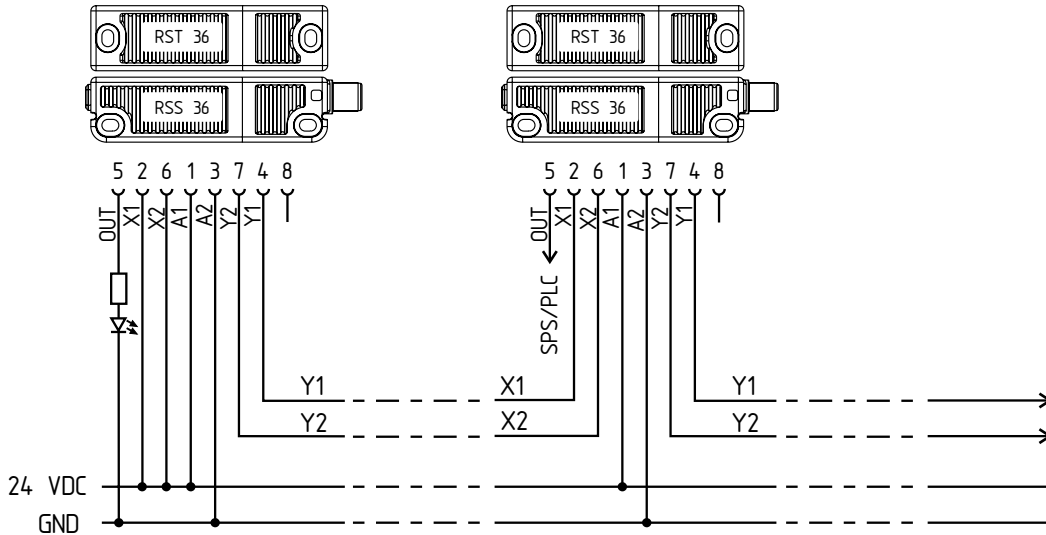

Y1 and Y2 = Safety outputs → Safety monitoring module

**Wiring example 2:**  
**Series-wiring of the RSS 36 with serial diagnostic function**

The voltage is supplied to both safety inputs of the last safety sensor of the chain (considered from the safety-monitoring module). The safety outputs of the first safety sensor are wired to the safety-monitoring module. The serial Diagnostic Gateway is connected to the serial diagnostic input of the first safety sensor.

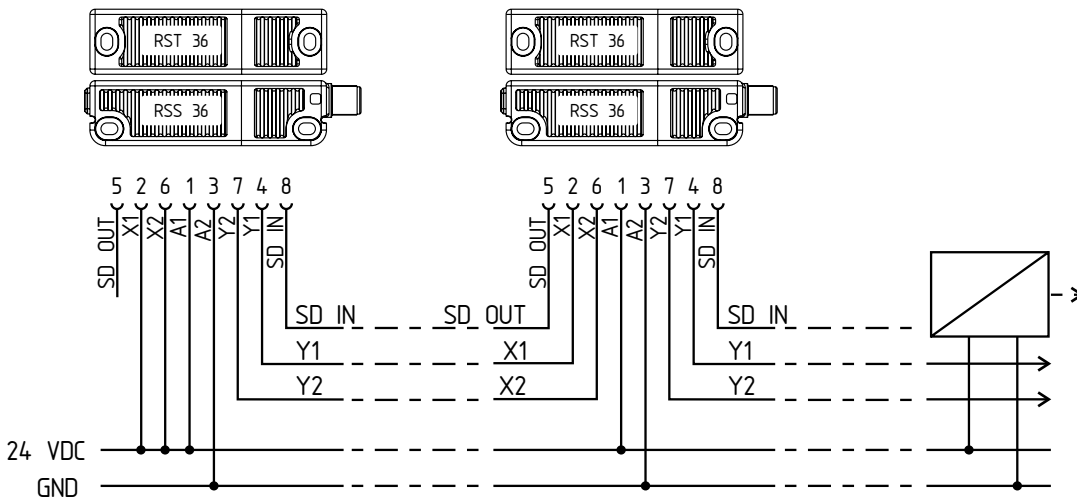

Y1 and Y2 = Safety outputs → Safety monitoring module  
 SD-IN → Gateway → Field bus

10. EU Declaration of conformity

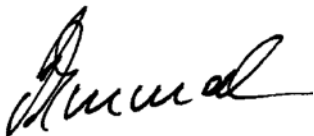
EU Declaration of conformity			
Original	K.A. Schmersal GmbH & Co. KG Möddinghofe 30 42279 Wuppertal Germany Internet: www.schmersal.com		
We hereby certify that the hereafter described components both in their basic design and construction conform to the applicable European Directives.			
<b>Name of the component:</b>	RSS 36		
<b>Type:</b>	See ordering code		
<b>Description of the component:</b>	Non-contact safety sensor		
<b>Relevant Directives:</b>	Valid up to	Valid as of	
	April 19, 2016	<sup>1)</sup> April 20, 2016 <sup>2)</sup> June 13, 2016	
	Machinery Directive	2006/42/EC	2006/42/EC <sup>1)</sup>
	EMC-Directive	2004/108/EC	2014/30/EU <sup>1)</sup>
	R&TTE- / RED-Directive	1999/5/EC	2014/53/EU <sup>2)</sup>
	RoHS-Directive	2011/65/EU	2011/65/EU <sup>1)</sup>
<b>Applied standards:</b>	EN 60947-5-3:2013, ISO 14119:2013, EN ISO 13849-1:2008 + AC:2009, IEC 61508 parts 1-7:2010, EN 62061:2005 + AC:2010 + A1:2013		
<b>Notified body for the prototype test:</b>	TÜV Rheinland Industrie Service GmbH Alboinstraße 56 12103 Berlin ID n°: 0035		
<b>EC-prototype test certificate:</b>	01/205/5115.01/15		
<b>Person authorized for the compilation of the technical documentation:</b>	Oliver Wacker Möddinghofe 30 42279 Wuppertal		
<b>Place and date of issue:</b>	Wuppertal, April 7, 2016		
			
	Authorised signature <b>Philip Schmersal</b> Managing Director		

RSS36-D-EN



The currently valid declaration of conformity can be downloaded from the internet at [www.schmersal.net](http://www.schmersal.net).



**K. A. Schmersal GmbH & Co. KG**  
Möddinghofe 30, D - 42279 Wuppertal  
Postfach 24 02 63, D - 42232 Wuppertal

Phone: +49 - (0)2 02 - 64 74 - 0  
Telefax: +49 - (0)2 02 - 64 74 - 1 00  
E-Mail: [info@schmersal.com](mailto:info@schmersal.com)  
Internet: <http://www.schmersal.com>