



EN Operating instructions.pages 1 to 6
Translation of the original operating instructions

Content

1 About this document

1.1 Function 1

1.2 Target group: authorised qualified personnel. 1

1.3 Explanation of the symbols used 1

1.4 Appropriate use 1

1.5 General safety instructions 1

1.6 Warning about misuse 1

1.7 Exclusion of liability 2

2 Product description

2.1 Ordering code 2

2.2 Special versions. 2

2.3 Destination and use 2

2.4 Technical data 2

2.5 Safety classification 2

3 Mounting

3.1 General mounting instructions 3

3.2 Dimensions 3

4 Electrical connection

4.1 General information for electrical connection. 3

4.2 Contact variants. 4

4.3 Switch travel. 4

4.4 Door gap calculation 5

5 Set-up and maintenance

5.1 Functional testing. 5

5.2 Maintenance 5

6 Disassembly and disposal

6.1 Disassembly. 5

6.2 Disposal 5

7 Appendix

7.1 EC Declaration of conformity 6

1. About this document

1.1 Function

This operating instructions manual provides all the information you need for the mounting, set-up and commissioning to ensure the safe operation and disassembly of the safety switchgear. The operating instructions must be available in a legible condition and a complete version in the vicinity of the device.

1.2 Target group: authorised qualified personnel

All operations described in this operating instructions manual must be carried out by trained specialist personnel, authorised by the plant operator only.

Please make sure that you have read and understood these operating instructions and that you know all applicable legislations regarding occupational safety and accident prevention prior to installation and putting the component into operation.

The machine builder must carefully select the harmonised standards to be complied with as well as other technical specifications for the selection, mounting and integration of the components.

1.3 Explanation of the symbols used



Information, hint, note:

This symbol is used for identifying useful additional information.



Caution: Failure to comply with this warning notice could lead to failures or malfunctions.

Warning: Failure to comply with this warning notice could lead to physical injury and/or damage to the machine.

1.4 Appropriate use

The products described in these operating instructions are developed to execute safety-related functions as part of an entire plant or machine. It is the responsibility of the manufacturer of a machine or plant to ensure the correct functionality of the entire machine or plant.

The safety switchgear must be exclusively used in accordance with the versions listed below or for the applications authorised by the manufacturer. Detailed information regarding the range of applications can be found in the chapter "Product description".

1.5 General safety instructions

The user must observe the safety instructions in this operating instructions manual, the country-specific installation standards as well as all prevailing safety regulations and accident prevention rules.



Further technical information can be found in the Schmersal catalogues or in the online catalogue on the Internet: www.schmersal.net.

The information contained in this operating instructions manual is provided without liability and is subject to technical modifications.

There are no residual risks, provided that the safety instructions as well as the instructions regarding mounting, commissioning, operation and maintenance are observed.

1.6 Warning about misuse



In case of improper use or manipulation of the safety switchgear, personal hazards or damages to machinery or plant components cannot be excluded when safety switchgear is used. The relevant requirements of the standard ISO 14119 must be observed.

1.7 Exclusion of liability

We shall accept no liability for damages and malfunctions resulting from defective mounting or failure to comply with this operating instructions manual. The manufacturer shall accept no liability for damages resulting from the use of unauthorised spare parts or accessories.

For safety reasons, invasive work on the device as well as arbitrary repairs, conversions and modifications to the device are strictly forbidden; the manufacturer shall accept no liability for damages resulting from such invasive work, arbitrary repairs, conversions and/or modifications to the device.

2. Product description

2.1 Ordering code

This operating instructions manual applies to the following types:

TESF ①/②/③/④/⑤

No.	Option	Description
①	A	Without end stop With end stop
②	S	With additional hinge Without additional hinge
③	CC ST24	Screw connection Cage clamps 24V connector
④	.1 .2	Bottom-side connector Top-side connector
⑤	0 180 U	Preset for front assembly Preset for inside assembly Adjustable on site

2.2 Special versions

For special versions, which are not listed in the order code below 2.1, these specifications apply accordingly, provided that they correspond to the standard version.

2.3 Destination and use

The TESF hinge safety switch has been designed to prevent, in conjunction with the control part of a machine, movable safety guards from being opened before hazardous conditions have been eliminated. They are also suitable for fitting on profile sections and existing equipment.



Hinge safety switches can only be used for applications, in which the hazardous condition is terminated without delay (e.g. run-on movements) when the safety guard is opened.



The user must evaluate and design the safety chain in accordance with the relevant standards and on the required safety level.



The entire concept of the control system, in which the safety component is integrated, must be validated to the relevant standards.

2.4 Technical data

Standards:	IEC 60947-5-1; BG-GS-ET-15
Enclosure:	Zinc diecast, enclosure cover self-extinguishing thermoplastic
Hinge bolt:	Stainless steel 1.4305
Contact material:	Silver, gold-plated
Protection class:	IP65
Contact type:	Change-over contact with double break Zb
Switching system:	⊖ IEC 60947-5-1; slow action, NC contact with positive break

Connection:	Screw terminals, cage clamps, connector
Cable type:	solid wire
Cable section:	
- Screw terminals:	min. 0.14 mm ² , max. 1.5 mm ²
- Cage clamps:	min. 0.25 mm ² , max. 1 mm ²
Cable type:	stranded wire
Cable section:	
- Screw terminals:	min. 0.25 mm ² , max. 1 mm ² , with conductor ferrules,
- Cage clamps:	min. 0.25 mm ² , max. 0.75 mm ² with conductor ferrules
Cable entry:	2 x M16
Positive break angle:	10°
Actuating speed:	max. 180°/0.3 s
Actuating frequency:	max. 1200 operations/h
Mechanical life:	> 1 million operations
Ambient temperature:	-25 °C ... +65 °C
Utilisation category:	AC-15, DC-13
Rated operating current/voltage I _g /U _e :	2 A / 230 VAC; 1 A / 24 VDC
Rated insulation voltage U _i :	250 V,
- Connector ST24:	36 V
Rated impulse withstand voltage U _{imp} :	2.5 kV,
- Connector ST24:	0.8 kV
Thermal test current I _{the} :	2.5 A
Max. rated operating voltage U _{e max} :	24 VDC 230 VAC
- Connector ST24:	24 VAC
Max. fuse rating:	2 A gG D-fuse
Required short-circuit current:	1000 A
Switching of low voltages:	1 mA / 5 VDC
Mechanical data (see Fig.):	
- F1:	5000 N
- F2:	5000 N
- F3:	1900 N
- F4:	800 N

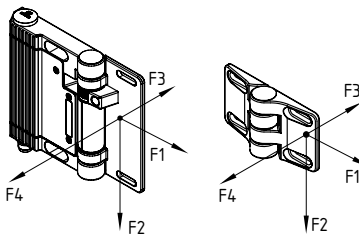

2.5 Safety classification

Standards:	ISO 13849-1
Envisaged structure:	
- Basically:	applicable up to Cat. 1 / PL c
- With 2-channel usage and fault exclusion mechanism*:	applicable up to Cat. 3 / PL d with suitable logic unit
B _{10d} NC contact:	2,000,000
B _{10d} NO contact at 10% ohmic contact load:	1,000,000
Service life:	20 years

* If a fault exclusion to the 1-channel mechanics is authorised.

$$MTTF_d = \frac{B_{10d}}{0,1 \times n_{op}} \quad n_{op} = \frac{d_{op} \times h_{op} \times 3600 \text{ s/h}}{t_{cycle}}$$

(Determined values can vary depending on the application-specific parameters h_{op} , d_{op} and t_{cycle} as well as the load.)

If multiple safety components are wired in series, the Performance Level to ISO 13849-1 will be reduced due to the restricted error detection under certain circumstances.

3. Mounting

3.1 General mounting instructions



During fitting of the actuator and the sensor, the requirements of ISO 14119, especially paragraph 7 must be observed!

Four mounting holes are provided for fixing the switch. When used in applications with function for the protection of man, the components must be fitted so that disassembly is prevented (e.g. drill out the hexagonal recess of the fixing screws, blocking the hexagonal recess using a plastic cone diameter 5.1 mm). The hinge switch furthermore must be pinned after assembly and adjustment (Fig. 1). The hinge safety switch must not be used as an end stop. Any mounting position. The mounting position however is chosen so that the components are preferably fitted in the upper part of the safety guard to avoid the ingress of dirt and soiling as well as damage to the components. In case of painting activities, the components must be covered. The supplied fixing material must be used. We recommend that the fixing screws are painted after the component is fitted.

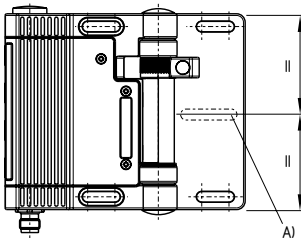

Fig. 1

Legend:

A = Drill and pin in this area



Please observe the remarks of the standards ISO 12100, EN 953 and ISO 14119. Also observe the safety distances to the standards ISO 13857 and EN 349.

3.2 Dimensions

All measurements in mm.

TESFA

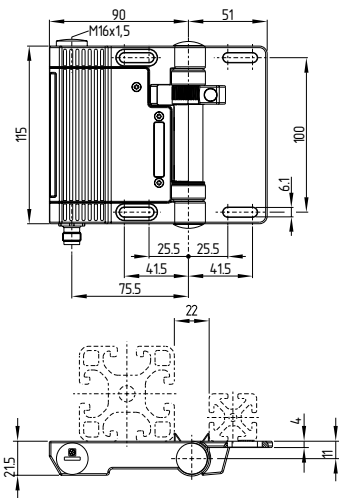

TESFA/S

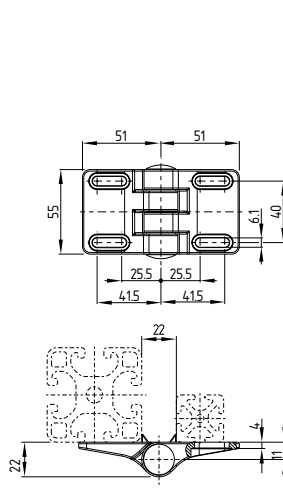

TESF

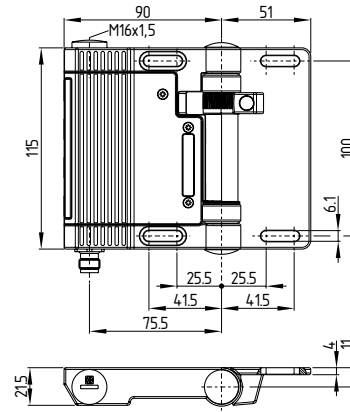

TESF/S

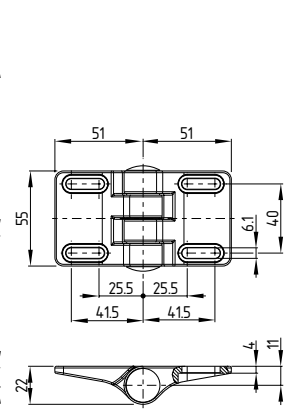

4. Electrical connection

4.1 General information for electrical connection



The electrical connection may only be carried out by authorised personnel in a de-energised condition. For the cable entry, only suitable cable glands and for the connector suitable plugs with an appropriate degree of protection must be used.

1. Open the enclosure cover of the hinge switch.
2. Connect the wires and cables. For flexible leads, conductor ferrules must be used. In the area of the metal thread at the cable input in the wiring compartment, the supplied protective tube (shrink tube) must be used.
3. After the switch has been fitted, the switching function and the opening angle of the safety guard must be checked. The switching angle of the NC contacts set in factory is approximately 3°. Caution: for the TEF.../U version, the following paragraph "Special instructions for the on-site setting" imperatively must be observed!
4. Follow the steps below to put back the enclosure cover:
 - Firmly push the enclosure cover • under an angle of approx. 30° onto the retaining collar (Fig. 2) and simultaneously exercise a downwards pressure (Fig. 3).
 - Uniformly tighten the 3 cover screws (Fig. 4) with 0.6 Nm tightening torque.
 - The contact labelling can be found in the wiring compartment of the switch.

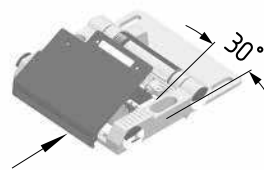

Fig. 2

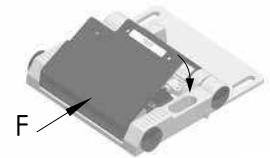

Fig. 3

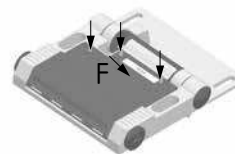

Fig. 4

After the switch has been fitted, the switching function and the opening angle of the safety guard must be checked. The opening angle of the NC contacts set in factory is approximately 3°.

Special instructions for the on-site setting (version TEF.../U)

We recommend a setting including the following steps:

1. Open the safety guard up to the maximum authorised opening angle.
2. Open the enclosure cover of the hinge switch.
3. Wire both NC contacts parallel, connect terminal 11 with 31 and terminal 12 with 32 (Fig. 5).
4. Connect the continuity tester to the terminals 11/12 of the NC contacts or use the test handles at the terminals (Fig. 5).
5. Use the adjustment tool to set the NC contacts so that their opening is ensured at the maximum authorised safety guard opening angle. Turn clockwise to decrease the switching angle, turn counterclockwise to increase the switching angle (Fig. 6); when mounted inside accordingly reversed. The positive break angle is 7° larger than the set switching angle.
6. After the switch is set, the compliance of the switch with the safety-technical requirements of the application must be checked.
7. After the switching angle has been set and checked, the blanking plug for the adjustment opening located at the rear of the adjustment tool must be inserted in the adjustment opening (1) and torn down by making lateral movements (2) with the tool (Fig. 7).



After the desired switching point is set, the opening of the setting option imperatively must be sealed with a blanking plug.

This measure prevents tampering at the set switching point within the meaning of ISO 14119 paragraph 7 and therefore avoids any loss of the safety function of the device.

The blanking plug is injected to the special adjustment tool with a predetermined breaking point.

We recommend an additional painting or glueing of the blanking plug.

Securing the setting screw by means of the blanking plug is a mandatory instruction for the user, which must be observed in order to maintain the CE-Conformity of the component.

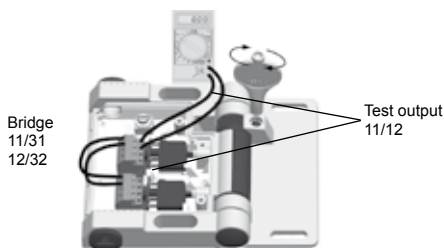

Fig. 5

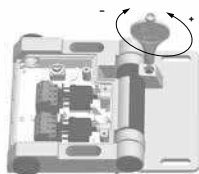

Fig. 6

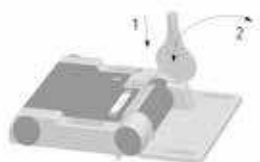

Fig. 7



The versions TEF.../ST24 must only be used in PELV circuits according to EN 60204.

4.2 Contact variants

Contacts are shown with safety guard closed.

TESF... / TEF.../CC

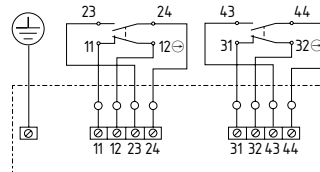

TESF... / TEF.../CC

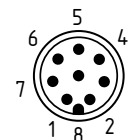
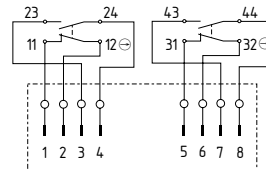

Accessories

Connecting cable with M12 coupling, 8-pole, straight

Type designation	Cable length	Ordering code
A-K8P-M12-S-G-2.5M-BK-2-X-A-4	2.5 m	103011415
A-K8P-M12-S-G-5M-BK-2-X-A-4	5.0 m	103007358
A-K8P-M12-S-G-10M-BK-2-X-A-4	10 m	103007359
A-K8P-M12-S-G-15M-BK-2-X-A-4	15 m	103011414

Pin configuration

Pin	Color
1	WH
2	BN
3	GN
4	YE
5	GY
6	PK
7	BU
8	RD

4.3 Switch travel

Travel / Angle	Terminal Pairs
3° (10°) ⊕	11-12 ⊖ 23-24 31-32 ⊖ 43-44

Key

- ⊖ Positive break NC contact
- ⊕ Positive break travel / -angle, taking tolerances and wear into account

4.4 Door gap calculation

Calculation of the door gap depending on the opening angle, door width and overlapping

β	3°	4°	5°	6°	7°	8°	9°	10°
C	D							
100	5.2	7.0	8.7	10.4	12.2	13.9	15.6	17.4
150	7.8	10.5	13.1	15.7	18.3	20.9	23.5	26.0
200	10.5	13.9	17.4	20.9	24.4	27.8	31.3	34.7
250	13.1	17.4	21.8	26.1	30.5	34.8	39.1	43.3
300	15.7	20.9	26.1	31.3	36.5	41.7	46.9	52.1
350	18.3	24.4	30.5	36.6	42.6	48.7	54.7	60.7
400	20.9	27.9	34.8	41.8	48.7	55.6	62.5	69.4
450	23.5	31.4	39.2	47.0	54.8	62.6	70.4	78.1
500	26.2	34.9	43.6	52.2	60.9	69.6	78.2	86.8
550	28.8	38.3	47.9	57.5	67.0	76.5	86.0	95.5
600	31.4	41.8	52.3	62.7	73.1	83.5	93.8	104.1
650	34.0	45.3	56.6	67.9	79.2	90.4	101.6	112.8
700	36.6	48.8	61.0	73.1	85.3	97.4	109.4	121.5
750	39.2	52.3	65.3	78.4	91.4	104.3	117.3	130.2
800	41.8	55.8	69.7	83.6	97.4	111.3	125.1	138.8
850	44.5	59.3	74.0	88.8	103.5	118.2	132.9	147.5
900	47.1	62.7	78.4	94.0	109.6	125.2	140.7	156.2
950	49.7	66.2	82.8	99.3	115.7	132.1	148.5	164.9
1,000	52.3	69.7	87.1	104.5	121.8	139.1	156.4	173.6
1,050	54.9	73.2	91.5	109.7	127.9	146.1	164.2	182.2
1,100	57.5	76.7	95.8	114.9	134.0	153.0	172.0	190.9
1,150	60.2	80.2	100.2	120.1	140.1	160.0	179.8	199.6
1,200	62.8	83.7	104.5	125.4	146.2	166.9	187.6	208.3
1,250	65.4	87.2	108.9	130.6	152.3	173.9	195.4	217.0
1,300	68.0	90.6	113.2	135.8	158.4	180.8	203.3	225.6
1,350	70.6	94.1	117.6	141.0	164.4	187.8	211.1	234.3
1,400	73.2	97.6	122.0	146.3	170.5	194.7	218.9	243.0
1,450	75.8	101.1	126.3	151.5	176.6	201.7	226.7	251.7
1,500	78.5	104.6	130.7	156.7	182.7	208.7	234.5	260.3

β = Door opening angle
 C = Door width in mm
 D = Door gap in mm for overlapping B = 0 mm
 B = Door thickness

Calculation example

The actual door gap "D1" is calculated using door gap "D" calculated by means of the table above minus the overlapping "B" of door and frame:

$$D1 = D - B$$

Example:

A door made of 40 mm aluminium profile with a length of 950 mm should be secured with a TESH. The safety contact of the TESH opens to 3° when new according to the technical safety sheet (10° at the end of its service life). The table above shows the door gap when new at approx. 49.7 mm. The real door gap can be calculated with the following equation $D1 = D - B$; $(49.7 - 40 = 9.7)$; $D1 = 9.7$ mm. At the end of the service life the door gap is approx. 164.9 mm and the real door gap is $(164.9 - 40 = 124.9)$; $D1 = 124.9$ mm.

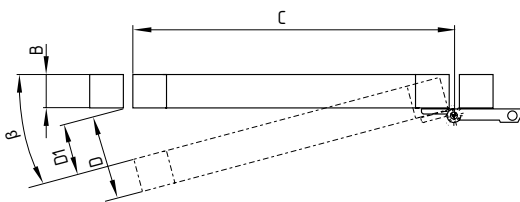

5. Set-up and maintenance

5.1 Functional testing

The safety function of the safety components must be tested. The following conditions must be previously checked and met:

1. Correct fixing of the component
2. Check the integrity of the cable entry and connections
3. Check the switch enclosure for damage

5.2 Maintenance

A regular visual inspection and functional test, including the following steps, is recommended:

1. Check fitting of the hinge safety switch
2. Remove particles of dust and soiling
3. Check cable entry and connections
4. Examination of the switching angle

Damaged or defective components must be replaced.

6. Disassembly and disposal

6.1 Disassembly

The safety switchgear must be disassembled in a de-energised condition only.

6.2 Disposal

The safety switchgear must be disposed of in an appropriate manner in accordance with the national prescriptions and legislations.

7.1 EC Declaration of conformity

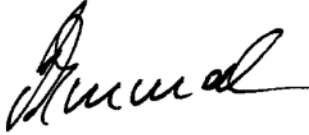
	
EC Declaration of conformity	
Translation of the original Declaration of Conformity	K.A. Schmersal GmbH & Co. KG Möddinghofe 30 42279 Wuppertal Germany Internet: www.schmersal.com
We hereby certify that the hereafter described safety components both in its basic design and construction conform to the applicable European Directives.	
Name of the safety component:	TESF
Type:	Refer to 2.1 Ordering code
Description of the safety component:	Hinge safety switch
Harmonised EC-Directives:	2006/42/EC-EC-Machinery Directive
Person authorised for the compilation of the technical documentation:	Oliver Wacker Möddinghofe 30 42279 Wuppertal
Place and date of issue:	Wuppertal, December 7, 2015
TESF-EEN	
	Authorised signature Philip Schmersal Managing Director



The currently valid declaration of conformity can be downloaded from the internet at www.schmersal.net.



K.A. Schmersal GmbH & Co. KG
Möddinghofe 30, D - 42279 Wuppertal
Postfach 24 02 63, D - 42232 Wuppertal

Phone: +49 - (0)2 02 - 64 74 - 0
Telefax: +49 - (0)2 02 - 64 74 - 1 00
E-Mail: info@schmersal.com
Internet: <http://www.schmersal.com>