



**EN** Operating instructions. . . . .pages 1 to 6  
Original

**Content**

**1 About this document**

1.1 Function . . . . . 1

1.2 Target group: authorised qualified personnel. . . . . 1

1.3 Explanation of the symbols used . . . . . 1

1.4 Appropriate use . . . . . 1

1.5 General safety instructions . . . . . 1

1.6 Warning about misuse . . . . . 1

1.7 Exclusion of liability . . . . . 2

**2 Product description**

2.1 Ordering code . . . . . 2

2.2 Special versions. . . . . 2

2.3 Destination and use . . . . . 2

2.4 Technical data . . . . . 2

2.5 Safety classification . . . . . 2

**3 Mounting**

3.1 General mounting instructions . . . . . 3

3.2 Dimensions . . . . . 3

**4 Electrical connection**

4.1 General information for electrical connection. . . . . 4

4.2 Contact variants. . . . . 4

4.3 Switch travel. . . . . 5

**5 Set-up and maintenance**

5.1 Functional testing. . . . . 5

5.2 Maintenance . . . . . 5

**6 Disassembly and disposal**

6.1 Disassembly. . . . . 5

6.2 Disposal. . . . . 5

**7 EU Declaration of conformity**

**1. About this document**

**1.1 Function**

This operating instructions manual provides all the information you need for the mounting, set-up and commissioning to ensure the safe operation and disassembly of the safety switchgear. The operating instructions must be available in a legible condition and a complete version in the vicinity of the device.

**1.2 Target group: authorised qualified personnel**

All operations described in this operating instructions manual must be carried out by trained specialist personnel, authorised by the plant operator only.

Please make sure that you have read and understood these operating instructions and that you know all applicable legislations regarding occupational safety and accident prevention prior to installation and putting the component into operation.

The machine builder must carefully select the harmonised standards to be complied with as well as other technical specifications for the selection, mounting and integration of the components.

**1.3 Explanation of the symbols used**



**Information, hint, note:**

This symbol is used for identifying useful additional information.



**Caution:** Failure to comply with this warning notice could lead to failures or malfunctions.

**Warning:** Failure to comply with this warning notice could lead to physical injury and/or damage to the machine.

**1.4 Appropriate use**

The products described in these operating instructions are developed to execute safety-related functions as part of an entire plant or machine. It is the responsibility of the manufacturer of a machine or plant to ensure the correct functionality of the entire machine or plant.

The safety switchgear must be exclusively used in accordance with the versions listed below or for the applications authorised by the manufacturer. Detailed information regarding the range of applications can be found in the chapter "Product description".

**1.5 General safety instructions**

The user must observe the safety instructions in this operating instructions manual, the country-specific installation standards as well as all prevailing safety regulations and accident prevention rules.



Further technical information can be found in the Schmersal catalogues or in the online catalogue on the Internet: [www.schmersal.net](http://www.schmersal.net).

The information contained in this operating instructions manual is provided without liability and is subject to technical modifications.

There are no residual risks, provided that the safety instructions as well as the instructions regarding mounting, commissioning, operation and maintenance are observed.

**1.6 Warning about misuse**



In case of improper use or manipulation of the safety switchgear, personal hazards or damages to machinery or plant components cannot be excluded when safety switchgear is used. The relevant requirements of the standard ISO 14119 must be observed.

### 1.7 Exclusion of liability

We shall accept no liability for damages and malfunctions resulting from defective mounting or failure to comply with this operating instructions manual. The manufacturer shall accept no liability for damages resulting from the use of unauthorised spare parts or accessories.

For safety reasons, invasive work on the device as well as arbitrary repairs, conversions and modifications to the device are strictly forbidden; the manufacturer shall accept no liability for damages resulting from such invasive work, arbitrary repairs, conversions and/or modifications to the device.

## 2. Product description

### 2.1 Ordering code

This operating instructions manual applies to the following types:

No.	Option	Description
①	X	Aluminium hinge Stainless steel hinge
②	R	Mechanical restart interlock
③	10	1 NC
	102	1 NC / 1 NO
	110	2 NC
	1102	2 NC / 1 NO
	1110	3 NC
④		Screw connection
	ST1	Connector bottom (M12, 8 pole)
	ST2	Connector top (M12, 8 pole)
⑤		With additional hinge
	S	Without additional hinge
⑥	30	Fixing holes for 30 mm profile systems
	35	Fixing holes for 35 mm profile systems Fixing holes for 40 mm profile systems
	45	Fixing holes for 45 mm profile systems
⑦		Switching angle NC contact at 4 degrees
	5°	Switching angle NC contact at 5 degrees
	8°	Switching angle NC contact at 8 degrees

Not all component variants, which are possible according to this order code, are available.



The types TESZR... mentioned below 2.1 as well as the versions with ...ST1..., ...ST2... and ...5°, ...8° are not included in the prototype test.  
The mechanical reset of the TESZR... must not be used as single start command for a hazardous movement.

### 2.2 Special versions

For special versions, which are not listed in the order code below 2.1, these specifications apply accordingly, provided that they correspond to the standard version.

### 2.3 Destination and use

The TESZ hinge safety switch has been designed to prevent, in conjunction with the control part of a machine, movable safety guards from being opened before hazardous conditions have been eliminated. They are also suitable for fitting on profile sections and existing equipment.



Hinge safety switches can only be used for applications, in which the hazardous condition is terminated without delay (e.g. run-on movements) when the safety guard is opened.



The user must evaluate and design the safety chain in accordance with the relevant standards and depending on the required safety level.



The entire concept of the control system, in which the safety component is integrated, must be validated to the relevant standards.

### 2.4 Technical data

Standards:	IEC 60947-5-1, BG-GS-ET-15
Enclosure:	glass-fibre reinforced thermoplastic, self-extinguishing
Hinge:	TESZ, aluminium / TESZX stainless steel
Contact material:	Silver
Protection class:	IP65
Contact type:	NC contact with double break Y NO contact with double break X
Switching system:	⊖ IEC 60947-5-1 slow action, NC contact with positive break
Connection:	screw terminals or connector
Cable type:	solid wire
Cable section:	min. 0.5 mm <sup>2</sup> , max. 0.75 mm <sup>2</sup> , except TESZ..1102 and TESZ..1110
Cable type:	solid and stranded wire
Cable section:	min. 0.5 mm <sup>2</sup> , max. 1.5 mm <sup>2</sup> with conductor ferrules, - TESZ..1102 and TESZ..1110: max. 1 mm <sup>2</sup> with conductor ferrules
Cable entry:	2 x M20
Positive break angle:	10°
Actuating speed:	max. 135°/0.2 s
Actuating frequency:	max. 120 operations/h
Mechanical life:	> 1 million operations TESZR...: 100,000 operations
Ambient temperature:	-25 °C ... +65 °C
Utilisation category:	AC-15, DC-13
Rated operating current/voltage I <sub>e</sub> /U <sub>e</sub> :	
- with cable:	2 A / 230 VAC 1 A / 24 VDC
- with connector:	2 A / 24 VAC 1 A / 24 VDC
Rated insulation voltage U <sub>i</sub> :	250 V
- with connector:	36 V
Rated impulse withstand voltage U <sub>imp</sub> :	2.5 kV
- with connector:	0.8 kV
Thermal test current I <sub>the</sub> :	2.5 A
Max. rated operating voltage U <sub>e max</sub> :	230 VAC, 24 VDC
- with connector:	24 VAC
Max. fuse rating:	2 A gG D-fuse
Switching of low voltages:	1 mA / 5 VDC
UL:	Listed 15 HA - Industrial Control Equipment - Enclosure Type I - "Use Copper Wire Only" - "Use 60 / 75° Wire Only" - Tightening Torque 0.8 Nm The hub shall be connected to the conduit before it is connected to the enclosure. Only use as an end-of-line enclosure.

### 2.5 Safety classification

Standards:	ISO 13849-1
Envisaged structure:	
- Basically:	applicable up to Cat. 1 / PL c
- With 2-channel usage and fault exclusion mechanism*:	applicable up to Cat. 3 / PL d with suitable logic unit
B <sub>10d</sub> NC contact:	2,000,000
B <sub>10d</sub> NO contact at 10% ohmic contact load:	1,000,000
Service life:	20 years
* If a fault exclusion to the 1-channel mechanics is authorised.	

$$MTTF_d = \frac{B_{10d}}{0,1 \times n_{op}} \quad n_{op} = \frac{d_{op} \times h_{op} \times 3600 \text{ s/h}}{t_{cycle}}$$

(Determined values can vary depending on the application-specific parameters h<sub>op</sub>, d<sub>op</sub> and t<sub>cycle</sub> as well as the load.)

If multiple safety components are wired in series, the Performance Level to ISO 13849-1 will be reduced due to the restricted error detection under certain circumstances.

### 3. Mounting

#### 3.1 General mounting instructions



During fitting of the actuator and the sensor, the requirements of ISO 14119, especially paragraph 7 must be observed!

Four mounting holes are provided for fixing the switch. When used in applications with function for the protection of man, the components must be fitted so that disassembly is prevented (e.g. drill out the hexagonal recess of the fixing screws, blocking the hexagonal recess using a plastic cone diameter 5.1 mm).

The hinge safety switch is double insulated. The use of an earth wire is not authorised. The hinge safety switch must not be used as an end stop. Any mounting position. The mounting position however is chosen so that the components are preferably fitted in the upper part of the safety guard to avoid the ingress of dirt and soiling as well as damage to the components. In case of painting activities, the components must be covered. The supplied fixing material must be used. We recommend that the fixing screws are painted after the component is fitted.



Please observe the relevant requirements of the standards EN ISO 12100, EN 953 and ISO 14119. Also observe the safety distances to the standards ISO 13857 and EN 349.

#### 3.2 Dimensions

All measurements in mm.

##### TESZ... / 30

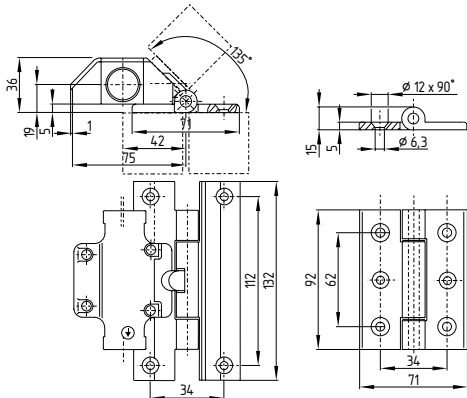

##### TESZ... / 35

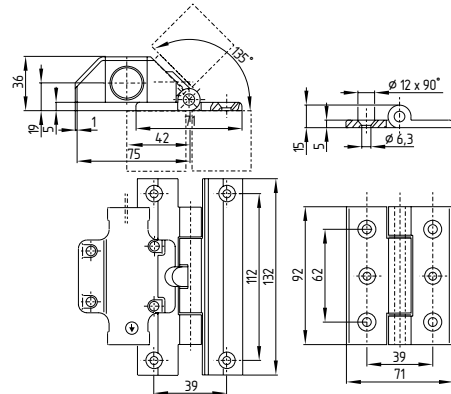

##### TESZ...

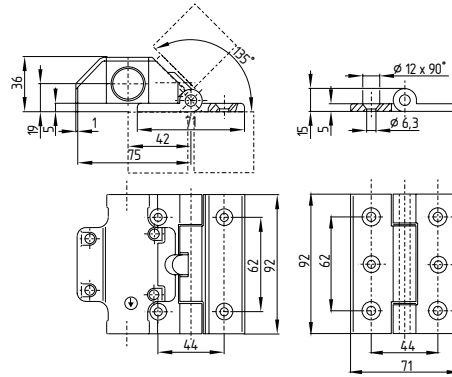

##### TESZX...

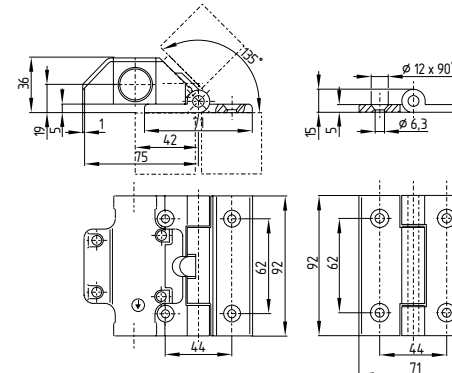

##### TESZ... / 45

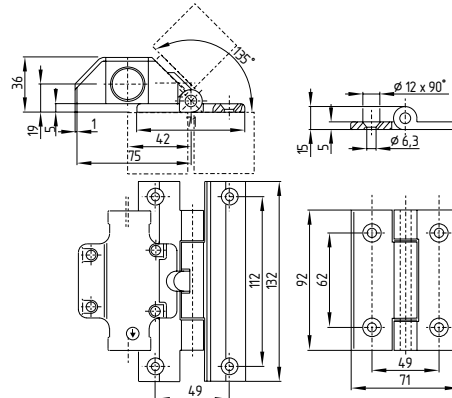

##### TESZR...: a) Reset-button

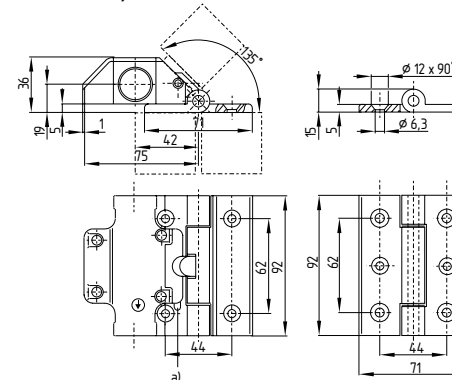

### 4. Electrical connection

#### 4.1 General information for electrical connection



The electrical connection may only be carried out by authorised personnel in a de-energised condition. For the cable entry, only use suitable plastic cable glands and for the connector suitable plugs with an appropriate degree of protection must be used.

1. Remove the switching block prior to the wiring (Fig. 1).
2. If necessary, break out one or both removable openings using a suitable tool. Fit the plastic cable glands M20 x 1.5 with gaskets.
3. Pull the cable through the gland. Connect the wires and cables. The contact labelling can be found on the contact elements.
4. Put back the switching block in the enclosure (Fig. 2). The cable must be laid so that no mechanical stress is exerted on the switch inserts. Tighten the wires and cables, check cable fixation and arrange the inner cables and wires.
5. After wiring, the wiring compartment must be cleaned (i.e. remove excess cables etc.).
6. The fixing screws for the wiring compartment cover must be tightened uniformly with 0.8 Nm tightening torque.

After the switch has been fitted, the switching function and the opening angle of the safety guard must be checked. The aperture angle of the NC contacts set in factory is approx. 3.5 ... 4° (for version ...5° approx. 4 ... 6°; for version ...8° approx. 6 ... 8.5°). Please observe that during the wiring the individual switch inserts nor the complete contact blocks are mixed up, otherwise the preset switching angle is no longer guaranteed.

Fig. 1

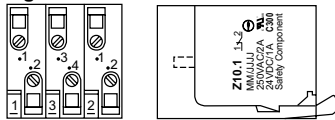
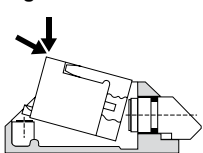

Fig. 2



#### 4.2 Contact variants

Contacts are shown with safety guard closed.

##### TESZ..10..

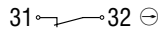

##### TESZ..102..

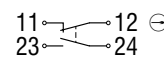

##### TESZ..110..

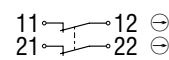

##### TESZ..1102..

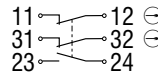

##### TESZ..1110..

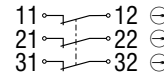

##### TESZ..1102ST..

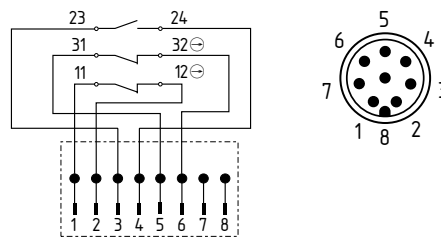

#### Accessories

##### Connecting cable with M12 coupling, 8 pole

Cable length 5 m

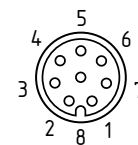

1	WH
2	BN
3	GN
4	YE
5	GY
6	PK
7	BU
8	RD

straight

101183472

### 4.3 Switch travel

Angle specifications show the positive break angle, taking tolerances and wear into account.

#### TESZ Standard

##### 1 NC

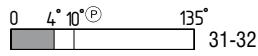

##### 1 NO / 1 NC

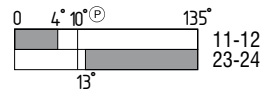

##### 2 NC

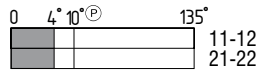

##### 1 NO / 2 NC

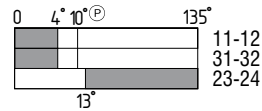

##### 3 NC

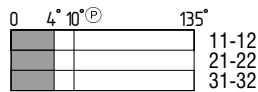

#### TESZ / 5°

##### 1 NC

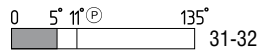

##### 1 NO / 1 NC

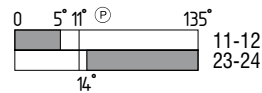

##### 2 NC

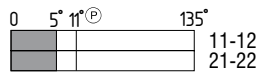

##### 1 NO / 2 NC

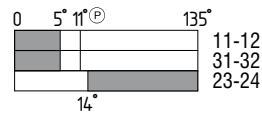

##### 3 NC

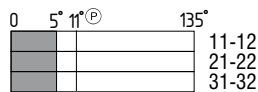

#### TESZ... / 8°

##### 1 NC

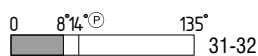

##### 1 NO / 1 NC

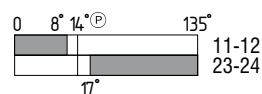

##### 2 NC

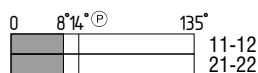

##### 1 NO / 2 NC

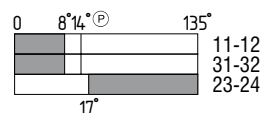

##### 3 NC

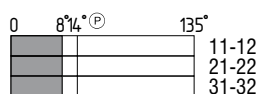

#### Key

- ⊖ Positive break NC contact
- T Positive break travel / -angle

## 5. Set-up and maintenance

### 5.1 Functional testing

The safety function of the safety components must be tested. The following conditions must be previously checked and met:

1. Correct fixing of the component
2. Check the integrity of the cable entry and connections
3. Check the switch enclosure for damage

### 5.2 Maintenance

A regular visual inspection and functional test, including the following steps, is recommended:

1. Check fitting of the hinge safety switch
2. Remove particles of dust and soiling
3. Check cable entry and connections
4. Examination of the switching angle

**Damaged or defective components must be replaced.**

## 6. Disassembly and disposal

### 6.1 Disassembly

The safety switchgear must be disassembled in a de-energised condition only.

### 6.2 Disposal

The safety switchgear must be disposed of in an appropriate manner in accordance with the national prescriptions and legislations.

7. EU Declaration of conformity

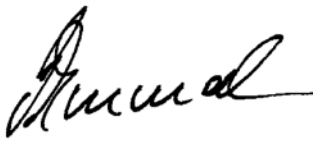
<b>EU Declaration of conformity</b>		 <b>SCHMERSAL</b>
Original	K.A. Schmersal GmbH & Co. KG Möddinghofe 30 42279 Wuppertal Germany Internet: www.schmersal.com	
We hereby certify that the hereafter described components both in their basic design and construction conform to the applicable European Directives.		
<b>Name of the component:</b>	TESZ	
<b>Type:</b>	See ordering code	
<b>Description of the component:</b>	Hinge safety switch	
<b>Relevant Directives:</b>	Machinery Directive RoHS-Directive	2006/42/EC 2011/65/EU
<b>Applied standards:</b>	DIN EN 60947-5-1: 2010, DIN EN ISO 14119: 2014	
<b>Person authorized for the compilation of the technical documentation:</b>	Oliver Wacker Möddinghofe 30 42279 Wuppertal	
<b>Place and date of issue:</b>	Wuppertal, February 1, 2016	
TESZ-E-EN		
	Authorised signature <b>Philip Schmersal</b> Managing Director	



The currently valid declaration of conformity can be downloaded from the internet at [www.schmersal.net](http://www.schmersal.net).



**K. A. Schmersal GmbH & Co. KG**  
Möddinghofe 30, D - 42279 Wuppertal  
Postfach 24 02 63, D - 42232 Wuppertal

Phone: +49 - (0)2 02 - 64 74 - 0  
Telefax: +49 - (0)2 02 - 64 74 - 1 00  
E-Mail: [info@schmersal.com](mailto:info@schmersal.com)  
Internet: <http://www.schmersal.com>