



EN Operating instructions.pages 1 to 6
Translation of the original operating instructions

Content

1 About this document

1.1 Function 1

1.2 Target group: authorised qualified personnel. 1

1.3 Explanation of the symbols used 1

1.4 Appropriate use 1

1.5 General safety instructions 1

1.6 Warning about misuse 1

1.7 Exclusion of liability 2

2 Product description

2.1 Ordering code 2

2.2 Special versions. 2

2.3 Destination and use 2

2.4 Technical data 2

2.5 Safety classification 2

3 Mounting

3.1 General mounting instructions 3

3.2 Dimensions 3

4 Electrical connection

4.1 General information for electrical connection. 3

4.2 Contact variants. 4

4.3 Switch travel diagrams 4

5 Set-up and maintenance

5.1 Functional testing. 4

5.2 Maintenance 4

6 Disassembly and disposal

6.1 Disassembly. 4

6.2 Disposal. 4

7 Appendix

7.1 EC Declaration of conformity 5

1. About this document

1.1 Function

This operating instructions manual provides all the information you need for the safe mounting, set-up and commissioning to ensure the safe operation and disassembly of the safety switchgear. The operating instructions must be available in a legible condition and a complete version in the vicinity of the device.

1.2 Target group: authorised qualified personnel

All operations described in this operating instructions manual must be carried out by trained specialist personnel, authorised by the plant operator only.

Please make sure that you have read and understood these operating instructions and that you know all applicable legislations regarding occupational safety and accident prevention prior to installation and putting the component into operation.

The machine builder must carefully select the harmonised standards to be complied with as well as other technical specifications for the selection, mounting and integration of the components.

1.3 Explanation of the symbols used



Information, hint, note:
This symbol is used for identifying useful additional information.



Caution: Failure to comply with this warning notice could lead to failures or malfunctions.
Warning: Failure to comply with this warning notice could lead to physical injury and/or damage to the machine.

1.4 Appropriate use

The products described in these operating instructions are developed to execute safety-related functions as part of an entire plant or machine. It is the responsibility of the manufacturer of a machine or plant to ensure the correct functionality of the entire machine or plant.

The safety switchgear must be exclusively used in accordance with the versions listed below or for the applications authorised by the manufacturer. Detailed information regarding the range of applications can be found in the chapter "Product description".

1.5 General safety instructions

The user must observe the safety instructions in this operating instructions manual, the country-specific installation standards as well as all prevailing safety regulations and accident prevention rules.



Further technical information can be found in the Schmersal catalogues or in the online catalogue on the Internet:
www.schmersal.net.

The information contained in this operating instructions manual is provided without liability and is subject to technical modifications.

There are no residual risks, provided that the safety instructions as well as the instructions regarding mounting, commissioning, operation and maintenance are observed.

1.6 Warning about misuse



In case of improper use or manipulation of the safety switchgear, personal hazards or damages to machinery or plant components cannot be excluded when safety switchgear is used. The relevant requirements of the standard ISO 14119 must be observed.

1.7 Exclusion of liability

We shall accept no liability for damages and malfunctions resulting from defective mounting or failure to comply with this operating instructions manual. The manufacturer shall accept no liability for damages resulting from the use of unauthorised spare parts or accessories.

For safety reasons, invasive work on the device as well as arbitrary repairs, conversions and modifications to the device are strictly forbidden; the manufacturer shall accept no liability for damages resulting from such invasive work, arbitrary repairs, conversions and/or modifications to the device.

2. Product description

2.1 Ordering code

This operating instructions manual applies to the following types:

TV1S 325-3Z-4

No.	Option	Description
①	8	Shaft bore \varnothing 8 mm
	10	Shaft bore \varnothing 10 mm
②	3	Slim design
	5	Large design
③	02	2 NC contacts
	03	3 NC contacts
	11	1 NO contact / 1 NC contact
	12	1 NO contact / 2 NC contacts
④		Cable entry M20
	NPT	Cable entry NPT 1/2"
	ST	M12 connector (A coding)
	2310	M12 connector (B coding)



Only if the information described in this operating instructions manual are realised correctly, the safety function and therefore the compliance with the Machinery Directive is maintained.

2.2 Special versions

For special versions, which are not listed in the order code below 2.1, these specifications apply accordingly, provided that they correspond to the standard version.

2.3 Destination and use

The hinge safety switches (Type 1 according to ISO 14119) are suitable for hinged guards, which need to be closed in order to provide for the necessary operational safety.



The user must evaluate and design the safety chain in accordance with the relevant standards and the required safety level.



The entire concept of the control system, in which the safety component is integrated, must be validated to the relevant standards.

2.4 Technical data

Standards:	IEC 60947-5-1; ISO 13849-1, BG-GS-ET-15
Design:	EN 50041
Enclosure:	light-alloy diecast, paint finish
Protection class:	IP67
Contact material:	Silver
Contact type:	change-over contact with double break, type Zb or 1 NC or 2 NC contacts, with galvanically separated contact bridges
Switching system:	⊖ IEC 60947-5-1; slow action, NC contact with positive break
Connection:	screw terminals
Cable section (rigid / flexible):	min. 0.75 mm ² , max. 2.5 mm ² (including conductor ferrules)
Cable entry:	TV.S 335: 1 x M20 TV.S 355: 3 x M20
Rated impulse withstand voltage U _{imp} :	6 kV;
- connector:	0.8 kV
Rated insulation voltage U _i :	500 V;
- connector:	50 V
Thermal test current I _{the} :	10 A
Utilisation category:	AC-15, DC-13
Rated operating current/voltage I _e /U _e :	4 A / 230 VAC, 4 A / 24 VDC
- connector:	50 V
Required short-circuit current:	1000 A
Max. fuse rating:	6 A gG D-fuse
Ambient temperature:	-25 °C ... +70 °C
Mechanical life:	1 million operations
Max. switching frequency:	1000/h
Shaft bore:	\varnothing 8 mm / 10 mm
Positive break angle:	7°
Positive break torque:	0.6 Nm

2.5 Safety classification

Standards:	ISO 13849-1
Envisaged structure:	
- Basically:	applicable up to Cat. 1 / PL c
- With 2-channel usage and fault exclusion mechanism*:	applicable up to Cat. 3 / PL d with suitable logic unit
B _{10d} (NC contact):	20,000,000
B _{10d} (NO contact) at 10% ohmic contact load:	1,000,000
Service life:	20 years

* If a fault exclusion to the 1-channel mechanics is authorised.

$$MTTF_d = \frac{B_{10d}}{0,1 \times n_{op}} \quad n_{op} = \frac{d_{op} \times h_{op} \times 3600 \text{ s/h}}{t_{cycle}}$$

(Determined values can vary depending on the application-specific parameters h_{op}, d_{op} and t_{cycle} as well as the load.)

If multiple safety components are wired in series, the Performance Level to ISO 13849-1 will be reduced due to the restricted error detection under certain circumstances.

3. Mounting

3.1 General mounting instructions

The mounting dimensions are mentioned at the rear of the enclosure. Fit the hinge safety switch so that the shaft of the hinge safety switch is aligned with the pin of the door hinge. Use the supplied tamperproof safety screws to fix the hinge safety switch. To set the switching point, first adjust the plug/shaft connection by means of a threaded pin. Then establish the positive link between the shaft and the door hinge. To that effect, use the offset arranged mounting holes and the supplied spiral clamping pin. The switch enclosure must not be used as end stop. Any mounting position. The head can be turned by 4 x 90°. Loosen the four screws of the head by means of a Torx screwdriver (T 20), turn the head in the desired position and retighten the screws.

3.2 Dimensions

All measurements in mm.

TV.S 335

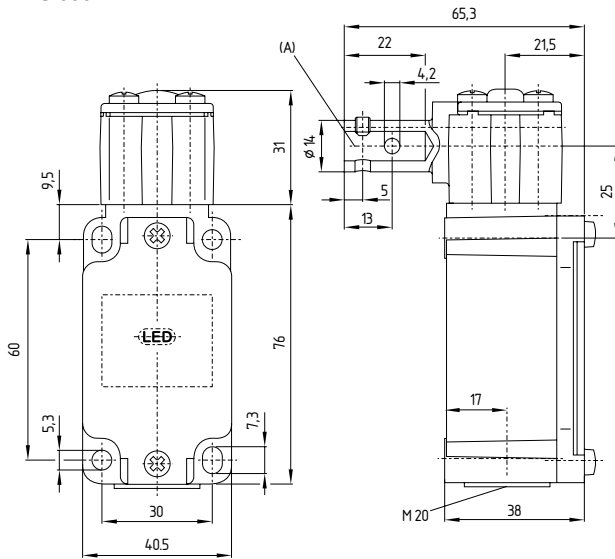

TV.S 355

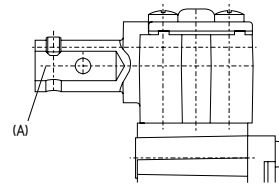
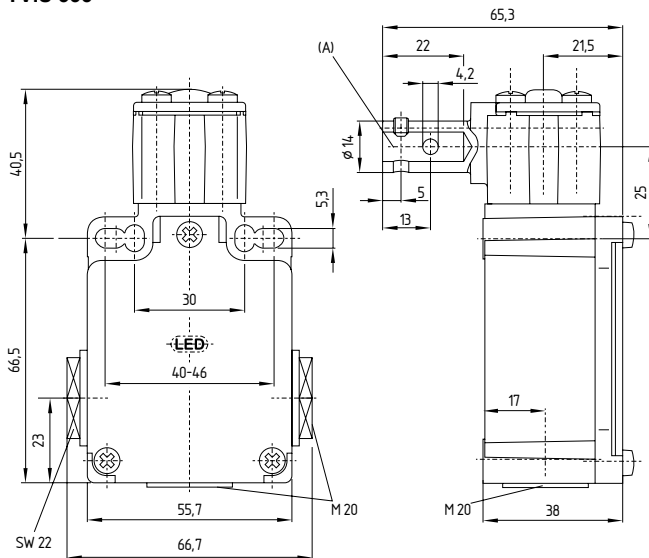

A = TV8S 335/355: \varnothing 8 mm
TV10S 335/355: \varnothing 10 mm



Please observe the remarks of the standards ISO 12100, EN 953 and ISO 14119.

4. Electrical connection

4.1 General information for electrical connection



The electrical connection may only be carried out by authorised personnel in a de-energised condition.

The contact labelling can be found in the wiring compartment of the switch. For the cable entry, suitable cable glands with an appropriate degree of protection must be used. Non-used input openings must be sealed by means of threaded plugs. After wiring, dust and soiling must be removed from the wiring compartment.



According to IEC 60204-1, the versions with connector must only be used in PELV circuits.

4.2 Contact variants

Contacts are shown with safety guard closed. The switch is in resting position.

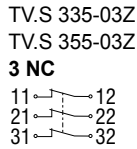
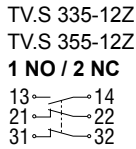
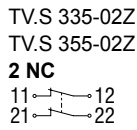
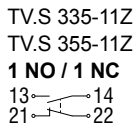

with connector

TV.S 335-11Z-ST
TV.S 355-11Z-ST
1 NO / 1 NC

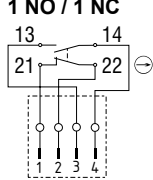

TV.S 335-02Z-ST
TV.S 355-02Z-ST
2 NC

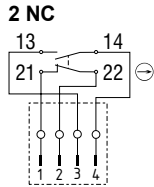

LED version

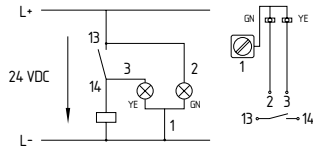

4.3 Switch travel diagrams

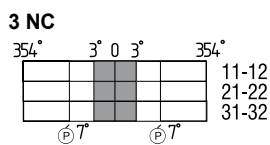
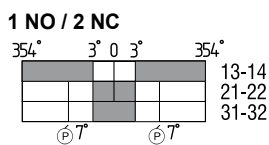
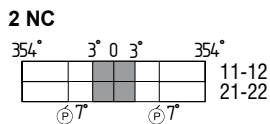
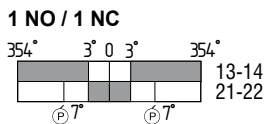

5. Set-up and maintenance

5.1 Functional testing

The safety function of the safety components must be tested. The following conditions must be previously checked and met:

1. Check the positive link between the shaft and the door hinge
2. Check for correct installation of the hinge safety switch
3. Check the switch enclosure for damage
4. Check the integrity of the cable entry and connections

5.2 Maintenance

In case of correct installation in accordance with the instructions described above, the component requires little maintenance. A regular visual inspection and functional test, including the following steps, is recommended:

1. Check the positive link between the shaft and the door hinge
2. Check for correct installation of the hinge safety switch
3. Remove particles of dust and soiling
4. Check cable entry and connections

Damaged or defective components must be replaced.

6. Disassembly and disposal

6.1 Disassembly

The safety switchgear must be disassembled in a de-energised condition only.

6.2 Disposal

The safety switchgear must be disposed of in an appropriate manner in accordance with the national prescriptions and legislations.

7. Appendix

7.1 EC Declaration of conformity

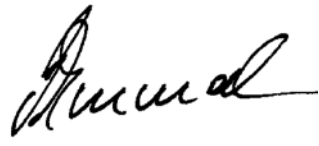
	
<h2>EC Declaration of conformity</h2>	
Translation of the original Declaration of Conformity	K.A. Schmersal GmbH & Co. KG Möddinghofe 30 42279 Wuppertal Germany Internet: www.schmersal.com
<p>We hereby certify that the hereafter described safety components both in its basic design and construction conform to the applicable European Directives.</p>	
Name of the safety component / type:	TV.S 335 TV.S 355
Description of the safety component:	Hinge safety switch
Harmonised EC-Directives:	2006/42/EC-EC-Machinery Directive
Person authorised for the compilation of the technical documentation:	Oliver Wacker Möddinghofe 30 42279 Wuppertal
Place and date of issue:	Wuppertal, October 6, 2015
TVS335_355-C-EN	
	Authorised signature Philip Schmersal Managing Director



The currently valid declaration of conformity can be downloaded from the internet at www.schmersal.net.



K. A. Schmersal GmbH & Co. KG
Möddinghofe 30, D - 42279 Wuppertal
Postfach 24 02 63, D - 42232 Wuppertal

Phone: +49 - (0)2 02 - 64 74 - 0
Telefax: +49 - (0)2 02 - 64 74 - 1 00
E-Mail: info@schmersal.com
Internet: <http://www.schmersal.com>