



**EN** Operating instructions. . . . .pages 1 to 4  
Original

**Content**

**1 About this document**

1.1 Function . . . . . 1

1.2 Target group: authorised qualified personnel. . . . . 1

1.3 Explanation of the symbols used . . . . . 1

1.4 Appropriate use . . . . . 1

1.5 General safety instructions . . . . . 1

1.6 Warning about misuse . . . . . 1

1.7 Exclusion of liability . . . . . 2

**2 Product description**

2.1 Ordering code . . . . . 2

2.2 Special versions. . . . . 2

2.3 Destination and use . . . . . 2

2.4 Technical data . . . . . 2

2.5 Safety classification . . . . . 2

**3 Mounting**

3.1 General mounting instructions . . . . . 3

3.2 Dimensions . . . . . 3

3.3 Choosing the actuating planes. . . . . 3

**4 Electrical connection**

4.1 General information for electrical connection. . . . . 3

4.2 Contact variants. . . . . 3

**5 Set-up and maintenance**

5.1 Functional testing. . . . . 3

5.2 Maintenance . . . . . 3

**6 Disassembly and disposal**

6.1 Disassembly. . . . . 3

6.2 Disposal . . . . . 3

**7 EU Declaration of conformity**

**1. About this document**

**1.1 Function**

This operating instructions manual provides all the information you need for the mounting, set-up and commissioning to ensure the safe operation and disassembly of the safety switchgear. The operating instructions must be available in a legible condition and a complete version in the vicinity of the device.

**1.2 Target group: authorised qualified personnel**

All operations described in this operating instructions manual must be carried out by trained specialist personnel, authorised by the plant operator only.

Please make sure that you have read and understood these operating instructions and that you know all applicable legislations regarding occupational safety and accident prevention prior to installation and putting the component into operation.

The machine builder must carefully select the harmonised standards to be complied with as well as other technical specifications for the selection, mounting and integration of the components.

**1.3 Explanation of the symbols used**



**Information, hint, note:**

This symbol is used for identifying useful additional information.



**Caution:** Failure to comply with this warning notice could lead to failures or malfunctions.

**Warning:** Failure to comply with this warning notice could lead to physical injury and/or damage to the machine.

**1.4 Appropriate use**

The products described in these operating instructions are developed to execute safety-related functions as part of an entire plant or machine. It is the responsibility of the manufacturer of a machine or plant to ensure the correct functionality of the entire machine or plant.

The safety switchgear must be exclusively used in accordance with the versions listed below or for the applications authorised by the manufacturer. Detailed information regarding the range of applications can be found in the chapter "Product description".

**1.5 General safety instructions**

The user must observe the safety instructions in this operating instructions manual, the country-specific installation standards as well as all prevailing safety regulations and accident prevention rules.



Further technical information can be found in the Schmersal catalogues or in the online catalogue on the Internet: [www.schmersal.net](http://www.schmersal.net).

The information contained in this operating instructions manual is provided without liability and is subject to technical modifications.

There are no residual risks, provided that the safety instructions as well as the instructions regarding mounting, commissioning, operation and maintenance are observed.

**1.6 Warning about misuse**



In case of improper use or manipulation of the safety switchgear, personal hazards or damages to machinery or plant components cannot be excluded when safety switchgear is used. The relevant requirements of the standard ISO 14119 must be observed.

### 1.7 Exclusion of liability

We shall accept no liability for damages and malfunctions resulting from defective mounting or failure to comply with this operating instructions manual. The manufacturer shall accept no liability for damages resulting from the use of unauthorised spare parts or accessories.

For safety reasons, invasive work on the device as well as arbitrary repairs, conversions and modifications to the device are strictly forbidden; the manufacturer shall accept no liability for damages resulting from such invasive work, arbitrary repairs, conversions and/or modifications to the device.

## 2. Product description

### 2.1 Ordering code

This operating instructions manual applies to the following types:

#### AZ 3350-①-②-③

No.	Option	Description
①	03-ZK 12-ZUEK	3 NC 1 NO / 2 NC
②	U90  U270	Actuating head can be rotated 90° for door hinge left  Actuating head can be rotated 270° for door hinge right
③	1637	Gold-plated contacts

#### Actuator

- for sliding safety guards:

AZ 3350-B1	Straight actuator with rubber mounting
AZ 3350-B5	Angled actuator with rubber mounting

- for hinged safety guards:

AZ 3350-B1R	Flexible actuator with rubber mounting
AZ 3350-B5R	Angled actuator with rubber mounting
AZ 3350-B6	Flexible actuator with through-holes
AZ 3350-B6H	Flexible actuator with threaded holes, front side

- in combination with AZ 3350...-U90 or U270:

STS 30-01...08	Safety door-handle system for hinged safety guards
----------------	---



Only if the information described in this operating instructions manual are realised correctly, the safety function and therefore the compliance with the Machinery Directive is maintained.

### 2.2 Special versions

For special versions, which are not listed in the order code below 2.1, these specifications apply accordingly, provided that they correspond to the standard version.

### 2.3 Destination and use

The safety switches are suitable for sliding, hinged or removable safety guards, which need to be closed in order to ensure the necessary operational safety.

The safety switches are used for applications, in which the hazardous situation is terminated without delay when the safety guard is opened.



The safety switchgears are classified according to ISO 14119 as type 2 interlocking devices.



The user must evaluate and design the safety chain in accordance with the relevant standards and the required safety level.



The entire concept of the control system, in which the safety component is integrated, must be validated to the relevant standards.

### 2.4 Technical data

Standards:	IEC 60947-5-1, BG-GS-ET-15
Enclosure:	light-alloy diecast, paint finish
Coding level according to ISO 14119:	low
Protection class:	IP67
Contact material:	Silver
Contact type:	change-over with double break Zb, or 3 NC contacts, galvanically separated contact bridges
Switching system:	⊖ IEC 60947-5-1; slow action, NC contact with positive break
Connection:	screw terminals
Cable section:	min. 0.75 mm <sup>2</sup> , max. 2.5 mm <sup>2</sup> (including conductor ferrules)
Cable entry:	M20 x 1.5
Rated impulse withstand voltage U <sub>imp</sub> :	4 kV
Rated insulation voltage U <sub>i</sub> :	250 V
Thermal test current I <sub>th</sub> :	10 A
Utilisation category:	AC-15, DC-13
Rated operating current/voltage I <sub>e</sub> /U <sub>e</sub> :	4 A / 230 VAC 4 A / 24 VDC
Required short-circuit current:	1000 A
Max. fuse rating:	6 A gG D-fuse
Positive break travel:	10.7 mm
Positive break force:	each NC contact 5 N
Ambient temperature:	-30 °C ... +90 °C
Actuating speed:	max. 0.2 ms
Actuating frequency:	max. 1200/h
Mechanical life:	> 1 million operations

### 2.5 Safety classification

Standards:	ISO 13849-1
Envisaged structure:	
- Basically:	applicable up to Cat. 1 / PL c
- With 2-channel usage and fault exclusion mechanism*:	applicable up to Cat. 3 / PL d with suitable logic unit
B <sub>10d</sub> NC contact:	2,000,000
B <sub>10d</sub> NO contact at 10% ohmic contact load:	1,000,000
Service life:	20 years

\* If a fault exclusion to the 1-channel mechanics is authorised.

$$MTTF_d = \frac{B_{10d}}{0,1 \times n_{op}} \quad n_{op} = \frac{d_{op} \times h_{op} \times 3600 \text{ s/h}}{t_{cycle}}$$

(Determined values can vary depending on the application-specific parameters h<sub>op</sub>, d<sub>op</sub> and t<sub>cycle</sub> as well as the load.)

If multiple safety components are wired in series, the Performance Level to ISO 13849-1 will be reduced due to the restricted error detection under certain circumstances.

### 3. Mounting

#### 3.1 General mounting instructions

Four mounting holes are provided for fixing the enclosure. The mounting dimensions are indicated on the rear of the component. The enclosure must not be used as an end stop. Any mounting position. The mounting position must be chosen so as to avoid the penetration of dirt in the used holes.

**Mounting of the actuators:** See mounting instructions actuators.



Please observe the remarks of the standards ISO 12100, EN 953 and ISO 14119.



The safety component and the actuator must be permanently fitted to the safety guards and protected against displacement by suitable measures (tamperproof screws, gluing, drilling, pinning).

#### 3.2 Dimensions

All measurements in mm.

#### AZ 3350

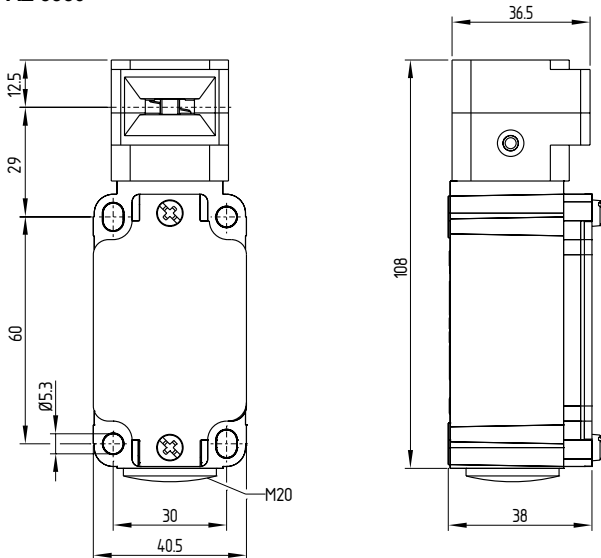

#### 3.3 Choosing the actuating planes

By turning the head in 90° steps, 4 actuating planes are possible. To that effect, the four Torx screws (T15 screwdriver required) must be loosened, slightly lift up the actuating head and rotate it into the desired position; then retighten the four screws.

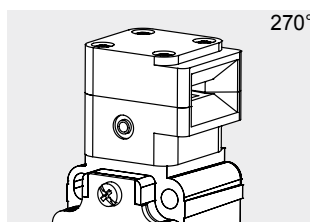
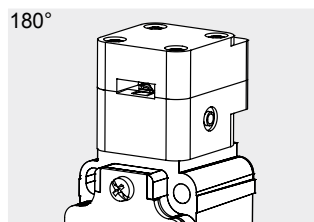
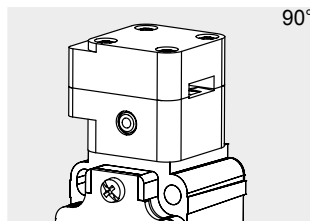
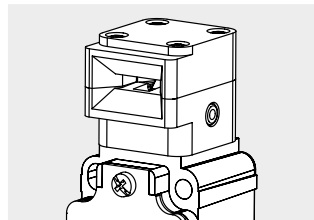

### 4. Electrical connection

#### 4.1 General information for electrical connection



The electrical connection may only be carried out by authorised personnel in a de-energised condition.

The contact labelling can be found in the wiring compartment of the switch. Appropriate cable glands with a suitable degree of protection are to be used. After wiring, dust and soiling must be removed from the wiring compartment.

#### 4.2 Contact variants

Contacts are shown with safety guard closed.

1 NO / 2 NC

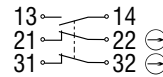

3 NC

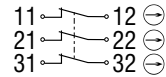

### 5. Set-up and maintenance

#### 5.1 Functional testing

The safety function of the safety components must be tested. The following conditions must be previously checked and met:

1. Check the free movement of the actuating element
2. Check the integrity of the cable entry and connections
3. Check the switch enclosure for damage

#### 5.2 Maintenance

By use in extreme conditions, we recommend routine maintenance including the following steps:

1. Check for correct installation of the actuator and the switch
2. Remove particles of dust and soiling
3. Check cable entry and connections



Adequate measures must be taken to ensure protection against tampering either to prevent tampering of the safety guard, for instance by means of replacement actuators.

**Damaged or defective components must be replaced.**

### 6. Disassembly and disposal

#### 6.1 Disassembly

The safety switchgear must be disassembled in a de-energised condition only.

#### 6.2 Disposal

The safety switchgear must be disposed of in an appropriate manner in accordance with the national prescriptions and legislations.

7. EU Declaration of conformity

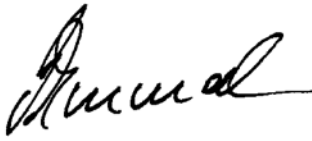
<b>EU Declaration of conformity</b>		
Original	K.A. Schmersal GmbH & Co. KG Möddinghofe 30 42279 Wuppertal Germany Internet: www.schmersal.com	
We hereby certify that the hereafter described components both in their basic design and construction conform to the applicable European Directives.		
<b>Name of the component:</b>	AZ 3350	
<b>Type:</b>	See ordering code	
<b>Description of the component:</b>	Positive break position switch with separate actuator for safety functions	
<b>Relevant Directives:</b>	Machinery Directive RoHS-Directive	2006/42/EG 2011/65/EU
<b>Applied standards:</b>	DIN EN 60947-5-1:2010, DIN EN ISO 14119:2014	
<b>Person authorized for the compilation of the technical documentation:</b>	Oliver Wacker Möddinghofe 30 42279 Wuppertal	
<b>Place and date of issue:</b>	Wuppertal, March 15, 2016	
		
	Authorised signature <b>Philip Schmersal</b> Managing Director	

AZ3350-C-EN



The currently valid declaration of conformity can be downloaded from the internet at [www.schmersal.net](http://www.schmersal.net).



**K. A. Schmersal GmbH & Co. KG**  
Möddinghofe 30, D - 42279 Wuppertal  
Postfach 24 02 63, D - 42232 Wuppertal

Phone: +49 - (0)2 02 - 64 74 - 0  
Telefax: +49 - (0)2 02 - 64 74 - 1 00  
E-Mail: [info@schmersal.com](mailto:info@schmersal.com)  
Internet: <http://www.schmersal.com>