



**EN** Operating instructions. . . . .pages 1 to 6  
Translation of the original operating instructions

**Content**

**1 About this document**

1.1 Function . . . . . 1

1.2 Target group: authorised qualified personnel. . . . . 1

1.3 Explanation of the symbols used . . . . . 1

1.4 General safety instructions . . . . . 1

1.5 Warning about misuse . . . . . 1

1.6 Exclusion of liability . . . . . 1

**2 Product description**

2.1 Ordering code . . . . . 2

2.2 Special versions . . . . . 2

2.3 Destination and use . . . . . 2

**3 Mounting**

3.1 General mounting instructions . . . . . 2

3.2 Dimensions . . . . . 2

3.3 Mounting dimensions . . . . . 3

3.4 Mounting steps - Outside mounting . . . . . 4

3.5 Mounting steps - Inside mounting . . . . . 5

**4 Set-up and maintenance**

4.1 Functional testing . . . . . 6

4.2 Maintenance . . . . . 6

**1. About this document**

**1.1 Function**

This operating instructions manual provides all the information you need for the mounting, set-up and commissioning to ensure the safe operation and disassembly of the safety switchgear. The operating instructions must be available in a legible condition and a complete version in the vicinity of the device.

**1.2 Target group: authorised qualified personnel**

All operations described in this operating instructions manual must be carried out by trained specialist personnel, authorised by the plant operator only.

Please make sure that you have read and understood these operating instructions and that you know all applicable legislations regarding occupational safety and accident prevention prior to installation and putting the component into operation.

The machine builder must carefully select the harmonised standards to be complied with as well as other technical specifications for the selection, mounting and integration of the components.

**1.3 Explanation of the symbols used**



**Information, hint, note:**

This symbol is used for identifying useful additional information.



**Caution:** Failure to comply with this warning notice could lead to failures or malfunctions.

**Warning:** Failure to comply with this warning notice could lead to physical injury and/or damage to the machine.

**1.4 General safety instructions**

The user must observe the safety instructions in this operating instructions manual, the country-specific installation standards as well as all prevailing safety regulations and accident prevention rules.



Further technical information can be found in the Schmersal catalogues or in the online catalogue on the Internet: [www.schmersal.net](http://www.schmersal.net).

The information contained in this operating instructions manual is provided without liability and is subject to technical modifications.

There are no residual risks, provided that the safety instructions as well as the instructions regarding mounting, commissioning, operation and maintenance are observed.

**1.5 Warning about misuse**



In case of inadequate or improper use or manipulations of the component, personal hazards or damage to machinery or plant components cannot be excluded. The relevant requirements of the standard EN 1088 must be observed.

**1.6 Exclusion of liability**

We shall accept no liability for damages and malfunctions resulting from defective mounting or failure to comply with this operating instructions manual. The manufacturer shall accept no liability for damages resulting from the use of unauthorised spare parts or accessories.

For safety reasons, invasive work on the device as well as arbitrary repairs, conversions and modifications to the device are strictly forbidden; the manufacturer shall accept no liability for damages resulting from such invasive work, arbitrary repairs, conversions and/or modifications to the device.

## 2. Product description

### 2.1 Ordering code

This operating instructions manual applies to the following types:

① ② -STS30-③

No.	Option	Description
①	AZ	For safety switch AZ...
	AZM	For solenoid interlock AZM...
②	...	Selection of the series
③	01	Mounting inside, with emergency handle, door hinge right
	02	Mounting inside, with emergency handle, door hinge left
	03	Mounting inside, without emergency handle, door hinge right
	04	Mounting inside, without emergency handle, door hinge left
	05	Mounting outside, with emergency handle, door hinge right
	06	Mounting outside, with emergency handle, door hinge left
	07	Mounting outside, without emergency handle, door hinge right
	08	Mounting outside, without emergency handle, door hinge left



Only if the information described in this operating instructions manual are realised correctly, the safety function and therefore the compliance of the entire system with the Machinery Directive is maintained.

### 2.2 Special versions

For special versions, which are not listed in the order code below 2.1, these specifications apply accordingly, provided that they correspond to the standard version.

### 2.3 Destination and use

The ...-STS30 safety door-handle system is suitable for hinged guards. The solenoid interlocks can be mounted either inside or outside of the hazardous area. The safety guard can be opened and closed from outside by turning the door-handle. The door-handle latches in 90° position. The ...-STS30 system can be supplied with an emergency handle to open the safety guard. When the emergency handle is actuated, the safety guard can be opened from within the hazardous area. The safety guard cannot be closed from inside. The ...-STS30 system can be supplied with a lockout tag preventing the inadvertent closing of the safety guard, for instance during mounting activities on confusing and unclear plants.

## 3. Mounting

### 3.1 General mounting instructions



The fitting may only be carried out by authorised personnel.

### 3.2 Dimensions

All measurements in mm.

AZ 16-STS30-02/-04/-05/-07

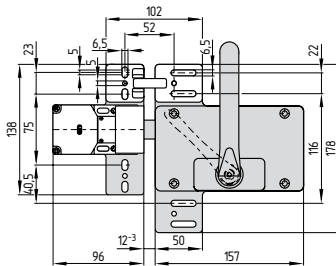

AZ 16-STS30-01/-03/-06/-08

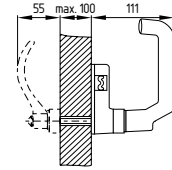
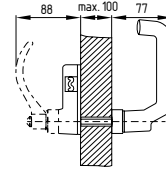
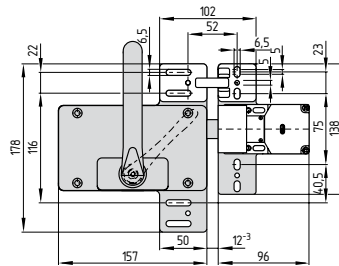

AZ 3350-STS30-02/-04/-05/-07

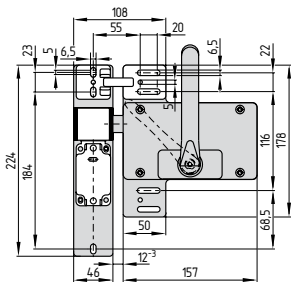

AZ 3350-STS30-01/-03/-06/-08

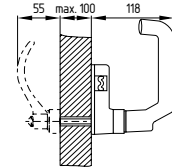
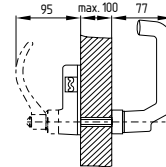
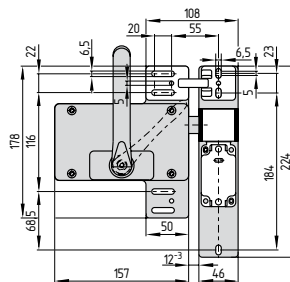

AZ 415-STS30-02/-04/-05/-07

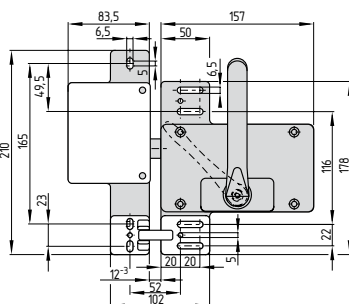

AZ 415-STS30-01/-03/-06/-08

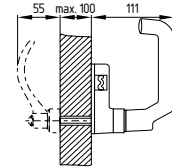
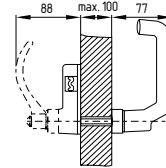
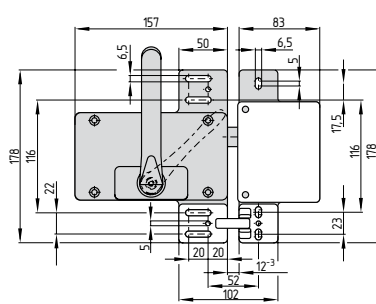

AZM 161-STS30-02/-04/-05/-07

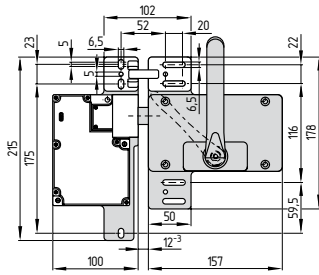

AZM 161-STS30-01/-03/-06/-08

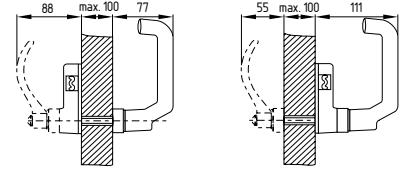
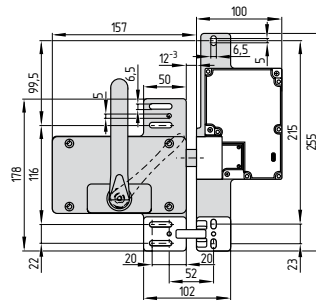

AZM 161-STS30-02/-07-R

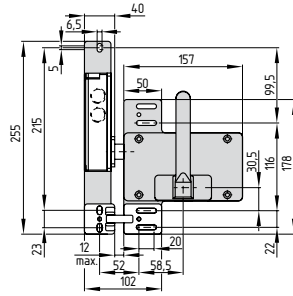

AZM 161-STS30-01/-08-R

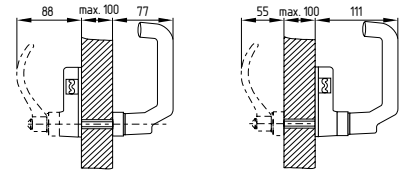
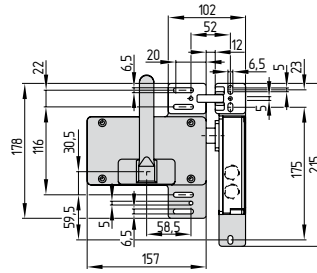

AZM 415-STS30-02/-04/-05/-07

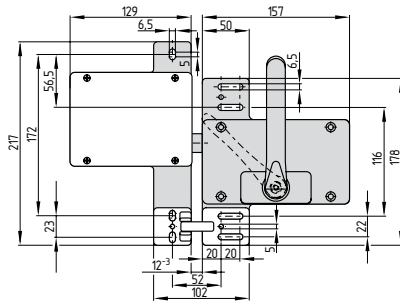

AZM 415-STS30-01/-03/-06/-08

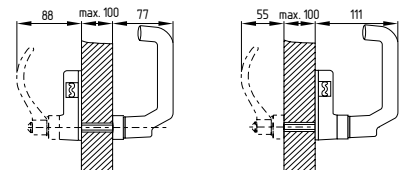
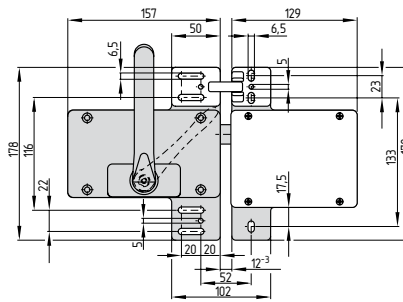

### 3.3 Mounting dimensions

	"a"	"x"	"y"
AZ 16	12 <sup>-3</sup> mm	5 mm	5 mm
AZ 3350	12 <sup>-3</sup> mm	12 mm	5 mm
AZ 415	12 <sup>-3</sup> mm	5 mm	5 mm
AZM 415	12 <sup>-3</sup> mm	5 mm	5 mm
AZM 161	12 <sup>-3</sup> mm	5 mm	5 mm

#### Legend

a	Maximum distance between switch and actuator
X	Thickness mounting plate actuator
Y	Thickness mounting plate door/emergency handle



When mounting the device, it must be observed that the actuator can be inserted stress-free into the safety switching component (e.g. by using an optional centring device). The observance of the clearance "a = 12<sup>-3</sup>" must be ensured, vertical or horizontal angular offset must be avoided.

3.4 Mounting steps - Outside mounting

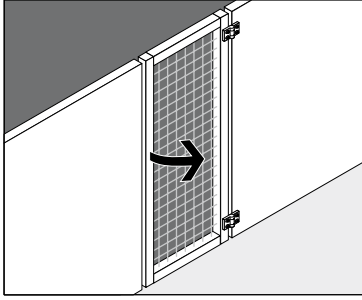

Step 1

- Fit actuator onto mounting plate

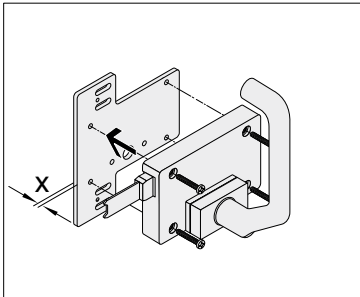

Step 2

- If used, fit lockout tag, fit door handle onto mounting plate MP TG-01

**To be observed**

- Refer to lockout tag mounting instructions

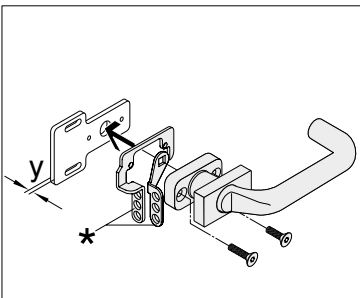

Step 3

- Cut the square bar to size
- To be observed**
- All measurements in mm
- with emergency handle:  $l = s + x + y + 82 + 4^*$
- without emergency handle:  $l = s + x + y + 69 + 4^*$
- Deburr the cut square bar

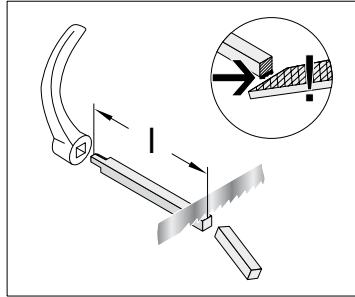

**Legend**

l	Long square bar
s	Thickness of the door
X	Thickness mounting plate actuator
Y	Thickness of the door handle/emergency handle mounting plate, if available; take two times "y", if the emergency handle mounting plate and the door handle mounting plate are installed
4*	only to be observed if a lockout tag is used

Step 4

- Insert square bar into actuator

**To be observed**

- Door handle must be in horizontal position
- If emergency handle available: observe the orientation of the square bar for the emergency handle (see drawing)

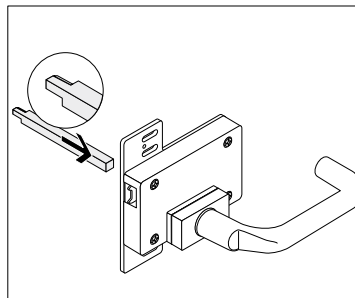

Step 5

- Mount switch onto mounting plate
- The mounting plate of the switch must be flush-mounted with the doorpost

**To be observed**

- Screws: M6
- Thread must be centric to the slotted holes of the mounting plate

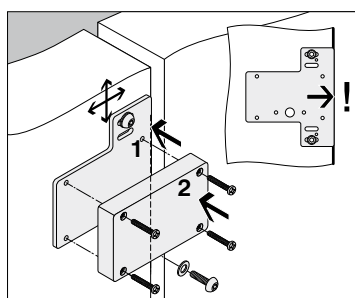

### Step 6

- Fit actuator to guard door and align

#### To be observed

- Actuator completely pulled out
- Insert actuator in switch housing
- Observe maximum distance "a" between switch and actuator, refer to "Dimensions" table
- Screws: M6
- Thread must be centric to the slotted holes of the mounting plate

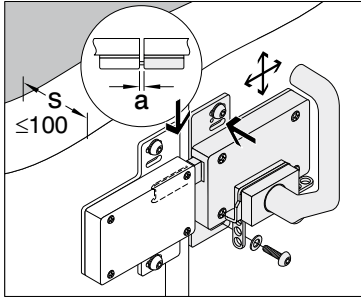

### Step 7

- If an emergency handle is used, screw emergency handle onto mounting plate

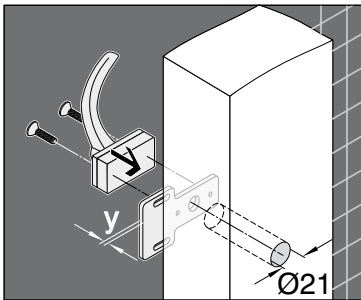

### Step 8

- Put emergency handle onto square bar
- Fit mounting plate with emergency handle onto guard door

#### To be observed

- Emergency handle and door handle must be in horizontal position when the emergency handle is put onto the square bar
- Screws: M6
- Thread must be centric to the slotted holes of the mounting plate

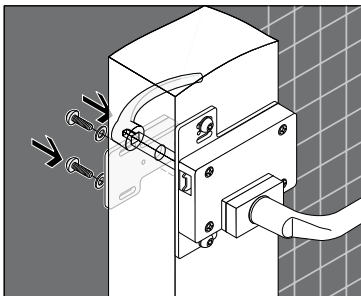

### 3.5 Mounting steps - Inside mounting

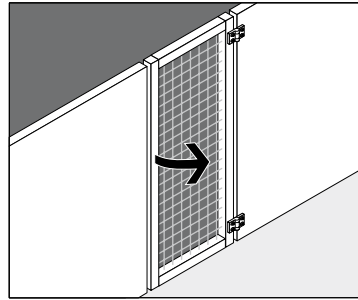

### Step 1

- Cut the square bar to size

#### To be observed

- All measurements in mm
- with emergency handle:  $l = s + x + y + 82 + 4^*$
- without emergency handle:  $l = s + x + y + 69 + 4^*$
- Deburr the cut square bar

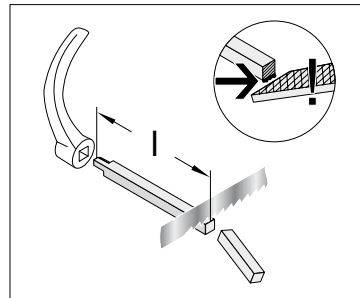

#### Legend

l	Long square bar
s	Thickness of the door
X	Thickness mounting plate actuator
Y	Thickness of the door handle/emergency handle mounting plate, if available; take two times "y", if the emergency handle mounting plate and the door handle mounting plate are installed
4*	only to be observed if a lockout tag is used

### Step 2

- Insert square bar into actuator

#### To be observed

- If emergency handle available: observe the orientation of the square bar for the emergency handle (see drawing)

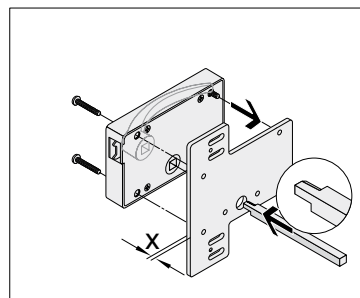

### Step 3

- If used, fit lockout tag

#### To be observed

- Refer to lockout tag mounting instructions

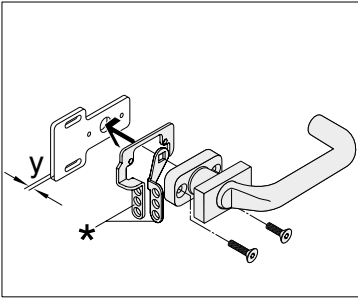

### Step 4

- Screw door handle onto mounting plate

#### To be observed

- Remove protection to screw the door handle

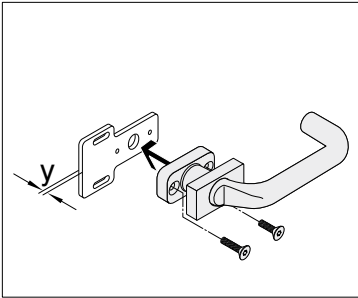

### Step 5

- The mounting plate of the switch must be flush-mounted with the doorpost
- Mount switch onto mounting plate

#### To be observed

- Screws: M6
- Thread must be centric to the slotted holes of the mounting plate

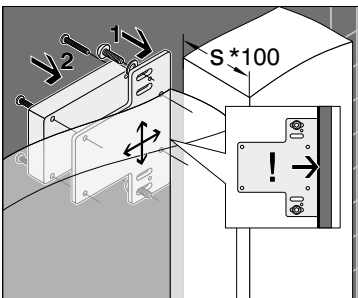

**K. A. Schmersal GmbH**  
**Industrielle Sicherheitssysteme**  
 Möddinghofe 30, D - 42279 Wuppertal  
 Postfach 24 02 63, D - 42232 Wuppertal

Phone: +49 - (0)2 02 - 64 74 - 0  
 Telefax: +49 - (0)2 02 - 64 74 - 1 00  
 E-Mail: [info@schmersal.com](mailto:info@schmersal.com)  
 Internet: <http://www.schmersal.com>

### Step 6

- Fit actuator to guard door and align

#### To be observed

- Actuator completely pulled out
- Insert actuator in switch housing
- Observe maximum distance "a" between switch and actuator, refer to "Dimensions" table
- Screws: M6
- Thread must be centric to the slotted holes of the mounting plate

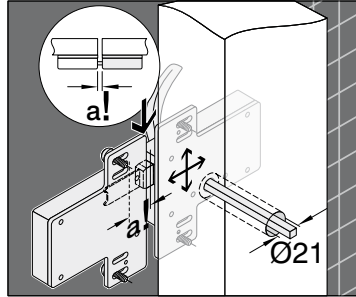

### Step 7

- Put door handle onto square bar
- Fit mounting plate to guard door

#### To be observed

- Emergency handle and door handle must be in horizontal position when the door handle is put onto the square bar
- Screws: M6
- Thread must be centric to the slotted holes of the mounting plate

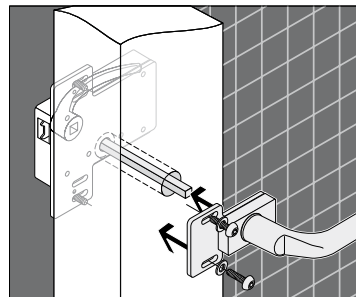

## 4. Set-up and maintenance

### 4.1 Functional testing

The safety function of the safety components must be tested. The following conditions must be previously checked and met:

1. Fitting of the safety switch/solenoid interlock and the actuator.
2. Check the integrity of the cable entry and connections
3. Check the switch enclosure for damage

### 4.2 Maintenance

We recommend a regular visual inspection and functional test, including the following steps:

1. Check for the integrity and correct installation of the actuator and the safety switch/solenoid interlock.
2. Check the clearance "a" and re-adjust if necessary; vertical or horizontal angular offset must be avoided
3. Remove particles of dust and soiling.
4. Check cable entry and connections.

**Damaged or defective components must be replaced.**